



**NAN HUA PRIMARY SCHOOL
SEMESTRAL ASSESSMENT 2 – 2015
PRIMARY 5**

SCIENCE

BOOKLET A

30 Multiple Choice Questions (60 marks)

Total Time for Booklets A and B : 1 hour 45 minutes

INSTRUCTIONS TO CANDIDATES

1. Write your name and index number in the space provided.
2. Do not turn over the page until you are told to do so.
3. Follow all instructions carefully.
4. Answer all questions.
5. Shade your answers in the Optical Answer Sheet (OAS) provided.

Marks Obtained

Booklet A		/ 60
Booklet B		/ 40
Total		/ 100

Name: _____ () **Class: P 5** _____

Date : 29 October 2015

Parent's Signature: _____

Section A: (30 x 2 marks = 60 marks)

For each question from 1 to 30, four options are given. One of them is the correct answer. Make your choice (1, 2, 3 or 4). Shade the correct oval (1, 2, 3 or 4) on the Optical Answer Sheet.

1. The diagram below shows a female reproductive system. A, B, C and D are different parts of the reproductive system.

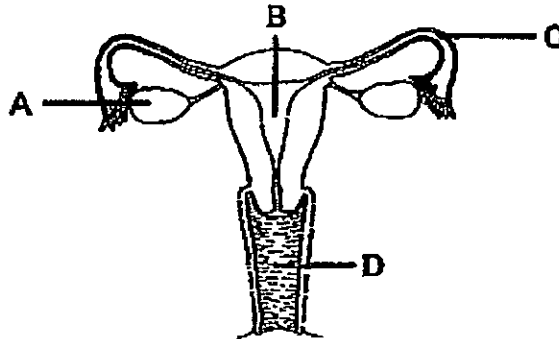

At which part, A, B, C or D, does a fertilised egg develop into a baby?

- (1) A
- (2) B
- (3) C
- (4) D

2. The table below compares the sexual reproduction of animals and flowering plants.

	Animals	Flowering plants
Organ that produces the female reproductive cell	Ovary	W
Organ that produces the male reproductive cell	X	Y
Process whereby the female reproductive cell fuses with the male reproductive cell	Z	Z

Which one of the following correctly identifies W, X, Y and Z?

	W	X	Y	Z
(1)	Ovary	Testis	Anther	Fertilisation
(2)	Stigma	Testis	Anther	Pollination
(3)	Ovary	Anther	Testis	Reproduction
(4)	Stigma	Testis	Anther	Fertilisation

3. Some Primary 5 pupils wanted to carry out an experiment to find out whether seeds need water to germinate.

placed inside the classroom

placed outside the classroom

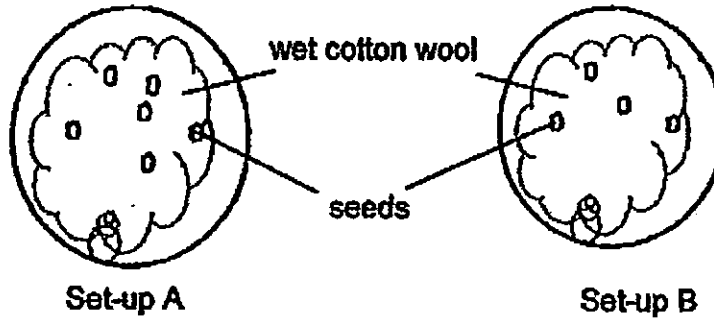

placed inside the classroom

placed outside the classroom

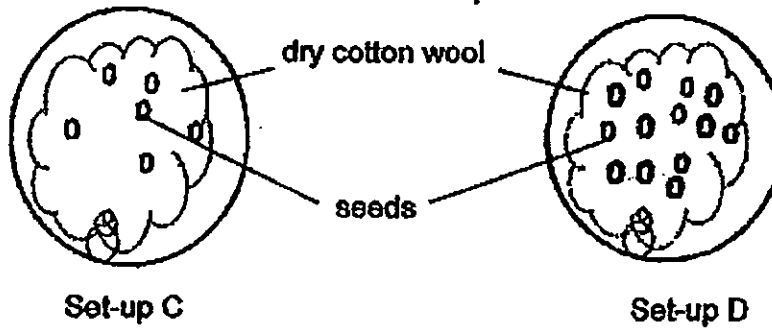

To ensure a fair test, which 2 set-ups should they use?

- (1) A and C only
- (2) A and D only
- (3) B and C only
- (4) B and D only

4. The diagram below shows a plant cell with its different parts labelled.

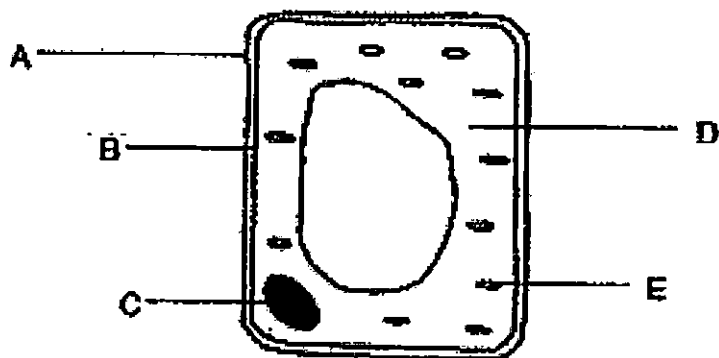

Which parts of the cell, if removed, will result in the effects as shown in the table below?

	Cell will not have a regular shape	Plant will not be able to make food
(1)	A	E
(2)	C	B
(3)	B	D
(4)	D	C

5. Kok Fah wants to grow apples that are redder and sweeter.

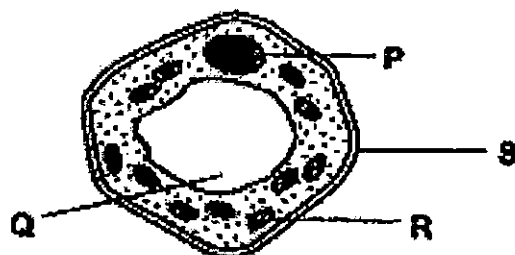

Based on the plant cell given above, which part(s) of the cell is/are most likely to have been changed in order to produce such apples?

- (1) P only
- (2) S only
- (3) P and R only
- (4) Q and S only

6. Study the circuit diagram below.

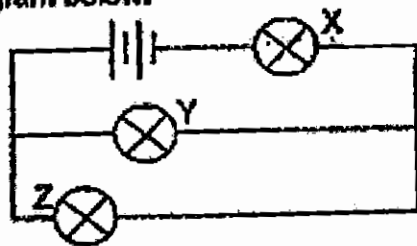

Which of the bulb(s) will remain lit when bulb Z fuses?

- (1) X only
- (2) Y only
- (3) X and Y
- (4) None of the bulbs.

7. There are four circuits with different number of identical batteries and different arrangements of identical bulbs shown below. The bulbs in all four circuits light up.

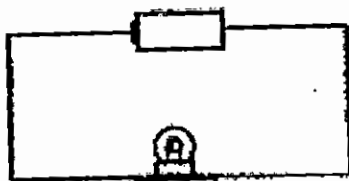

Set-up A

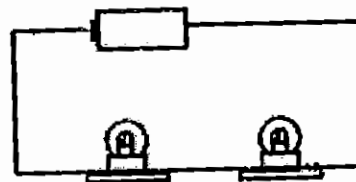

Set-up B

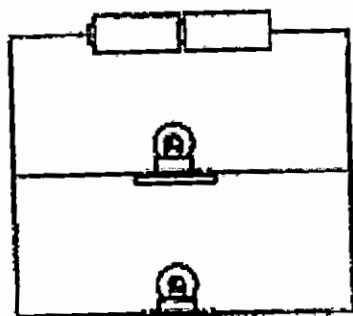

Set-up C

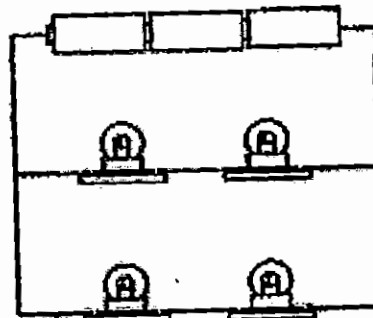

Set-up D

Arrange the set-ups based on the brightness of the bulb.

		Brightness of bulb			
		Dimmest	→		Brightest
(1)	A	B	C	D	
(2)	B	C	D	A	
(3)	D	C	B	A	
(4)	B	A	D	C	

8. Which of the following statements about green plants are correct?

- A They need energy to carry out life processes.
- B Photosynthesis takes place in the presence of sunlight only.
- C Food produced by green plants directly or indirectly becomes the source of energy for animals.
- D Exchange of gases like carbon dioxide, oxygen and water vapour takes place in all parts of green plants.

- (1) A and B only
- (2) A and C only
- (3) B and D only
- (4) C and D only

9. A group of Primary 5 pupils wrote the following statements about the water cycle.

- A Water gains heat and evaporates.
- B Clouds are made up of water vapour.
- C Plants and animals give out water vapour.
- D The two processes, evaporation and condensation, take place continuously in a cycle.

Who is/are correct?

- (1) A only
- (2) B only
- (3) A, C and D only
- (4) A, B, C and D

10. The table below shows a list of different functions of the various parts of a land plant.

A	makes food for the plant
B	takes in water and mineral salts
C	contains and protects the seeds
D	holds the plants firmly to the ground
E	supports and spreads out the branches and leaves
F	transports food, water and mineral salts to all parts of the plant.

Which one of the following parts of the plant is matched correctly to its functions?

	Part of plant	Functions
(1)	Fruit	A and C
(2)	Stem	E and F
(3)	Leaf	A and B
(4)	Root	D and E

11. The diagram below shows the digestive system of a human body.

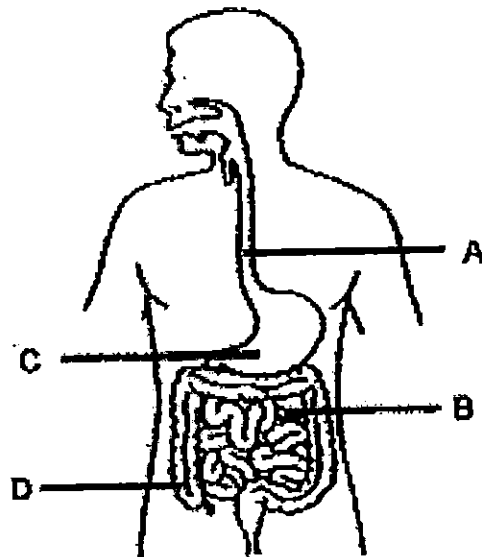

At which part, A, B, C or D, is digested food absorbed into the bloodstream?

- (1) A
- (2) B
- (3) C
- (4) D

12. In one of Aesop's Fables, 'The Crow and the Pitcher', the thirsty crow dropped in pebbles one by one into the pitcher until the water rose to the top of the pitcher, allowing it to drink.



Which property of matter did the crow use to obtain water?

- (1) Matter has mass.
- (2) Matter occupies space.
- (3) Matter has definite shape.
- (4) Matter takes the shape of the container.

13. The diagram below shows the cross-section of a lady's finger.



Pupils A, B and C wrote the following statements after looking at the lady's finger.

- A The lady's finger is not a fruit but a vegetable.
- B The function of the fruit is to protect the seeds.
- C The ovary of the flower which the lady's finger developed from contained many ovules.

Whose statement(s) is/are correct?

- (1) A only
- (2) C only
- (3) A and B only
- (4) B and C only

14. The diagrams below show the fruits of three different plants and their characteristics.

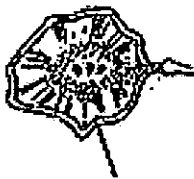

wing-like structure

Plant A



stiff hair

Plant B



fruit dries up when ripe

Plant C

The following diagrams show three possible dispersal patterns, X, Y and Z.

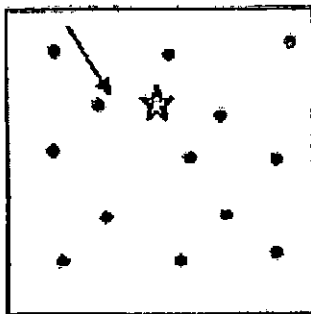

X

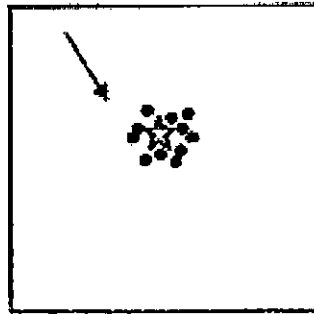

Y

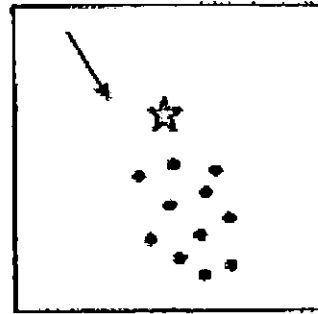

Z



Which one of the following best matches the dispersal pattern to the plants, A, B and C?

	Pattern X	Pattern Y	Pattern Z
(1)	Plant A	Plant B	Plant C
(2)	Plant B	Plant C	Plant A
(3)	Plant C	Plant A	Plant B
(4)	Plant C	Plant B	Plant A

15. The diagram below shows the movement of blood through different blood vessels in the leg of a mammal.

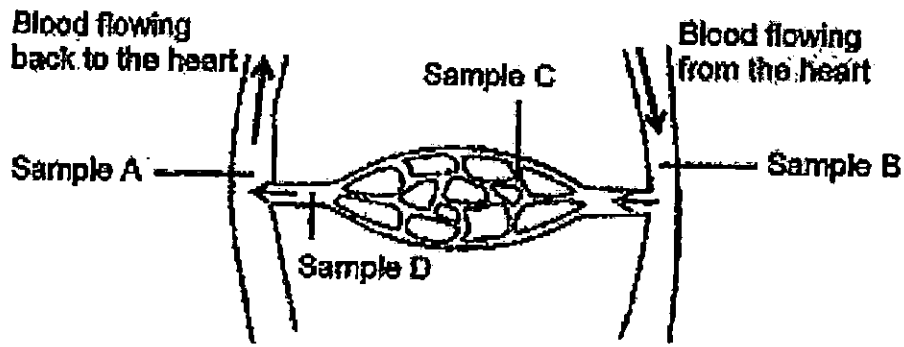

Blood samples A, B, C and D were taken from these different blood vessels. Which graph most appropriately shows the amount of carbon dioxide in the blood samples?

(1)

Amount of carbon dioxide

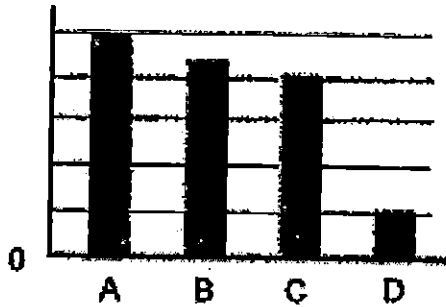

(2)

Amount of carbon dioxide

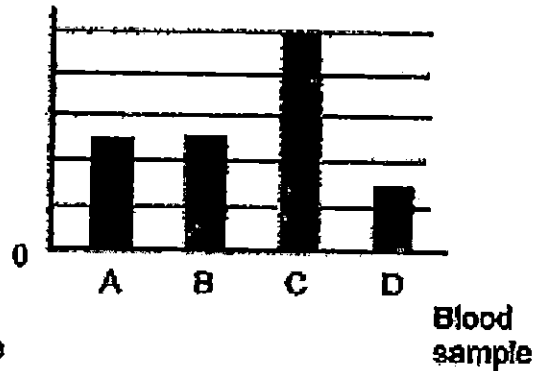

(3)

Amount of carbon dioxide

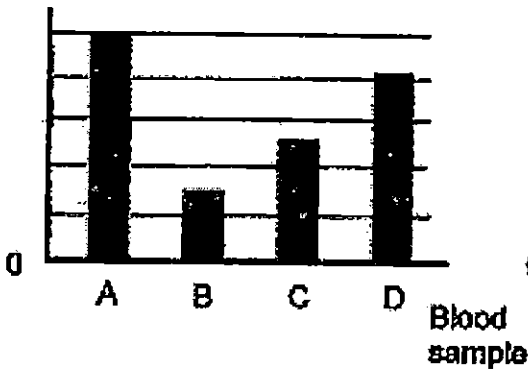

(4)

Amount of carbon dioxide

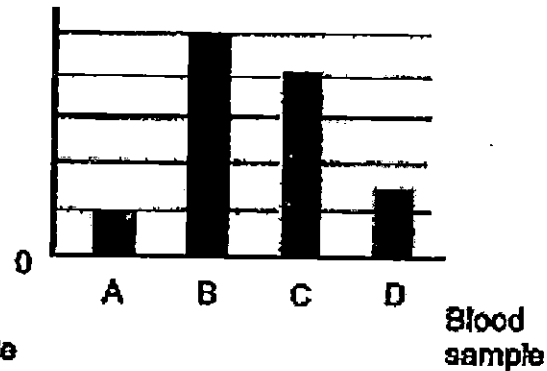

16. Which of the following substances are transported by the blood vessels in the human body and the water-carrying tubes in a green plant respectively?

- A food
- B water
- C gases
- D mineral salts

	Blood vessels in the human body	Water-carrying tubes in a green plant
(1)	A and D only	B and C only
(2)	A, B and C only	B only
(3)	A, B, C and D	A and C only
(4)	A, B, C and D	B and D only

17. Study the flowchart of the human systems as shown below.

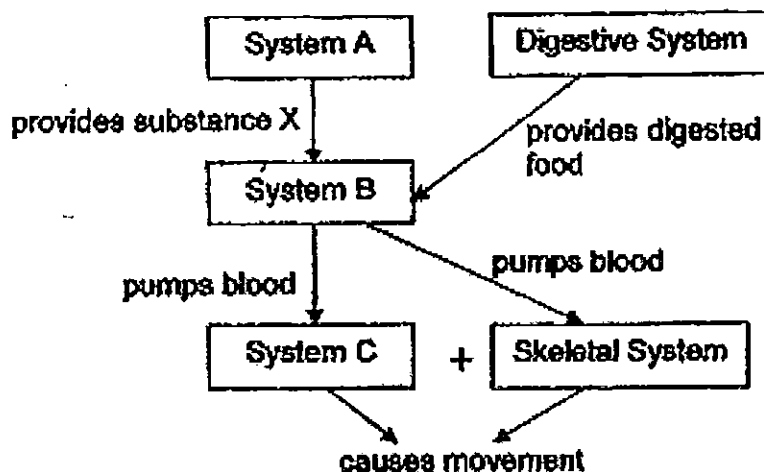

Which systems do A, B and C represent and what is substance X?

	System A	System B	System C	Substance X
(1)	respiratory system	circulatory system	muscular system	oxygen
(2)	circulatory system	respiratory system	muscular system	oxygen
(3)	circulatory system	muscular system	respiratory system	carbon dioxide
(4)	respiratory system	circulatory system	muscular system	carbon dioxide

18. Lungs are the organs in the respiratory system of a mammal. Gills are the organs in the respiratory system of a fish.

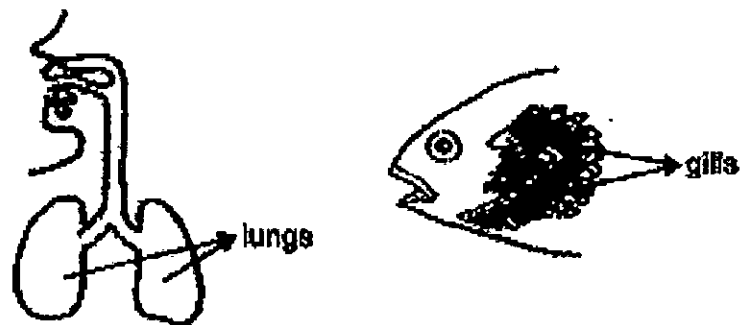

Which of the following statements show the comparisons between the lungs and the gills correctly?

- A The lungs and the gills are made up of blood vessels only.
- B The exchange of gases takes place in both the lungs and the gills.
- C The lungs and the gills remove the carbon dioxide from the body.
- D The lungs take in atmospheric oxygen but the gills take in dissolved oxygen.

- (1) A and B only
- (2) A and C only
- (3) B, C and D only
- (4) A, B, C and D

19. Study the diagrams below.

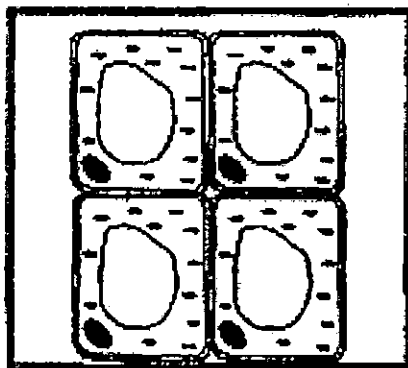

Cell X

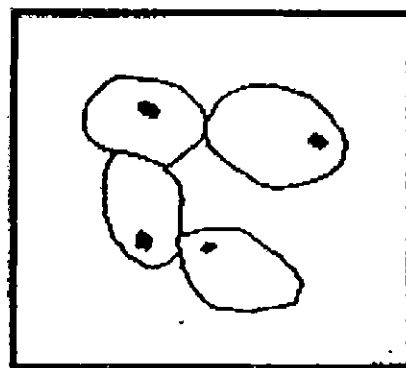

Cell Y

Cell X and Cell Y are similar because they both _____.

- (1) have a regular shape
- (2) do not have cell membrane
- (3) have chloroplasts to make their own food
- (4) have cytoplasm that contains the different cell parts

20. A circuit card consisting of 6 paper clips (P1 to P6) are connected by 3 copper wires and 3 nylon strings. A group of pupils connected the circuit card to a circuit tester.

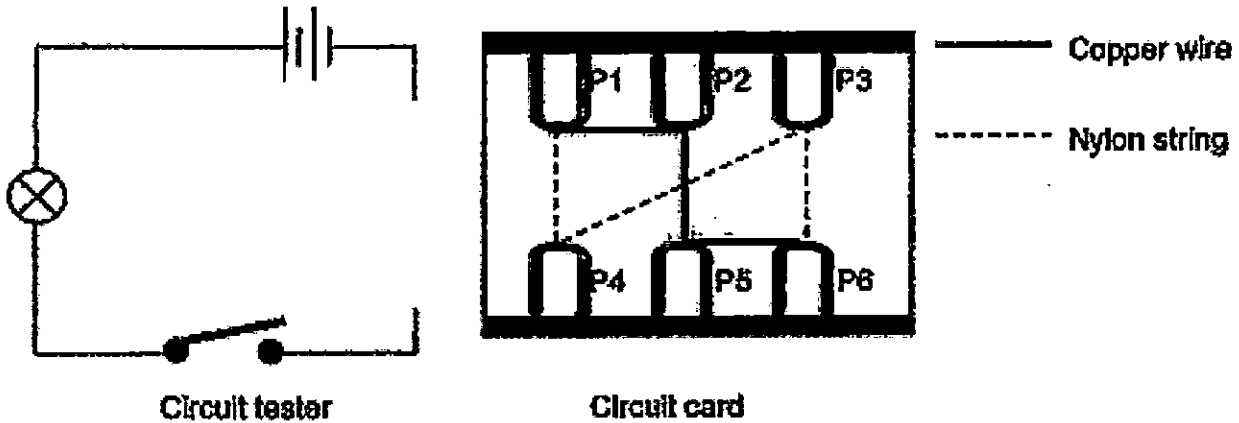

For the bulb to light up, which pair of paper clips on the circuit card should the pupils connect to the circuit tester?

- (1) P1 and P6
- (2) P2 and P4
- (3) P3 and P5
- (4) P3 and P6

21. Uncle Bob set up the experiments as shown below. Set-up A and Set-up B allowed him to compare materials R, S, T and U in terms of their conductivity of electricity and heat respectively.

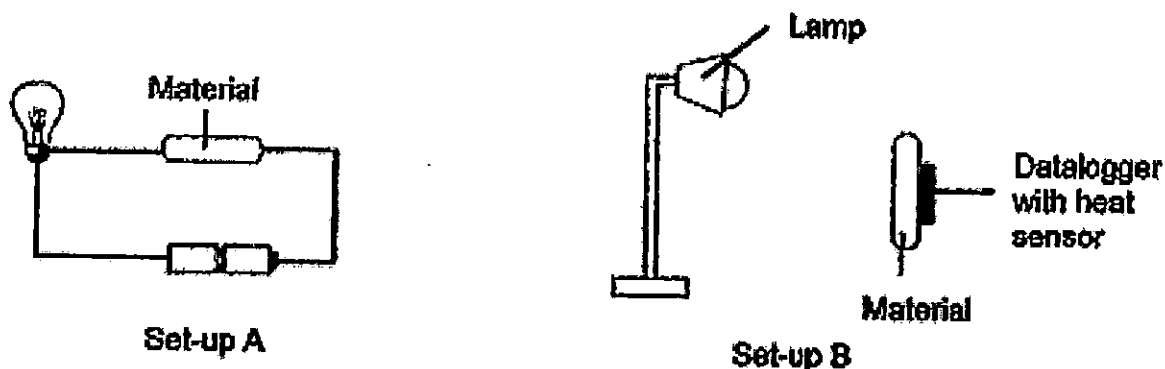

He recorded his findings from Set-up A in the table below.

Materials	Brightness of the bulb
R	Dim
S	Very bright
T	No light
U	Bright

The graph below shows the results for Set-up B.

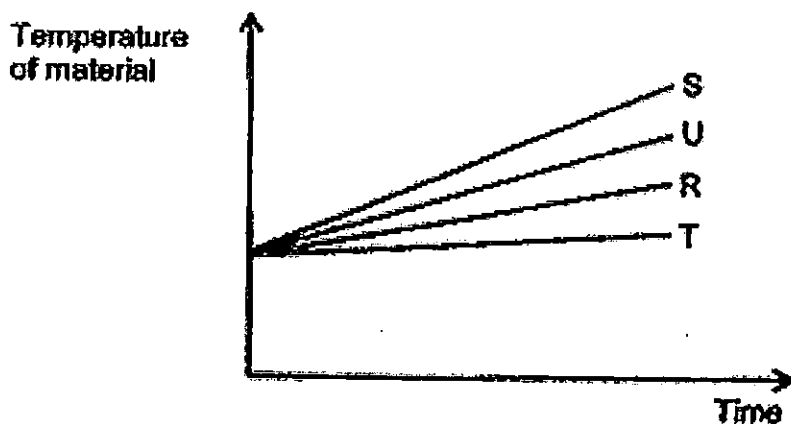

Which of the following statements is correct?

- (1) Material R is an insulator of electricity and a good conductor of heat.
- (2) Material S is the best conductor of electricity and heat among the 4 materials.
- (3) Material T is the poorest conductor of electricity but the best conductor of heat.
- (4) Material S is a better conductor of electricity than Material T but a poorer conductor of heat than Material T.

22. Mary tested the switches of 4 circuits and recorded her observations in the table below.

Switch X	Switch Y	Number of bulbs lighted up
Open	Open	0
Closed	Open	1
Open	Closed	1
Closed	Closed	2

Which one of the electric circuits shown below will produce the results in the table above?

(1)

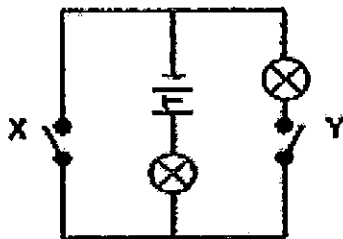

(2)

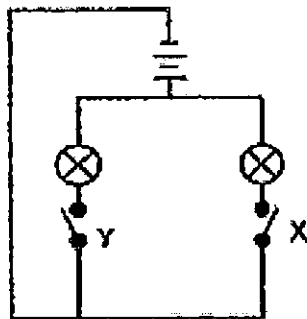

(3)

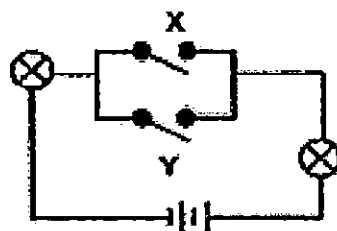

(4)

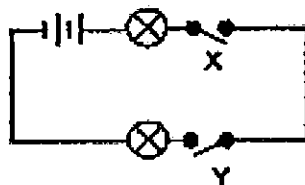

23. In the circuit shown below, one of the 4 objects, A, B, C or D, is an electrical insulator. If the switch is closed, only 3 bells in the circuit will ring.

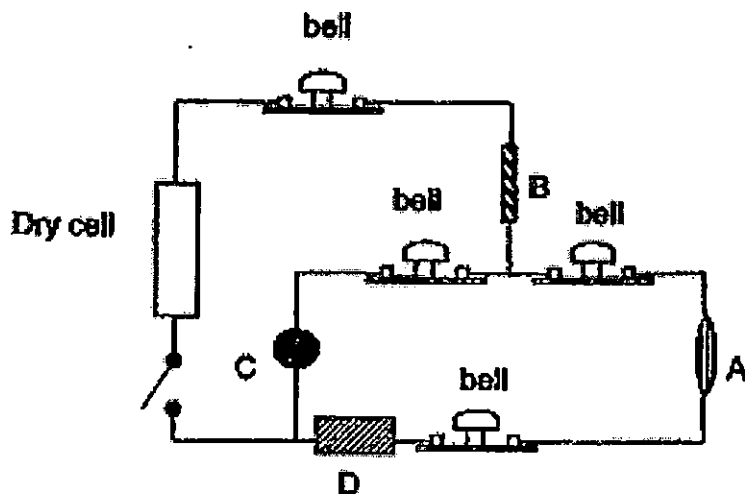

Which one of the 4 objects, A, B, C or D, is the electrical insulator?

- (1) Object A
- (2) Object B
- (3) Object C
- (4) Object D

24. The table below shows the boiling and melting points of three substances.

Substance	Melting point ($^{\circ}\text{C}$)	Boiling point ($^{\circ}\text{C}$)
P	8	50
Q	40	180
R	160	320

Based on the information given above, which one of the following shows the correct states of Substances P, Q and R at a room temperature of 28°C ?

- | | Solid | Liquid |
|-----|---------|---------|
| (1) | R | P and Q |
| (2) | P and R | Q |
| (3) | P | Q and R |
| (4) | Q and R | P |

25. Mr Lim watered a potted plant and wrapped it with a black plastic bag. Then he placed it under the Sun for several hours.

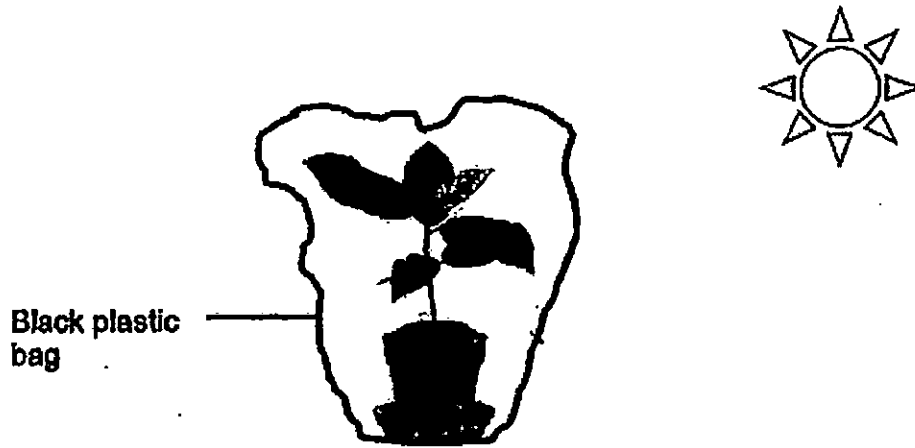

Which one of the following graphs below shows the changes in the amount of carbon dioxide and oxygen in the bag during that period of time?

(1)

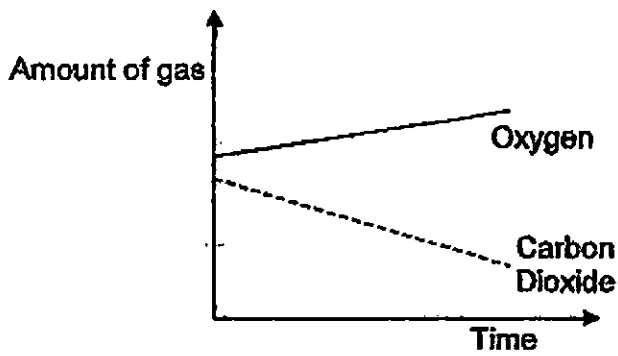

(2)

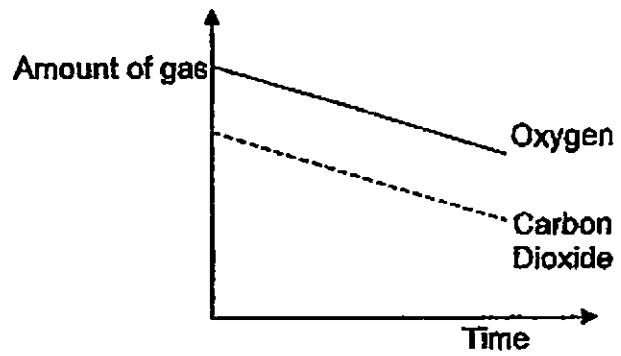

(3)

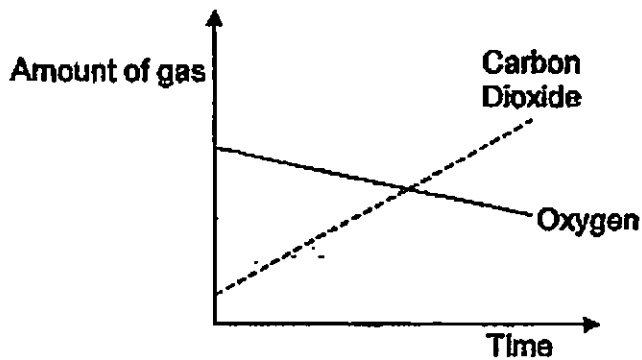

(4)

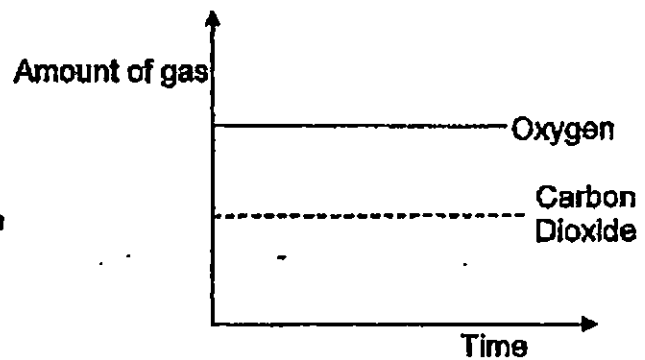

26. Mdm Halimah heated some water in a kettle until it boiled. She forgot to turn off the fire and the water continued to boil for some time. After she had switched off the fire, she left the water to cool. The graph below shows the change in the temperature of the water over a period of time.

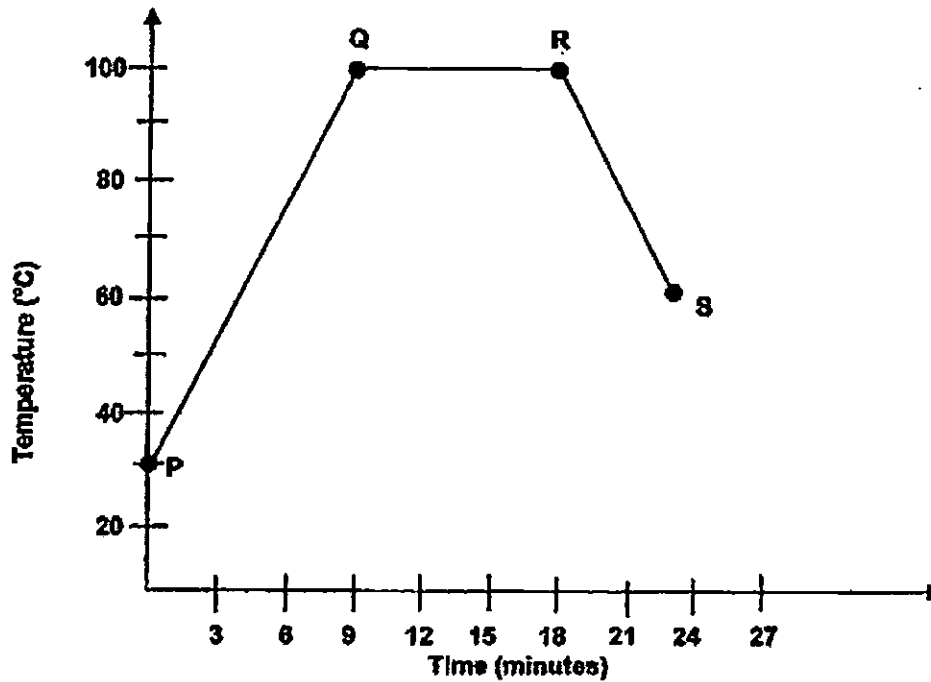

Which of the following statements correctly show what happened to the water at the different stages?

- A Heat was gained at stage QR.
 - B Water was heated for 18 minutes.
 - C Water could exist in 2 states at stage PQ.
 - D Evaporation took place at stage RS only.
- (1) A and B only
(2) C and D only
(3) A, C and D only
(4) A, B and C only

27. The diagram below shows what happened to 3 identical bar magnets when they were hung from a pole. The ends of the bar magnets are marked A to F.

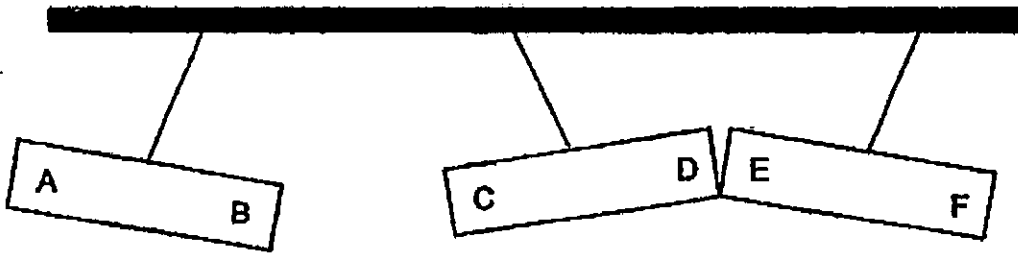

Which one of the following diagrams shows a possible arrangement of the three magnets?

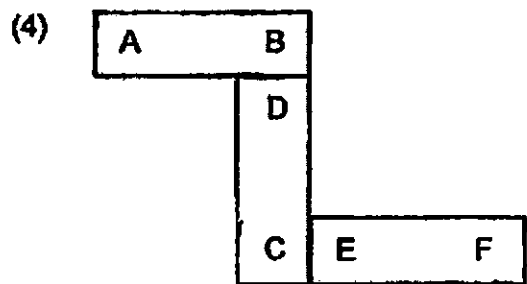
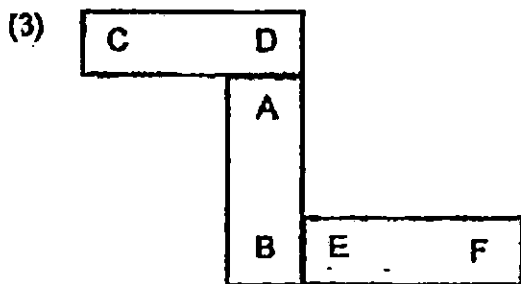
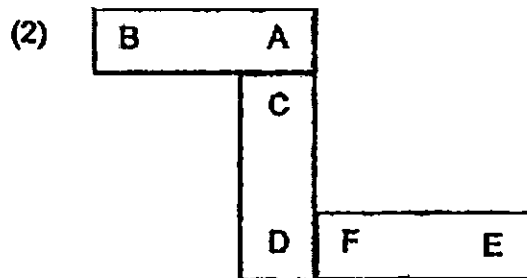
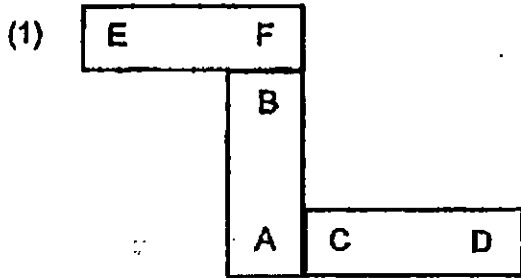

28. The diagram below shows the life cycle of a fern.

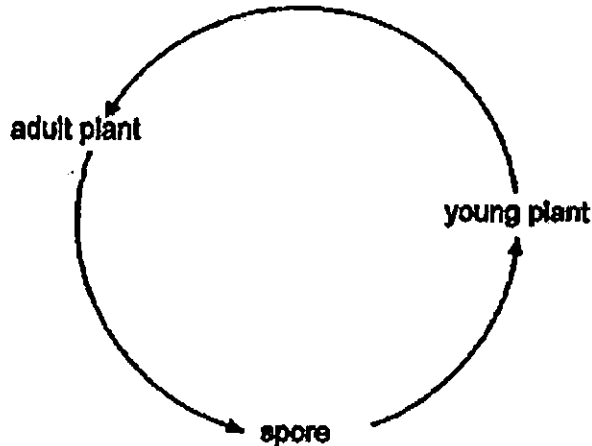

Which one of the following statements about the life cycle of the fern is incorrect?

- (1) All ferns go through the same life cycle.
- (2) There are three stages in the life cycle of the fern.
- (3) The life cycle of the fern ensures the continuity of its kind.
- (4) Sunlight is not needed for each stage of growth of the fern.

29. A container with a capacity of 1000 cm^3 is fitted with a pump. Each time the plunger is pushed in completely, 150 cm^3 of air will enter the container.

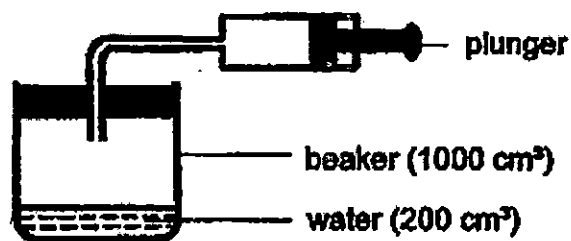

What will be the volume of the air in the beaker if the plunger is pushed in 3 times?

- (1) 450 cm^3
- (2) 650 cm^3
- (3) 800 cm^3
- (4) 1000 cm^3

30. The pupils in 5A studied the life cycle of Insect A and Insect B shown below.

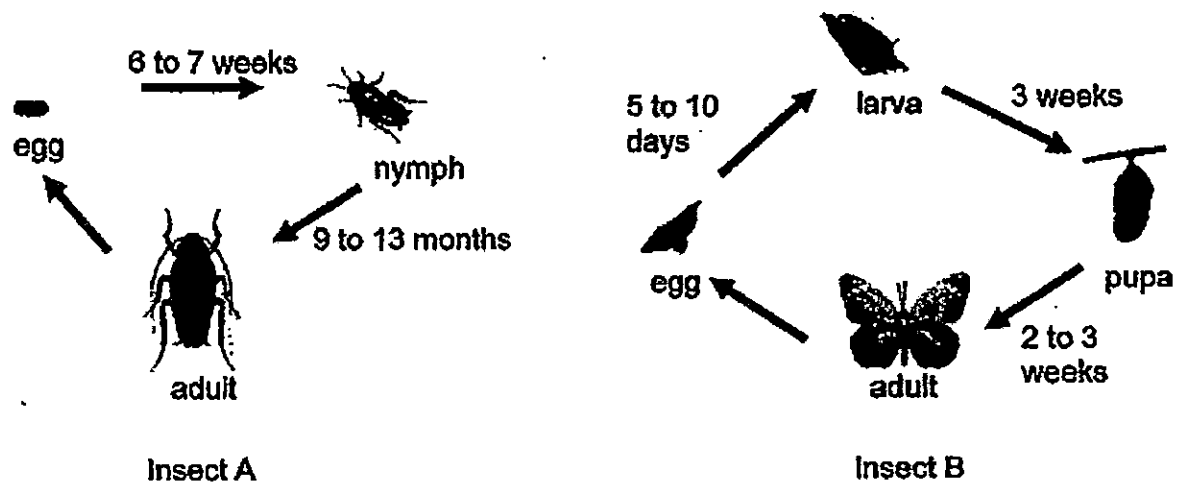

From the information provided in the 2 life cycles above, what can the pupils compare about them?

- A The food the two insects eat
 - B The method of reproduction
 - C The number of stages in the life cycle
 - D The length of time it takes for the eggs to hatch
-
- (1) C only
 - (2) B and C only
 - (3) B, C and D only
 - (4) A, B and C only



**NAN HUA PRIMARY SCHOOL
SEMESTRAL ASSESSMENT 2 – 2015
PRIMARY 5**

SCIENCE

BOOKLET B

14 Open-ended questions (40 marks)

Total Time for Booklets A and B : 1 hour 45 minutes

INSTRUCTIONS TO CANDIDATES

1. Write your name and index number in the space provided.
2. Do not turn over the page until you are told to do so.
3. Follow all instructions carefully.
4. Answer all questions.
5. Write your answers in this booklet.

Marks Obtained

Section B

	/ 40
--	------

Name: _____ () **Class: P 5** _____

Date : 29 October 2015

Parent's Signature: _____

Section B: (40 marks)

Write your answers to questions 31 to 44. The number of marks available is shown in brackets [] at the end of each question or part-question.

31. The diagram below shows an important process in the sexual reproduction of flowering plants.

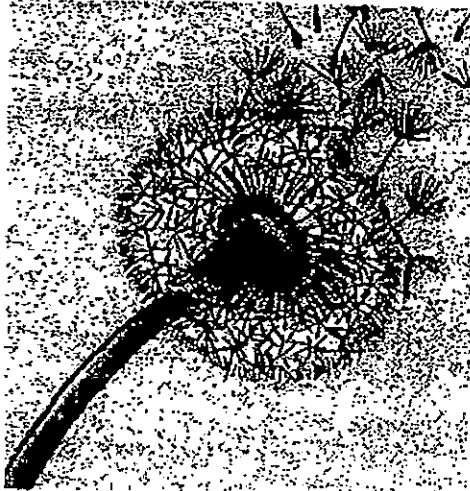

- a) State the process in the above diagram. [1]

- b) If conditions are favourable, what is the next process that would take place? [1]

Score	2
-------	---

32. The table below shows the composition of air in Country P and Country Q.

Country	Composition of air
P	78% Nitrogen 21% Oxygen 0.5% Water vapour 0.5% Carbon dioxide and other gases
Q	78% Nitrogen 21% Oxygen 0.2% Water vapour 0.8% Carbon dioxide and other gases

The percentage of water vapour in the air is known as humidity. The higher the humidity, the slower the rate of evaporation.

In which country would the drying of wet clothes take a shorter period of time? Explain your answer. [2]

Score	2
-------	---

33. Hui Wen conducted an experiment to find out the function of various cell parts. She placed a plant cell, as shown below, in a dish with a solution containing Chemical X. When she checked the cell after an hour, she found that Chemical X did not enter the cell. The experiment was then repeated with another four similar cells, with each cell having a part removed.

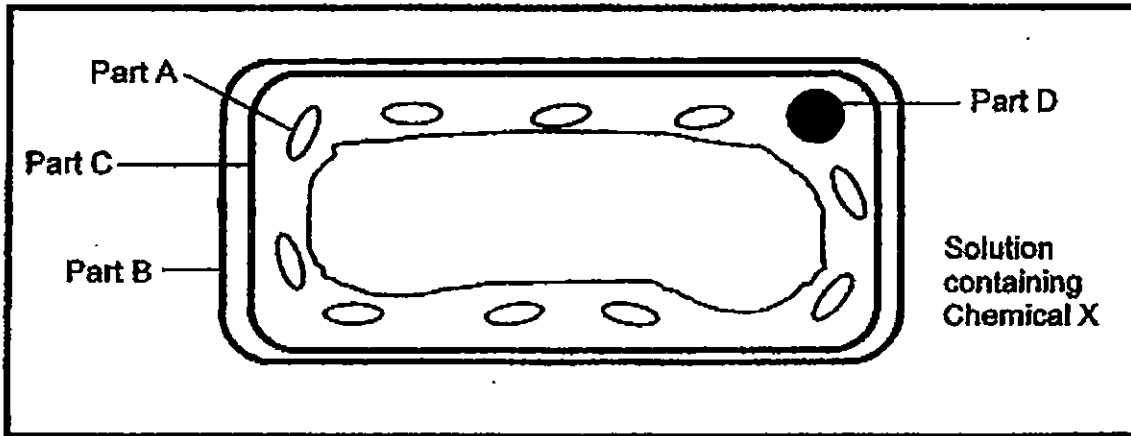

The table below shows part of her results. Complete it to show the results when various parts of the cells are removed. [2]

	Cell part removed	Is Chemical X found in the cell?
	None	No
(i)	Part A	
(ii)	Part B	
(iii)	Part C	
(iv)	Part D	

Score	2
-------	---

34. Greg wants to check if both of the bulbs are working. He decided to set up a simple circuit to test both bulbs at the same time to check if the bulbs are in working condition. He has the following components to set up the circuit.

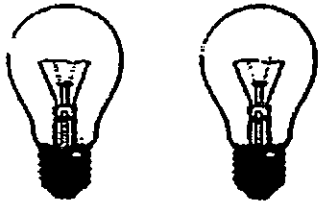

Two light bulbs



One battery



Unlimited number of wires

In the box below, draw a circuit diagram to show how Greg should connect all the components so that he could test the bulbs at the same time to determine if they work. [2]

Score	2
-------	---

35. Two ice cubes made of pure water and of the same mass were placed in a plastic cup and a metal cup respectively once they had been removed from the freezer. The ice cubes in the plastic cup and metal cup were left in a room with a temperature of 27°C for two minutes.

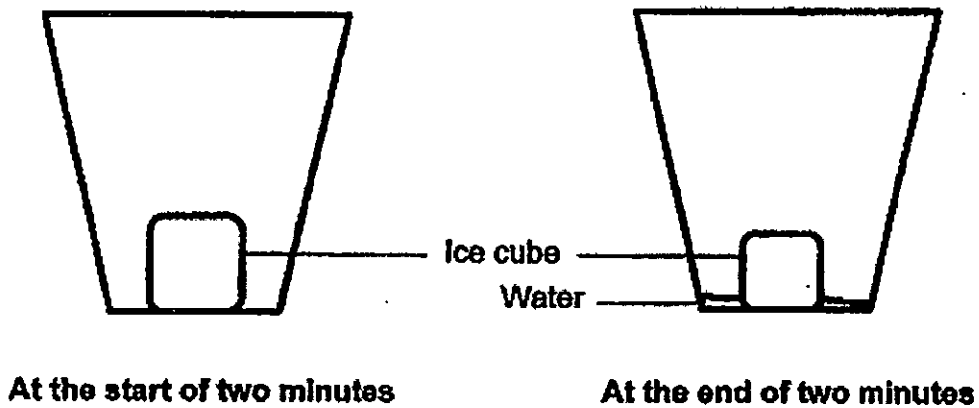

a) What is the temperature of the ice cube at the end of 2 minutes? [1]

b) The time taken for the ice cubes to melt completely in both the plastic and metal cups is recorded in the table below. Identify the materials of the cups in the table below. [1]

	Material of cup	Time taken (minutes)
i		14
ii		10

c) Explain your answer in (b). [1]

Score	/
	3

36. The diagram below shows the family tree of Isaac.

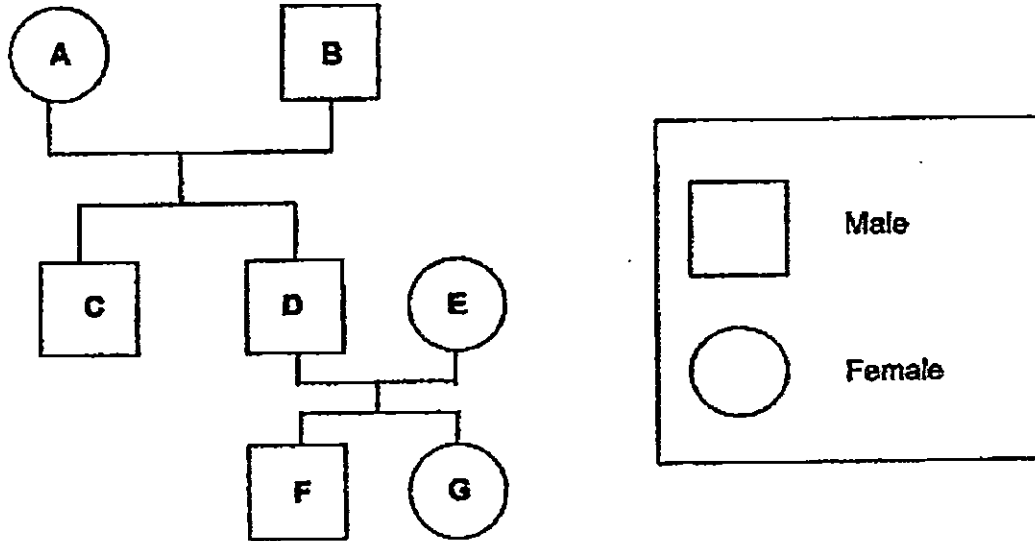

Family Member	Characteristic		
	Dimpled Cheeks	Widow's Peak	Single Eyelids
A	✓		✓
B		✓	
C			✓
D		✓	
E	✓		✓
F			✓
G	✓	✓	✓

a) Isaac belongs to the second generation. He inherited his widow's peaks from his father but did not inherit his mother's dimpled cheeks. Which letter in the family tree represents Isaac? [1]

b) Study the family tree. Explain why F and G have single eyelids. [1]

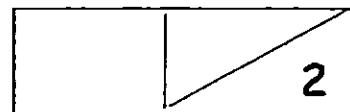

37. Joanne placed the following single-cell organism in a dish.

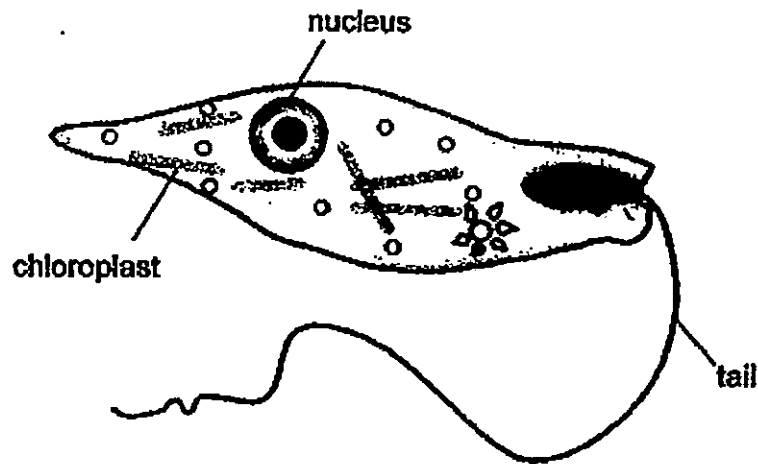

a) It is observed that the cell moves towards light. Using the knowledge of the function of each cell part within the organism, explain this observation. [2]

b) State two substances that would be produced within the single-cell organism after a few hours in the presence of light. [1]

c) Do you think the tail of the organism could function if its nucleus is removed? Give a reason for your answer. [1]

Score	/
	4

38. Glenn set up an experiment in which he placed rods of different materials in four different circuits. Each circuit was connected to a meter that measured the amount of electric current passing through it.

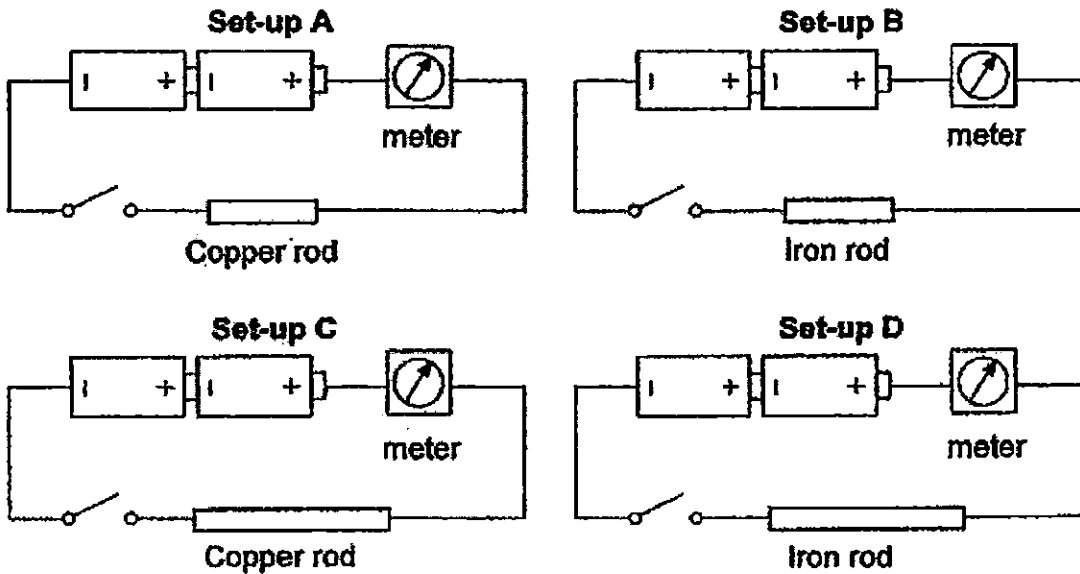

- a) Glenn wanted to find out whether different materials will affect the amount of electricity that passes through the circuit. Which two set-ups should he use? [1]

- b) Glenn used set-up B and set-up D for another experiment. What is the aim of this experiment? [1]

- c) Why is a meter better than a light bulb in determining the amount of electric current passing through the circuit in this experiment? [1]

Score	3
-------	---

39. Gary set up the circuit as shown below to test if Objects A, B and C are made of electrical conductors. The different objects were connected to the circuit at testing positions J, K and L.

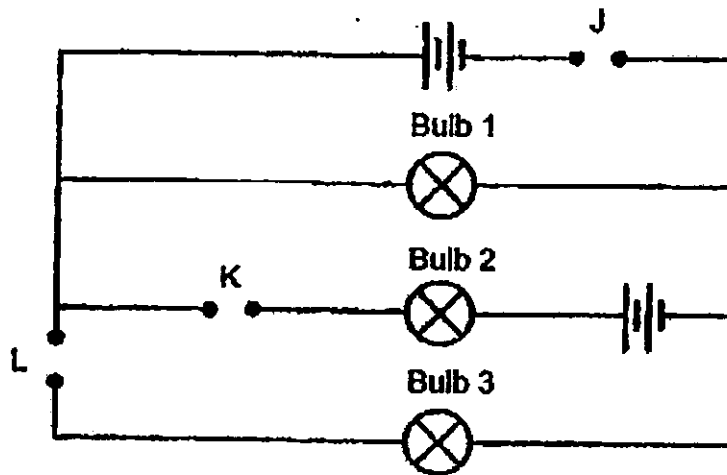

- a) Gary's teacher commented that one of the testing positions chosen is unsuitable in confirming if all three objects tested at the same time are electrical conductors.

i) Which testing position, J, K or L, is unsuitable? [1]

- ii) Mark an "X" on the above circuit to show where the new testing position should be so that all three objects could be tested at the same time. [1]

b) The findings are recorded in the table below.

Objects placed at			Does the bulb light up?		
J	K	L	Bulb 1	Bulb 2	Bulb 3
A	B	C	Yes	No	Yes
B	A	C	No	Yes	Yes

i) Based on the table above, which object(s) is/are electrical insulator(s)? [1]

ii) Name a possible material that the object(s) mentioned in b(i) is/are made of. [1]

Score	4
-------	---

40. Hazel set up an experiment in a dark room to find out which coloured light(s), red, green or blue, could be used for photosynthesis.

She divided a tank into three sections, A, B and C, by black plastic sheets as shown in the diagram below.

She introduced some fish into each section which had water plant with same number of leaves.

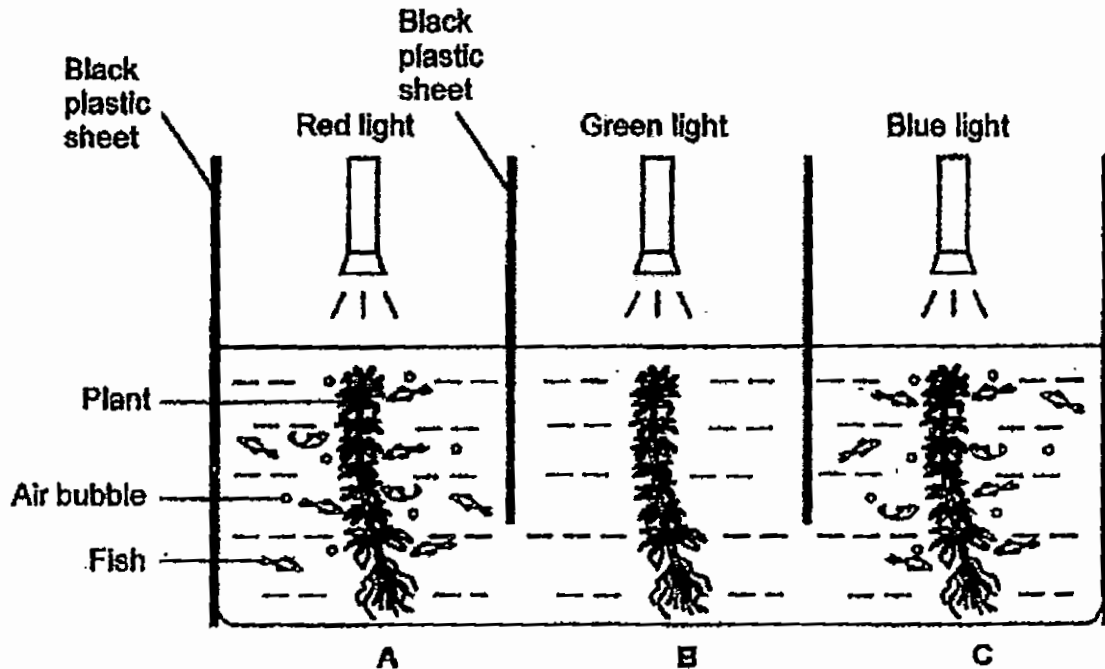

a) Give a reason why the fish were found in sections with red and blue light only. [1]

b) Which coloured light(s) could be used for photosynthesis? [1]

c) Hazel's teacher suggested that she repeat her experiment with the same set up. What is the purpose of repeating her experiment? [1]

Score	3
-------	---

41. Grace studied how the rate of photosynthesis of Plant X and Plant Z is affected by different light intensities. The graph below shows her results.

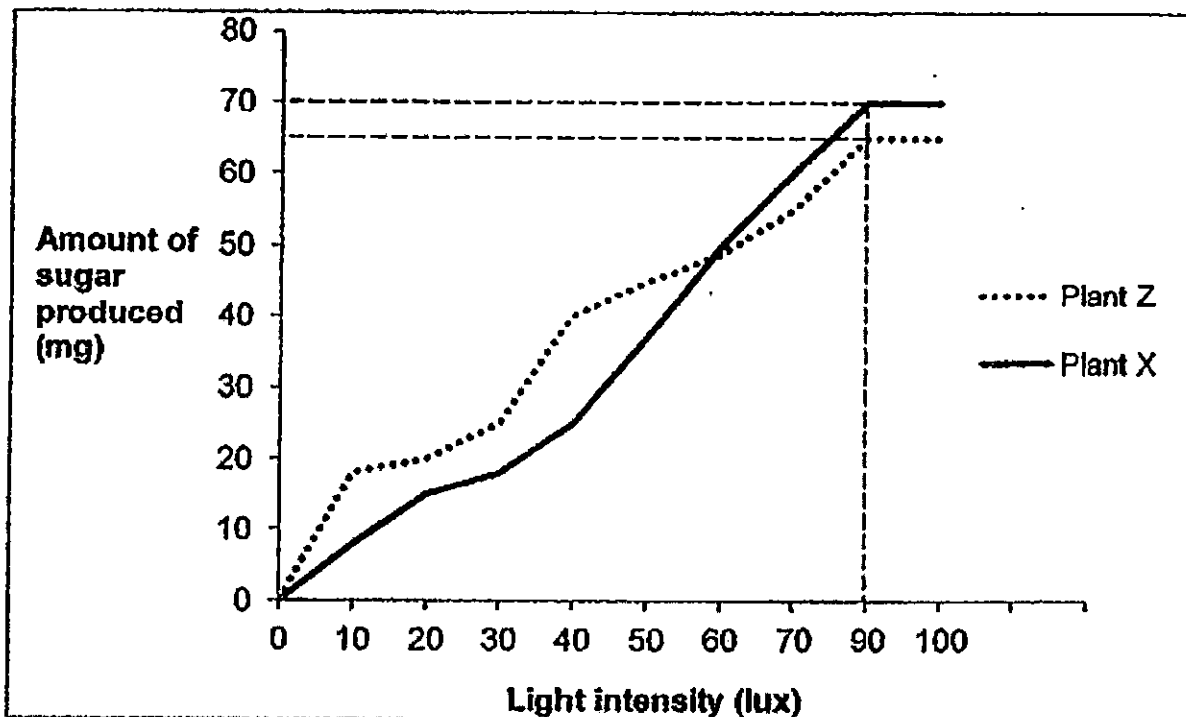

a) State the relationship between light intensity and the rate of photosynthesis of Plant Z from 0 lux to 100 lux. [2]

b) Based on the results from the graph, suggest which plant is more suitable to be grown in a shaded location? Explain your answer. [1]

c) Predict the amount of sugar produced by both plants when the light intensity is increased to 100lux for each plant. [1]

i) Plant X: _____ mg

ii) Plant Z: _____ mg

Score	4
-------	---

42. The diagram below shows a water cone that allows clean drinking water to be collected from the ground.



On a sunny day, the water cone is placed on wet ground. Water will be collected at the base of the cone after many hours.

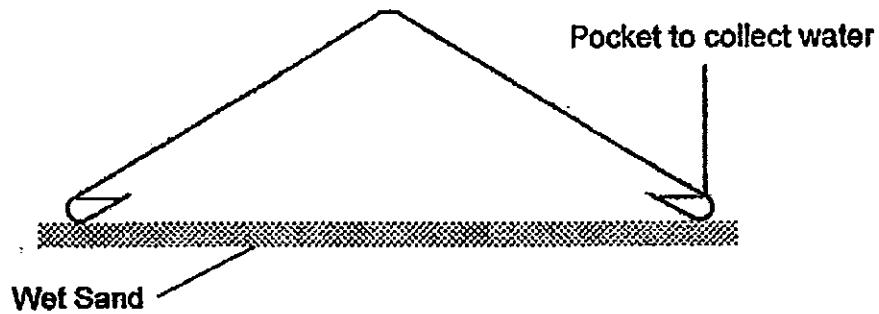

- a) Explain how the water is collected. [2]

- b) It is observed that on a cool and cloudy day, the amount of water collected is much lower. Give a reason for this observation. [1]

Score	3
-------	---

43. Four objects are hung from the ceiling as shown below.

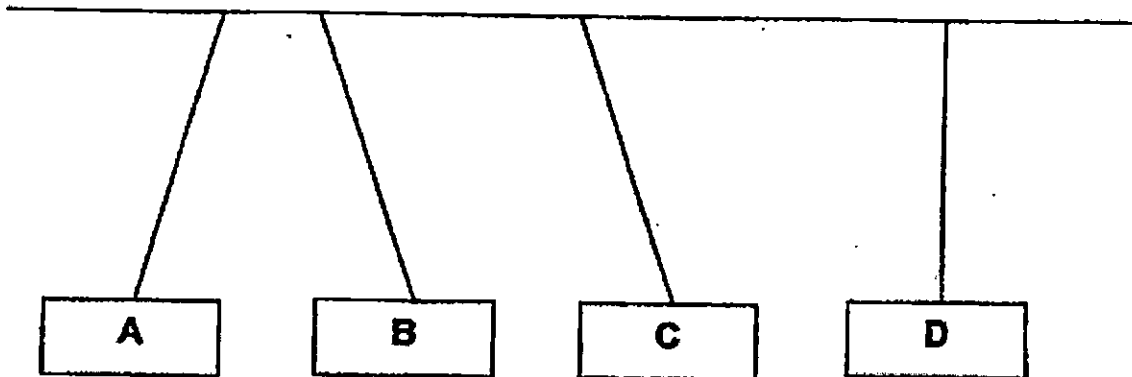

a) Which of the objects are definitely magnets? Explain your answer.

[2]

b) For objects A, B and C, what will happen if Object D is removed? Explain your answer.

[2]

Score	4
-------	---

44. Flora was able to pack a sponge into a container.

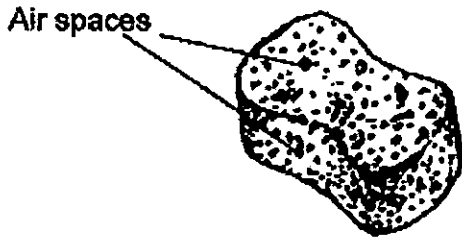

Volume of sponge: 15cm^3

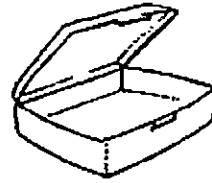

Volume of container: 10cm^3

a) Explain why Flora was successful in doing so?

[1]

Flora wants to transfer a full packet of orange juice into a cup.

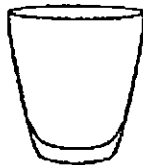

Volume: 100ml

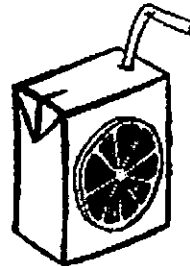

Volume of juice: 120ml

b) Will Flora be successful in doing so? Explain your answer.

[1]

End of paper

Score	2
-------	---



EXAM PAPER 2015

SCHOOL : NAN HUA

SUBJECT : P5 SCIENCE

TERM : SA2

Q1	Q2	Q3	Q4	Q5	Q6	Q7	Q8	Q9	Q10
2	1	1	1	1	3	4	2	3	2
Q11	Q12	Q13	Q14	Q15	Q16	Q17	Q18	Q19	Q20
2	2	4	2	3	4	1	3	4	1
Q21	Q22	Q23	Q24	Q25	Q26	Q27	Q28	Q29	Q30
2	2	3	4	3	4	1	4	3	3

31)a)Seed dispersal. b)Germination.

32)Country Q. There is a lower percentage of humidity in Country Q than Country P, so rate of evaporation is higher in a place of lower humidity.

33)i)No ii)No iii)Yes iv)No

34)

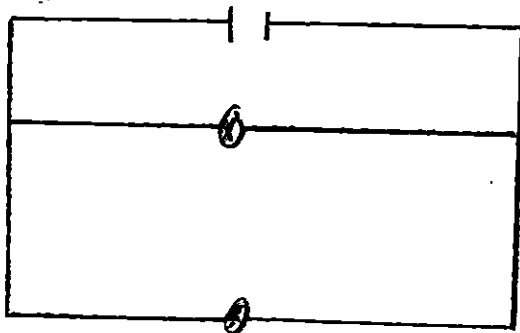

35)a)0°C 。

b)i)Plastic ii)Metal

c)Metal is better conductor of heat than plastic C so the ice in it gained heat faster.

36)a)D.

b)F and G inherited their single eyelids from E or from A to D to them.

37)a)The cell has chloroplast to trap light to make food, thus the cell moves towards light.

b)Oxygen and Food.

c)No. The nucleus controls the movements in the cell without it the tail cannot move.

38)a)A and B.

b)To find out whether different lengths of material affect the amount of electricity that passes through.

c)The meter can give accurate readings on the amount of electrical current passing through the circuit.

39)a)i)J.

ii)

39)b)i)B. ii)Wood.

40)a)The plants in sections A (red light)and C (blue light)produced oxygen but the plant in section B (green light)did not produce any oxygen.

b)Red and Blue light.

c)To ensure the results are reliable.

41)a)The amount of sugar produced by the plant increased when the light intensity increased from) lux to 90 lux. However, above 90 lux,the amount of sugar produced remained the same.

b)Z. It can produce more sugar at a low intensity although not highest at the end.

c)i)70mg ii)65mg

42)a)The water from the wet ground evaporated into water vapour. The water vapour then condenses into water droplets on the cooler surface of the cone leaking into the pocket as clean drinking water.

b)Rate of evaporation is lower when the surrounding temperature is lower.

43)a)A, B, C. Magnets repel and since A repels B and B repels C. The three object are definitely magnets.

b)The objects will stay the same. D is not a magnet nor a magnetic material as it does not attract or repel the magnets.

44)a)The were air spaces in the sponge to compress to be able to put the sponge in to the container.

b)No. Liquids cannot be compressed thus 20ml of juice will not be able to enter the cup.

3
END

