



Anglo-Chinese School (Primary)

P5 SCIENCE 2007

END-OF-YEAR EXAMINATION

BOOKLET A

Name: _____ () Class: Primary 5 ____

Date: 1 November 2007

Duration of paper: 1h 45 min

Parent's/Guardian's signature

**THIS BOOKLET CONTAINS 22 PAGES.
DO NOT OPEN THIS BOOKLET UNTIL YOU ARE TOLD TO DO SO.
FOLLOW ALL INSTRUCTIONS CAREFULLY.**

114

PART I

For each of the following questions from 1 to 30, four options are given. One of them is the correct answer. Make your choice (1, 2, 3 or 4). Shade the correct oval (1, 2, 3 or 4) on the Optical Answer Sheet.

(30 x 2 marks)

- 1 Benny was asked by his Science teacher to compare the life cycles of a cockroach and a butterfly. He presented the following statements in his assignment:
- A Both the cockroach and the butterfly lay eggs.
 - B Both the cockroach and the butterfly look after their young.
 - C Both the cockroach and the butterfly have wings in the adult stage.
 - D The cockroach has a 4-stage life cycle but the butterfly has a 3-stage life cycle.

Which of Benny's statements were correct?

- (1) A and B only
 - (2) A and C only
 - (3) A and D only
 - (4) C and D only
- 2 Each of the body systems, A, B, C and D below, contains one item which has been classified wrongly.

Body system A	Body system B	Body system C	Body system D
gullet	heart ...	biceps	nose
lung	skull	elbow joint	stomach
small intestine	rib cage	triceps	windpipe

Which one of the following shows the correct list of wrongly classified items?

- (1) lung, heart, elbow joint, stomach
 - (2) lung, skull, elbow joint, windpipe
 - (3) small intestine, heart, elbow joint, windpipe
 - (4) small intestine, skull, triceps, stomach
- 116

- 3 The diagram below shows the cross-section of a plant's stem. Tubes X shown below are used for transporting certain materials from one part of the plant to another. They form one part of the plant's transport system.

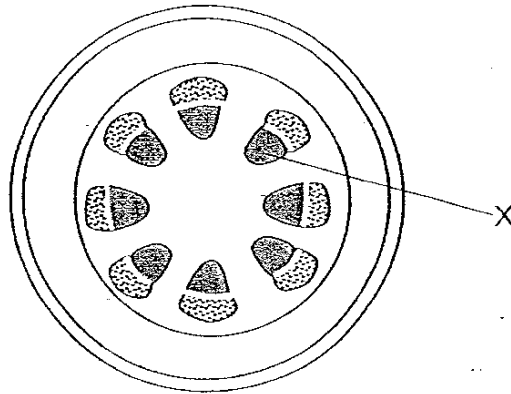

Compare the plant's transport system formed by tubes X to a public bus transport system. Choose the one set of answers below that show the correct comparison between the plant's transport system and the public bus transport system.

	Boarding point	Bus	Passengers
(1)	Roots	Food	Food
(2)	Roots	Water	Minerals
(3)	Leaves	Water	Food
(4)	Leaves	Water	Minerals

- 4 In the human body's circulatory system, there are 3 types of blood vessels:

- A Thin-walled blood vessels (Veins)
- B Thick-walled blood vessels (Arteries)
- C Very thin-walled blood vessels (Capillaries)

Which of the following shows the correct flow of blood from the heart to the other body organs?

- (1) A → C
- (2) B → C
- (3) C → A
- (4) C → B

- 5 The diagram below shows the drawing of an animal cell done by a student during his Science class. The labelling of the cell parts is not completely correct.

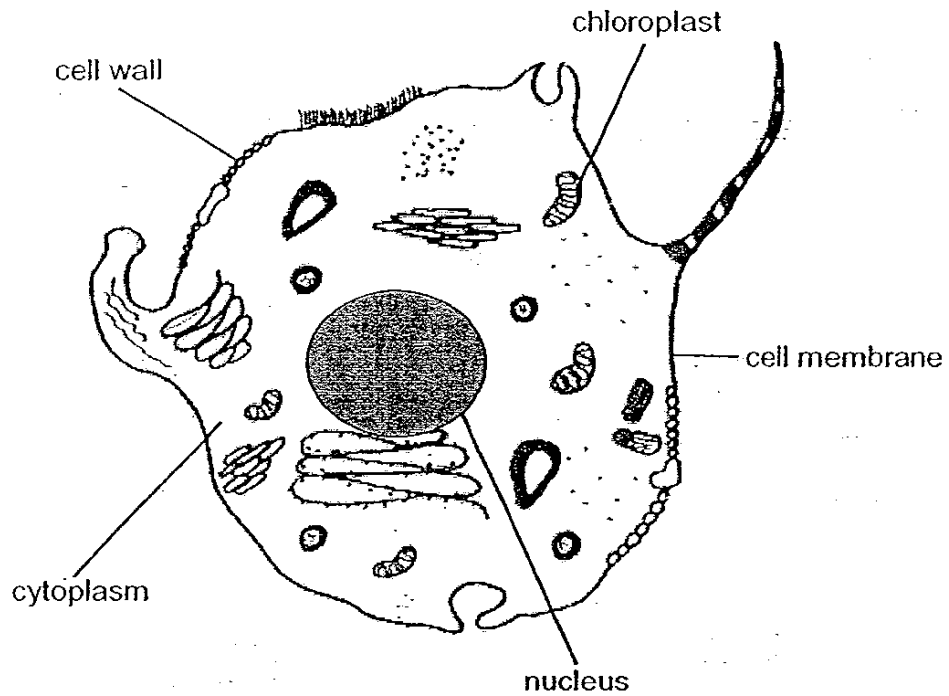

How many cell parts were labelled wrongly by the student?

- (1) 1
- (2) 2
- (3) 3
- (4) 4

- 6 Claire's Science teacher told her to write down some characteristics that she inherited from her parents.

This is what she wrote in her activity book:

<p>Characteristics inherited from Father:</p> <p>a) Black hair b) Brown eyes c) Short fingernails d) Detached earlobes</p>
--

<p>Characteristics inherited from Mother:</p> <p>a) Long hair b) Sharp nose c) Neat handwriting</p>

How many characteristics written down by Claire were correctly recorded as being inherited from her parents?

- (1) 4
(2) 5
(3) 6
(4) 7

- 7 For the cherry tree, both the male and female parts can be found on a single flower. An investigation was carried out on 4 similar cherry flowers growing on the same tree to find out whether a fruit can be produced when certain parts of a flower are removed. The table below shows which parts have been removed from the 4 flowers.

Cherry Flower	A	B	C	D
Change(s) made				
Male parts removed	✓			✓
Female parts removed		✓		
Petals removed			✓	✓

From the information from the table, which of the cherry flowers are still able to produce a fruit?

- (1) C only
(2) A and C only
(3) B and D only
(4) A, C and D only

8 Children inherit traits such as hair colour from their parents. Study the family tree below.

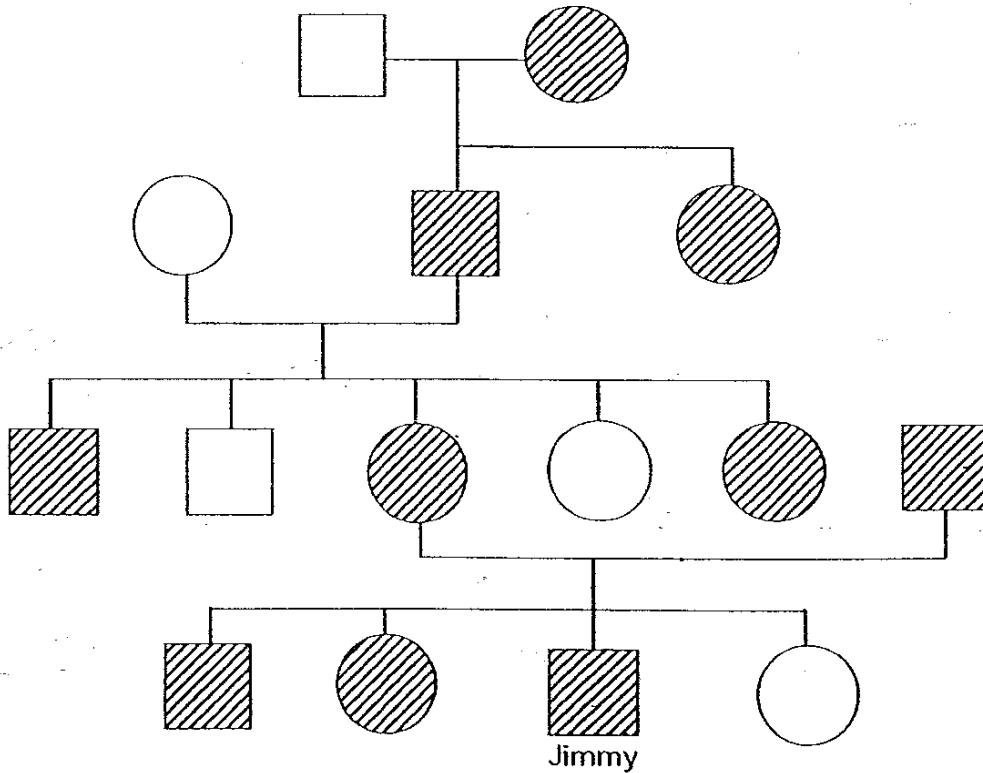
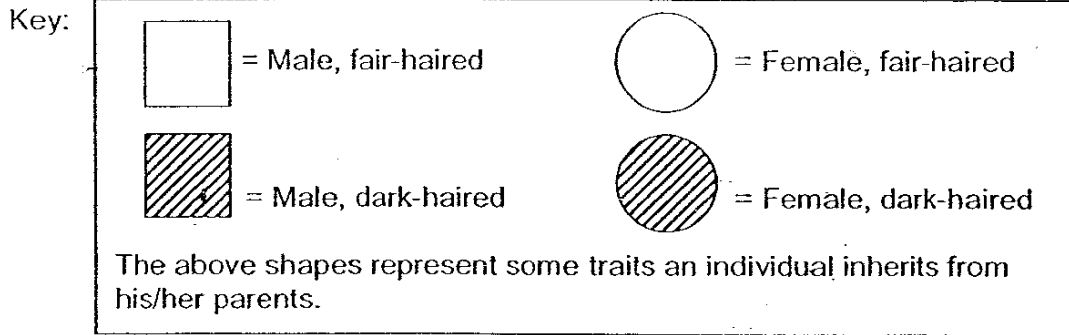

What is the total number of Jimmy's aunt(s) and uncle(s) who are dark-haired?

- (1) 1
- (2) 2
- (3) 3
- (4) 4

9 Study the four groups (A, B, C, D) below carefully.

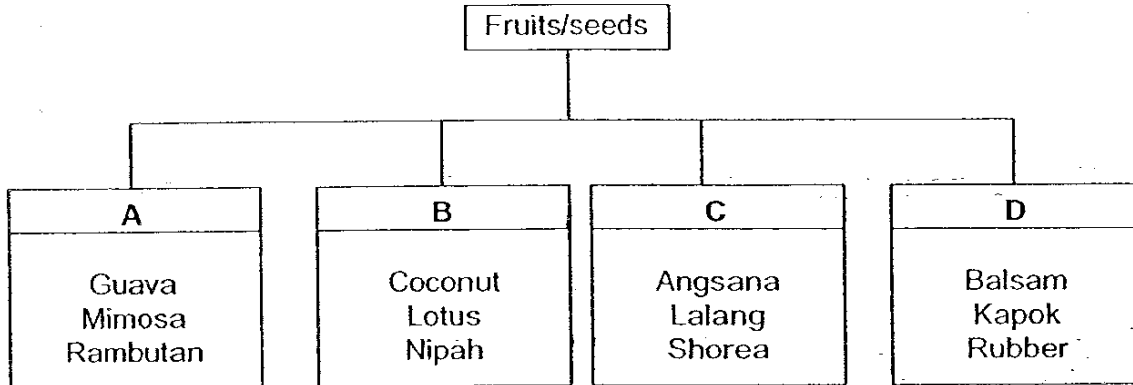

Which one of the following correctly identifies how the fruits/seeds are dispersed?

	A	B	C	D
(1)	By animals	By water	By splitting	By wind
(2)	By animals	By wind	By water	By splitting
(3)	By animals	By splitting	By wind	By water
(4)	By animals	By water	By wind	By splitting

10 Study the flow chart below.

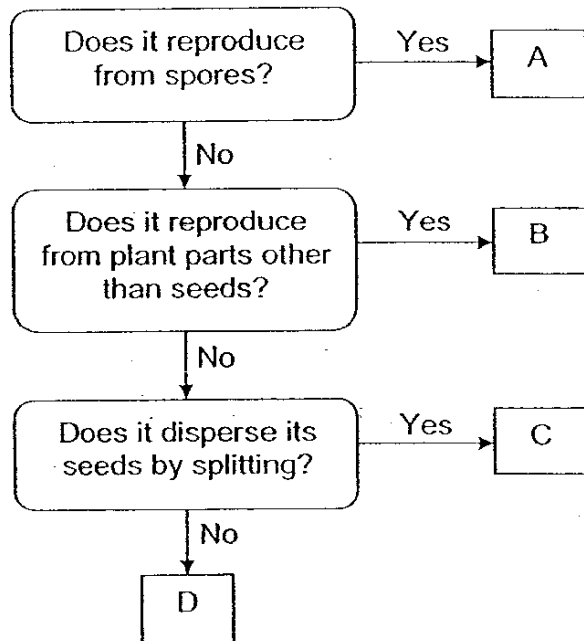

Which one of the following identifies A, B, C and D correctly?

	A	B	C	D
(1)	Fern	Apple	African Tulip	African Violet
(2)	Fern	Pineapple	African Violet	African Tulip
(3)	Moss	Banana	African Tulip	African Violet
(4)	Moss	Pineapple	African Violet	African Tulip

122

Use the information below to answer questions 11 and 12.

Eddie wants to find out whether rats give out water vapour during respiration. He sets up his experiment as shown below. His Science teacher told him that the original white crystals in test tubes X and Y will turn blue if water vapour is present. The valve stops air in the tank from flowing backwards into test tube X.

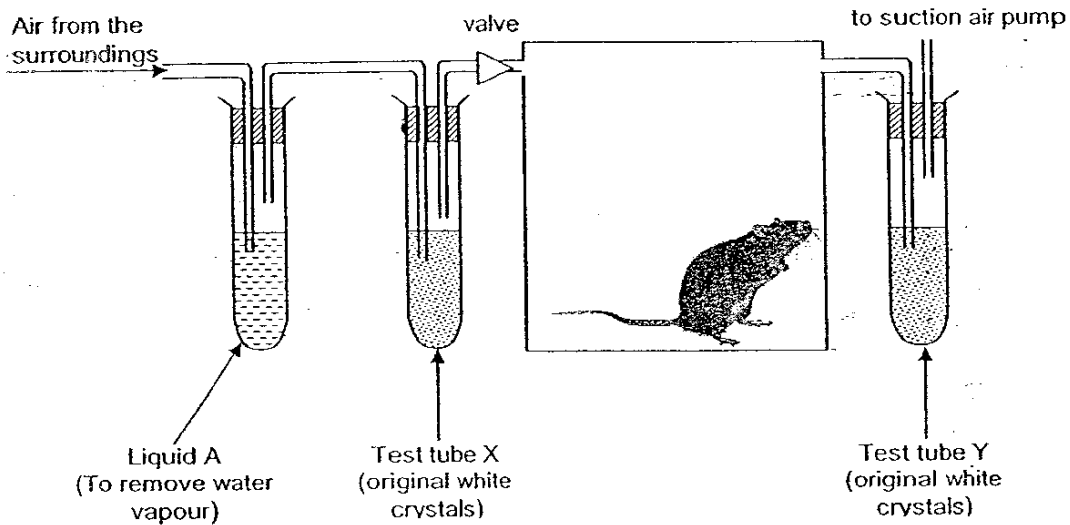

11 What is the purpose of test tube X in the experiment?

- A To find out if the rat gives out water vapour
- B To ensure that the rat gets enough water vapour
- C To check if the air entering the tank contains water vapour

- (1) A only
- (2) C only
- (3) A and B only
- (4) B and C only

12 Eddie observed the colour(s) of the crystals in the test tubes X and Y at the end of the experiment. He concluded from his experiment that the rat gave out water vapour during respiration. What should the colour of the crystals be for each test tube at the end of the experiment in order for him to have made that conclusion?

	Test tube X	Test tube Y
(1)	Blue	Blue
(2)	Blue	White
(3)	White	Blue
(4)	White	White

{2}

- 13 Four pupils (Amy, Billy, Celia and Danny) were asked to complete a table about photosynthesis and respiration. Their responses were shown below. A tick (✓) indicates a "Yes".

Amy's table		Takes place in the day	Takes place at night
	Photosynthesis	✓	✓
Respiration	✓	✓	

Billy's table		Takes place in the day	Takes place at night
	Photosynthesis	✓	
Respiration	✓	✓	

Celia's table		Takes place in the day	Takes place at night
	Photosynthesis	✓	
Respiration	✓		

Danny's table		Takes place in the day	Takes place at night
	Photosynthesis	✓	
Respiration		✓	

Which pupil completed the table correctly?

- (1) Amy
- (2) Billy
- (3) Celia
- (4) Danny

14 Tom sketched 4 graphs each to show the changing amount of carbon dioxide in the air around an angšana tree measured over an 18-hour period.

Which one of the following graphs is most likely to be accurate?

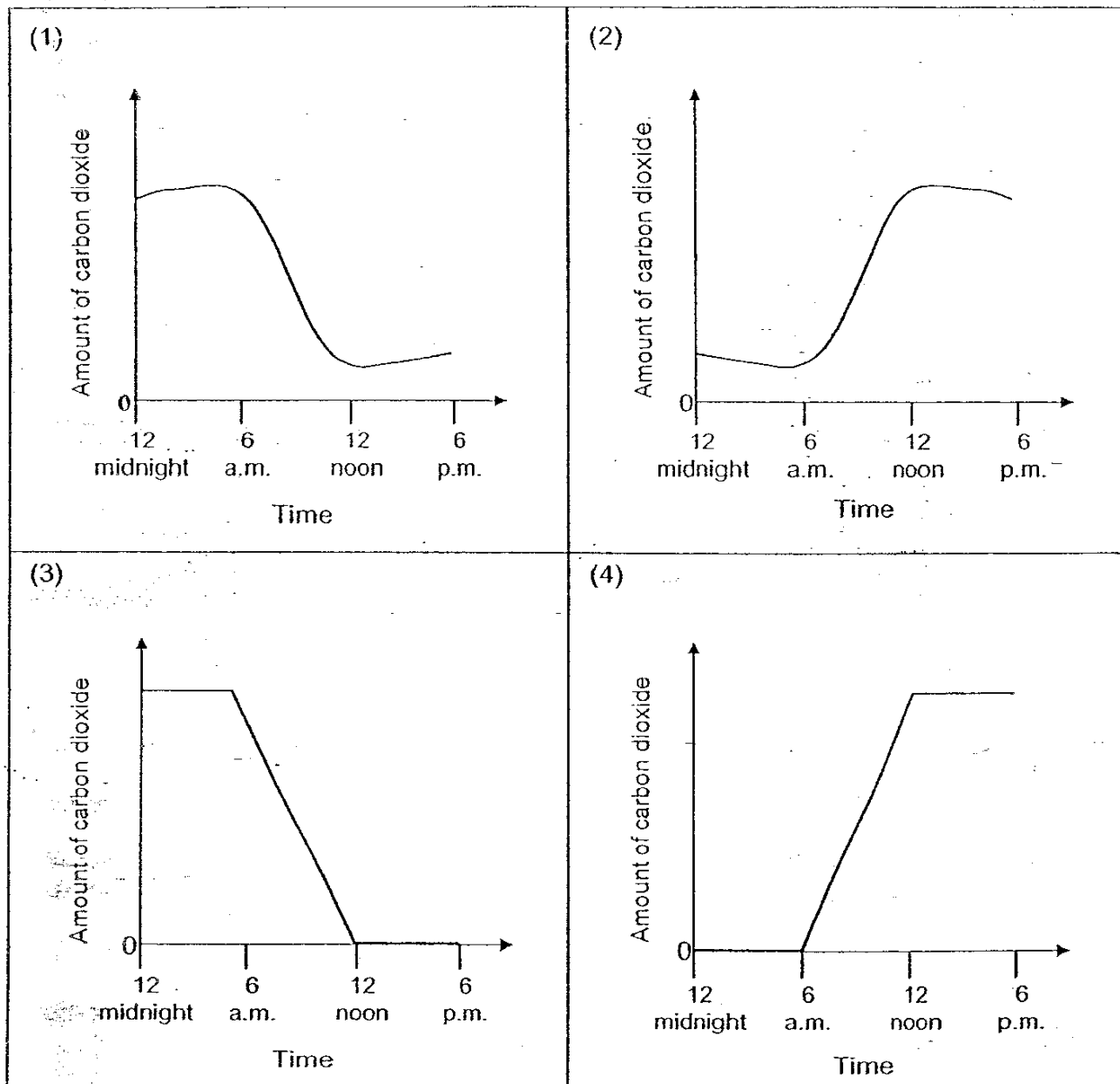

(1)

- 15 Paul set up an experiment over a period of time as shown in the diagram below. At the end of the experiment, it was observed that some of the potted plants grew healthily but not others.

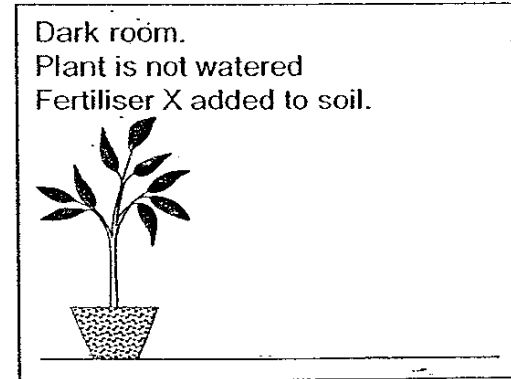
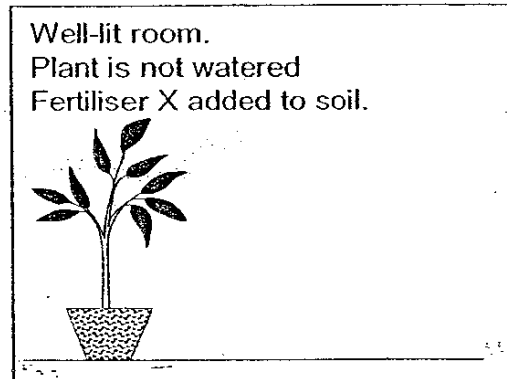
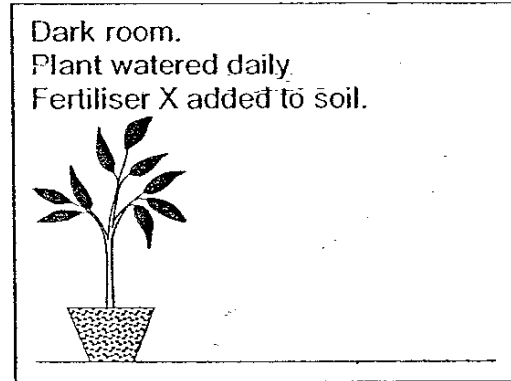
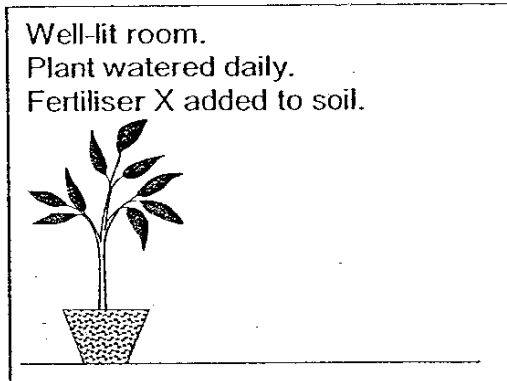

What was the likely aim of Paul's experiment?

- (1) To find out whether potted plants need light to grow healthily.
- (2) To find out whether potted plants need light and water to grow healthily.
- (3) To find out whether potted plants need light and fertiliser to grow healthily.
- (4) To find out whether potted plants need light, fertiliser and water to grow healthily.

- 16 A, B, C and D are magnets hanging from strings of two different lengths as shown in the diagram below.
A plastic tray of steel pins is placed below the magnets and different numbers of pins are attracted to the magnets.

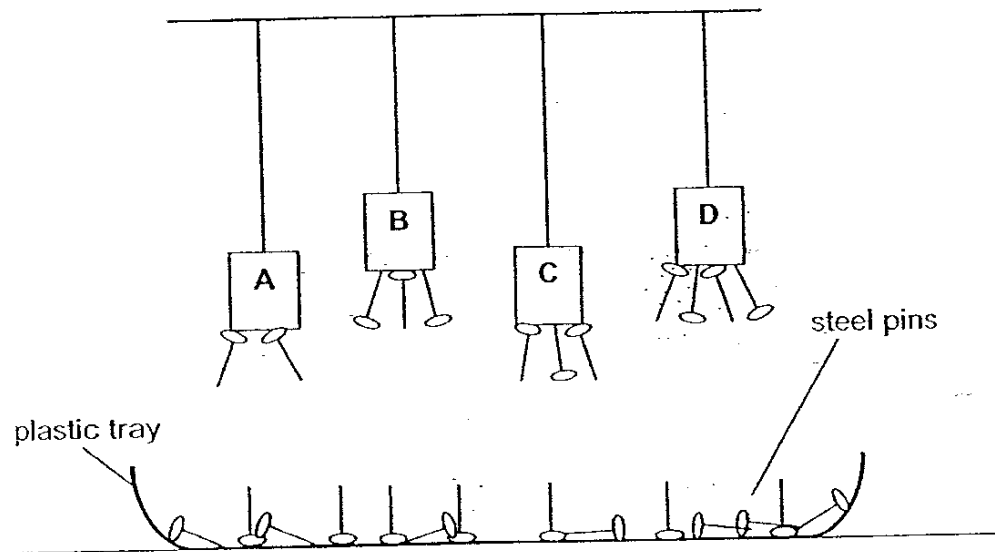

Based on the diagram above, arrange the magnets A, B, C and D in descending order of their strength.

- (1) ABCD
- (2) ACBD
- (3) DBCA
- (4) DCBA

127

- 17 Ronald performed an experiment using the setup below. Lines P, Q, R, S, T and U are 15cm apart and parallel to one another. The torchlight shown below is placed along line Q.

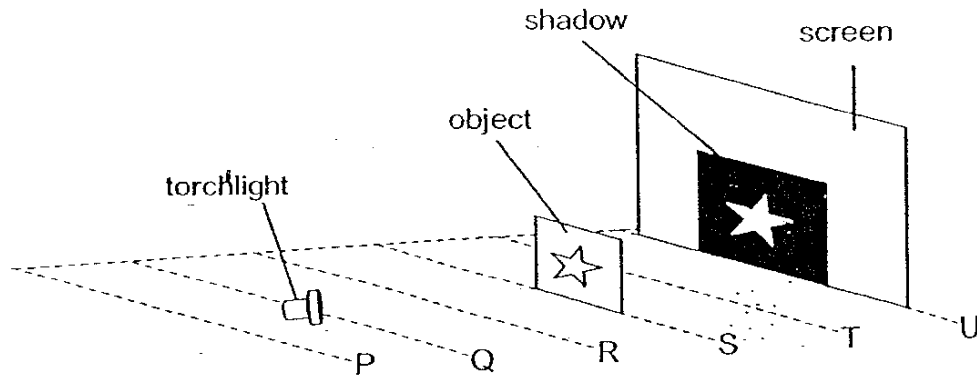

Without moving the screen, how would Ronald be able to create a smaller "star" on the screen?

- (1) Move the object nearer to the screen.
- (2) Move the torchlight nearer to the object.
- (3) Move the object nearer to the torchlight.
- (4) Move the object further away from the screen.

- 18 The graph below shows the rate of expansion of different metals when heated under identical condition.

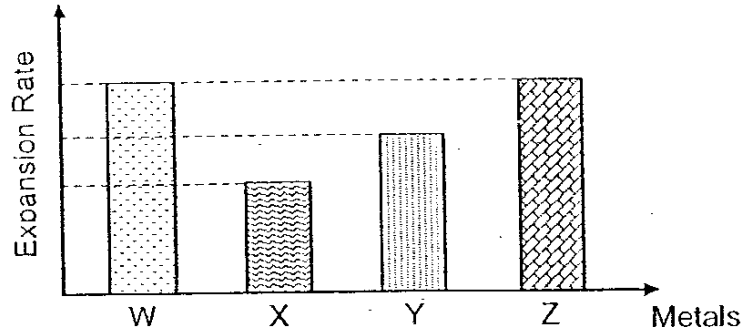

The diagram below shows 3 sets of rings P, Q and R. Each set of rings comprises of 2 rings made from different metals (W, X, Y and Z). All the inner rings initially fit exactly into the outer rings.

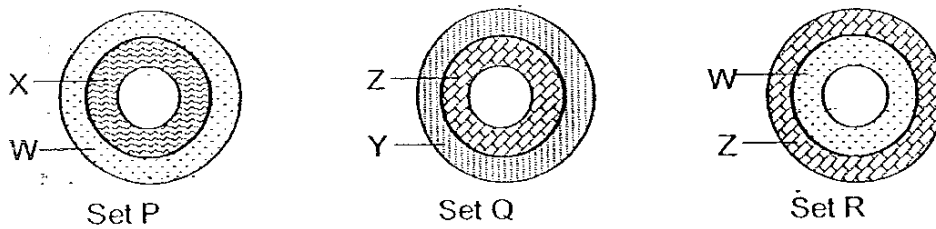

The sets of rings (P, Q and R) are heated evenly over a period of time. Which one of the following statements about the sets of rings is correct?

- (1) Only the rings in set R fell apart.
- (2) Only the rings in set Q became tighter.
- (3) The rings in set P became tighter while those in set Q fell apart.
- (4) The rings in sets P and R fell apart while those in set Q became tighter.

129

19 Which of the following statements are true of the Earth and the Moon?

- A The Moon can be seen from the Earth every night.
- B Both the Moon and the Earth rotate about their own axes.
- C The phases of the Moon are caused by the regular movement of the Moon around the Earth.

- (1) A and B only
- (2) A and C only
- (3) B and C only
- (4) A, B and C

20 Julian was asked to classify some actions according to the forces involved. Which one of the following classification is correct?

	Push only	Pull only	Pull & Push
(1)	rubber fruit exploding	hoisting a flag	wringing a wet cloth to dryness
(2)	pumping air into a ball	wringing a wet cloth to dryness	hoisting a flag
(3)	tearing a piece of paper	tugging a luggage	rubber fruit exploding
(4)	tugging a luggage	tearing a piece of paper	pumping air into a ball

21 The diagram below shows 3 objects X, Y and Z being used to balance a load of 250g.

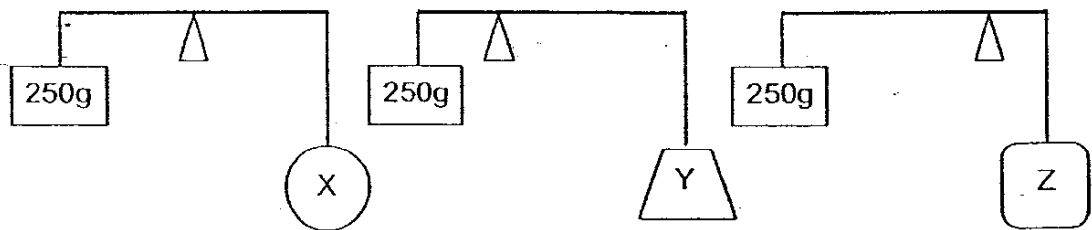

Arrange objects X, Y and Z in ascending order of their weight.

- (1) XYZ
- (2) YXZ
- (3) ZYX
- (4) ZXY

22 The diagram below shows 4 different pulley systems P, Q, R and S.

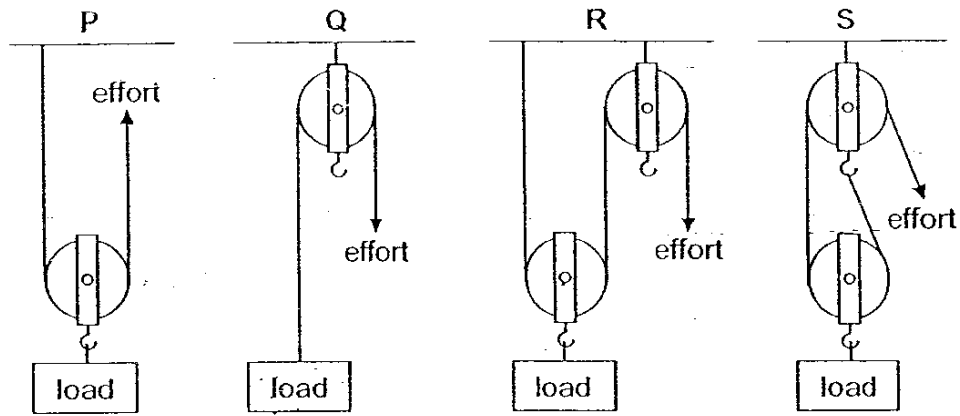

In which of the above system(s) would the distance moved by the effort be greater than the distance moved by the load?

- (1) P and Q only
- (2) P and R only
- (3) R and S only
- (4) P, R and S only

23 Which one of the sets of wheel and axle below helps change the direction of force as well as enables a smaller force to overcome a heavier load?

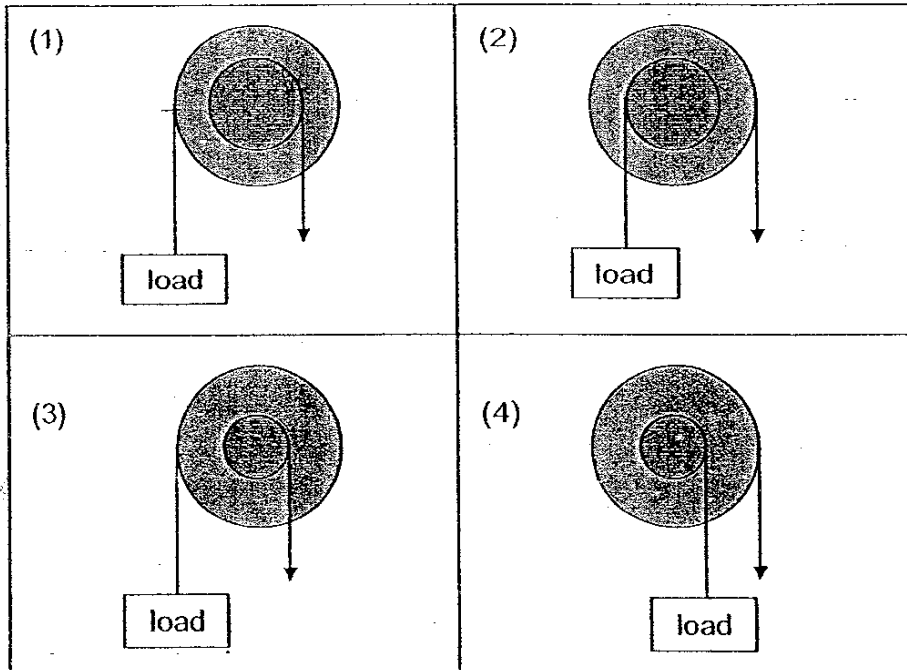

- 24 Samuel wanted to find out how the angle of inclination affects the force needed to pull a load of 300g up a ramp. He began by pulling the load along the ramp which was placed horizontally on the ground. He then increased the angle of inclination gradually by supporting it against a wooden board. When the ramp was perpendicular to the ground, the load was still in contact with the ramp.

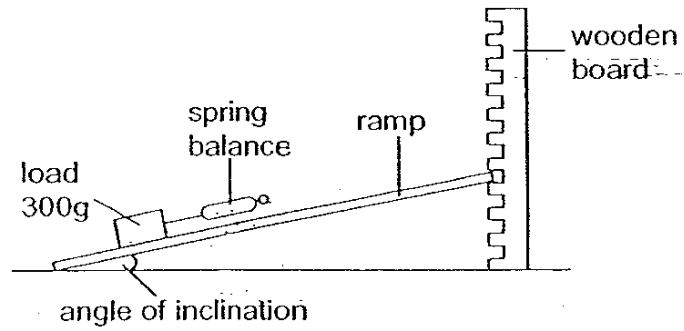

Which one of the following graphs most likely shows the relationship between the angle of inclination and the force needed to move the load?

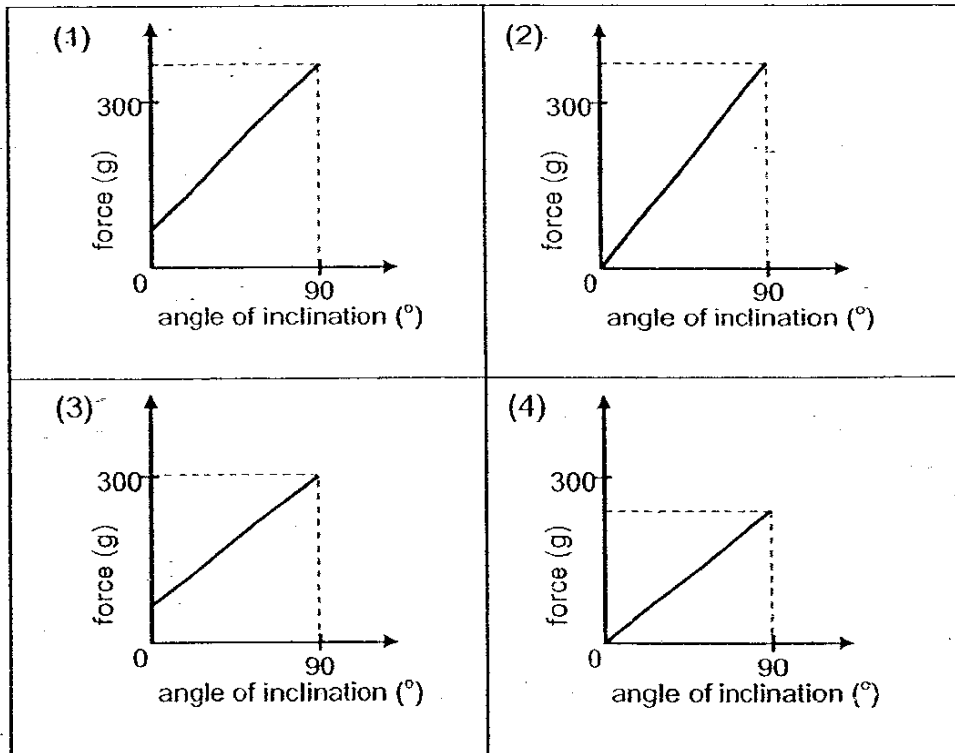

- 25 The wine bottle opener shown below is made up of a number of simple machines.

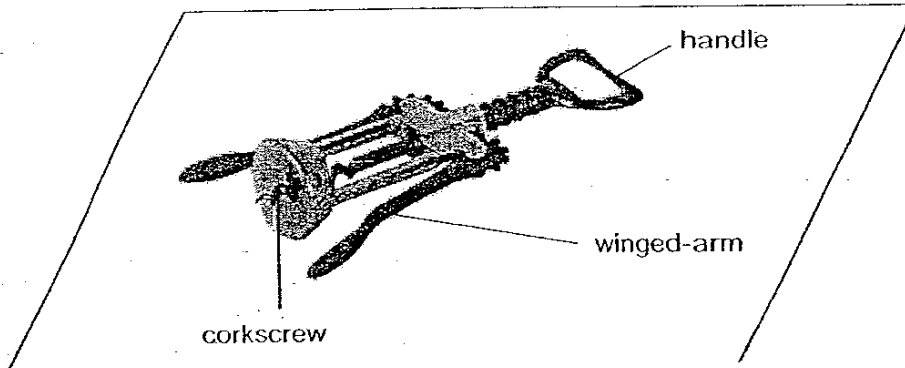

The diagrams below show the steps of using the wine bottle opener to remove the cork from the wine bottle:

<p>Step One Push the end of the corkscrew into the centre of the cork</p>	<p>Step Two Turn the handle clockwise until the corkscrew is well into the cork Note: As the corkscrew goes into the cork, the winged-arms will begin to rise.</p>	<p>Step Three Press the winged arms down to lift the cork out of the bottle</p>

What are the simple machines found in the wine opener?

- A lever
- B gears
- C inclined plane
- D wheel and axle

- (1) A and C only
- (2) B and D only
- (3) B, C and D only
- (4) A, B, C and D

- 26 A similar bulb is connected to a number of new 1.5V batteries as shown below. In which circuit will the bulb light up most brightly when the switches are closed?

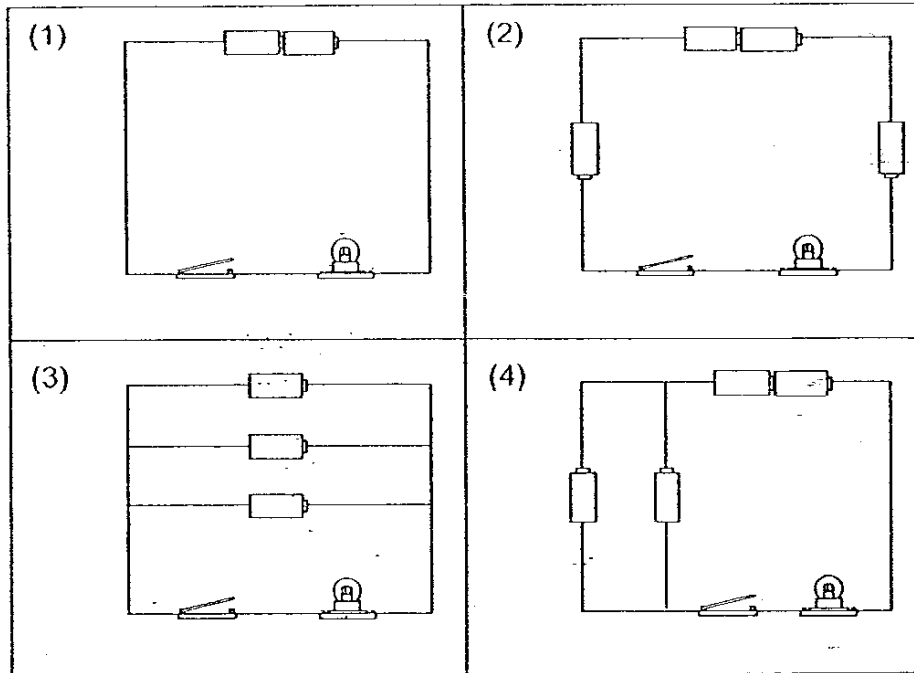

- 27 Study the circuit below.

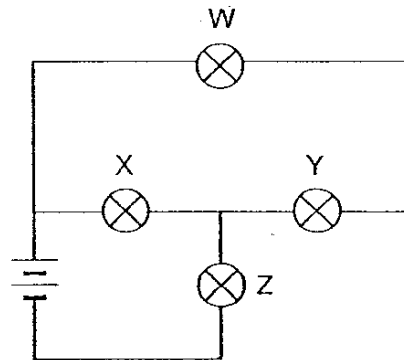

Which bulb(s) will remain lighted when bulb Y blows?

- (1) Z only
- (2) X and Z only
- (3) W, X and Z
- (4) None of the bulbs

- 28 The diagram below shows 3 bells (A, B and C) correctly connected in a circuit.

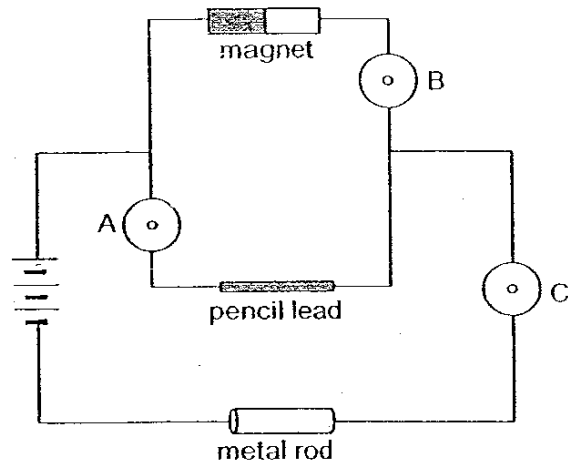

Which of these bells will ring?

- (1) A and B only
- (2) A and C only
- (3) B and C only
- (4) A, B and C

29 Wei Hao recorded the following results when he tested an electrical circuit.

Switch A	Switch B	Number of bulbs lighted
Off	Off	0
On	Off	1
Off	On	0
On	On	2

Which one of the following circuits will produce the results shown above?

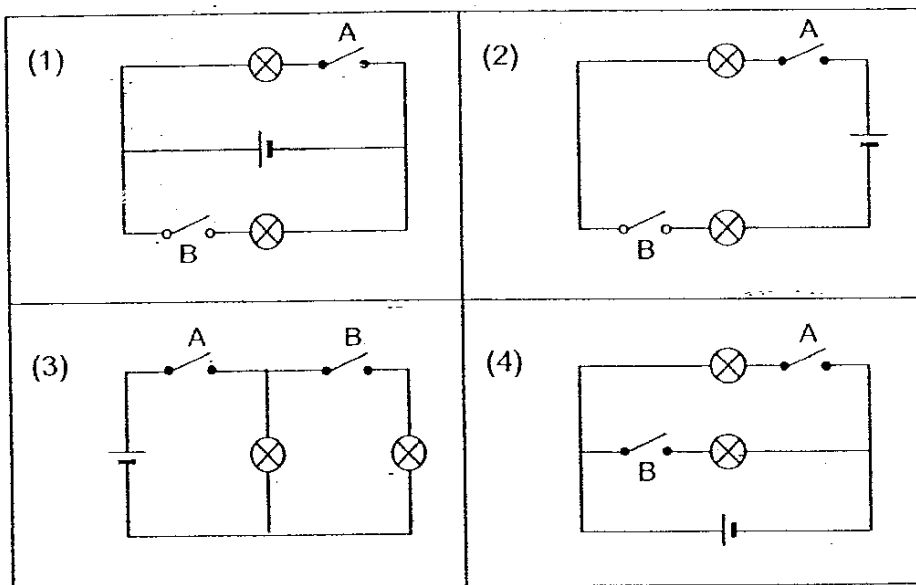

- 30 A circuit card is tested with a circuit tester. The results are given in the table below.

Clips tested	Does the bulb in the circuit tester light up?
A and D	No
B and C	Yes
C and E	Yes
D and E	No

Which one of the following most likely shows the circuit card being tested?

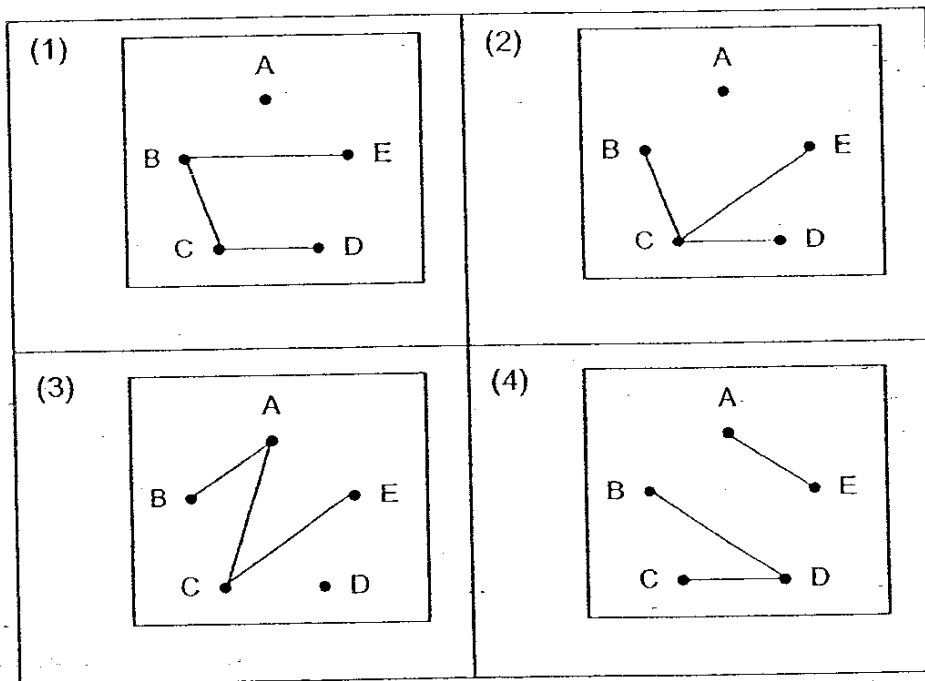

THE END

137



Anglo-Chinese School (Primary)

P5 SCIENCE 2007

END-OF-YEAR EXAMINATION

BOOKLET B

Name: _____ () Class: Primary 5 ____

Date: 1 November 2007

Duration of paper: 1h 45 min

	Maximum Marks	Marks Obtained
Section A / Booklet A	60	
Section B / Booklet B	40	
Total	100	

**THIS BOOKLET CONTAINS 15 PAGES.
DO NOT OPEN THIS BOOKLET UNTIL YOU ARE TOLD TO DO SO.
FOLLOW ALL INSTRUCTIONS CAREFULLY.**

PART II

For questions 31 to 46, write your answers in this booklet.

The number of marks available is shown in brackets [] at the end of each question or part question.

(40 marks)

- 31 Dengue fever is the most common mosquito-borne viral disease in the world. It is transmitted by the female *Aedes* mosquito. People living in HDB flats were advised to cover their bamboo pole holders (shown below) as a way to prevent the spread of dengue in Singapore.

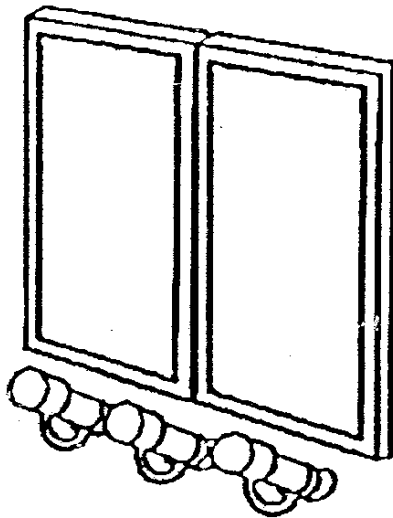

Covered bamboo pole holders

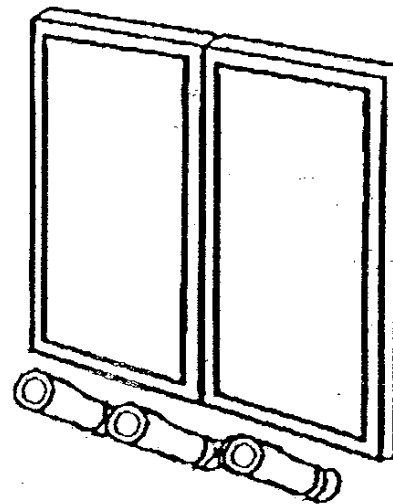

Uncovered bamboo pole holders

How does covering the bamboo pole holders when they are not in use help to prevent the spread of dengue fever? [2]

- 32 Debbie planted a seed in some soil and watered it each day. She observed its growth and recorded the lengths of its root and shoot. The following table shows the lengths of the shoots and roots she recorded.

Day	Part X (mm)	Part Y (mm)
1	0	0
2	0	0
3	0	2
4	0	4
5	2	6
6	5	9
7	8	11

- (a) Which part, X or ~~Y~~, is the root? Explain your answer. [2]

- (b) Debbie observed that the seedling did not have any green leaves. Where did it get its energy for growth? [1]

- 33 The graph below shows the amount of undigested food from the time food was consumed, as it passes through the human digestive system from organ A to E. Study the graph carefully and answer the questions below based on the data in the graph.

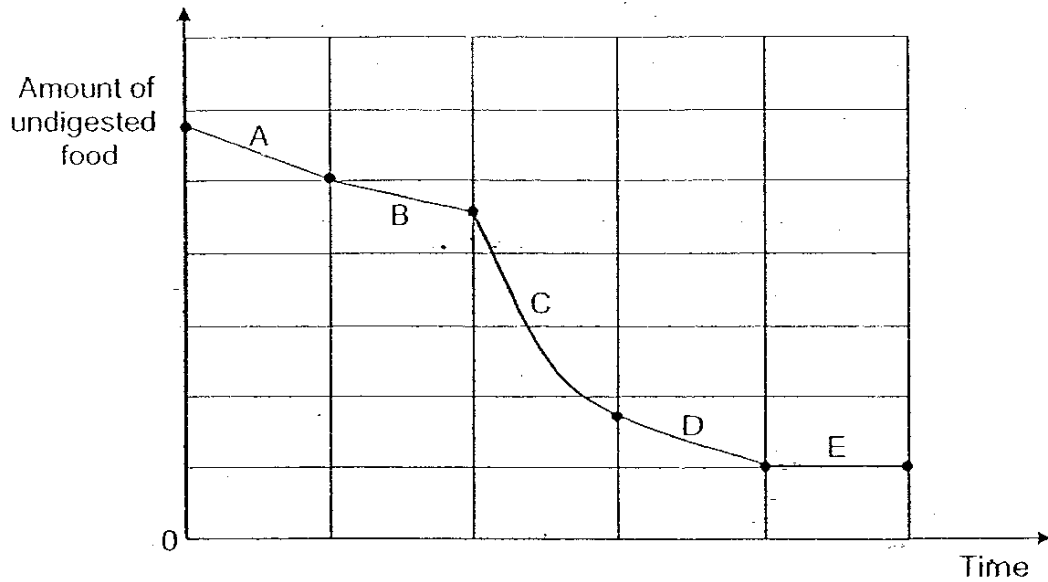

- (a) Based on the graph, in which of the organs A, B, C, D and E was there no digestion taking place? [1]
-
- (b) Name the organ(s) you mentioned in (a) above. [1]
-

34 David noticed that some plants needed more water than others. He wanted to find out if plants with thicker stems took in more water than plants with thinner stems. He carried out an experiment using celery stalks. The diagram below shows his experimental setup.

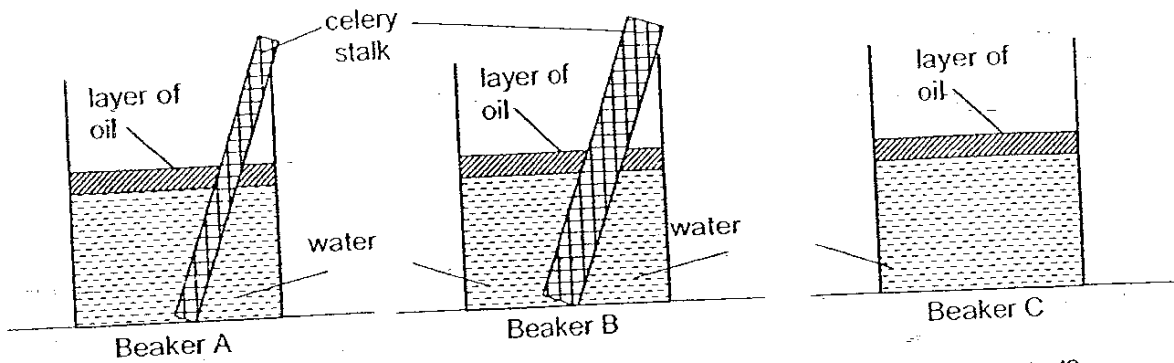

(a) David set up Beaker C as a control. What was the purpose of the control? [1]

(b) Why did David add a layer of oil to all the three setups? [1]

- 35 The seeds/fruits of plants X, Y and Z are dispersed using different methods. The following diagrams show the distribution of the 3 types of plants in 2005 and 2006 respectively.

In 2005

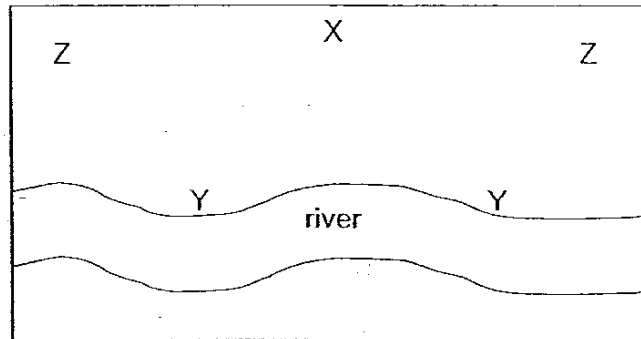

In 2006

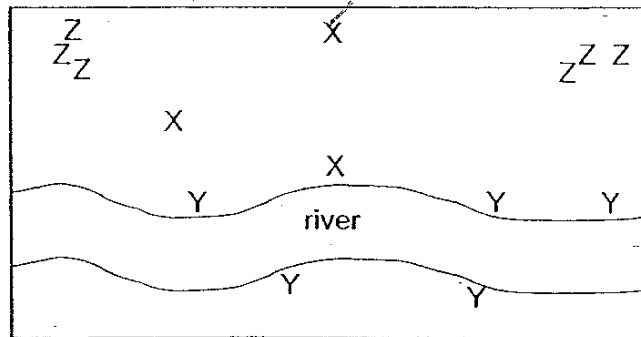

- (a) Which plant's seeds were most likely dispersed by splitting? [1]

- (b) Describe one likely characteristic of plant Y's fruits. [1]

36 Maggie placed a datalogger next to a plant to measure the temperature of the surroundings and the light received from the sun at five time intervals. Study the bar graphs below to answer the questions that follow.

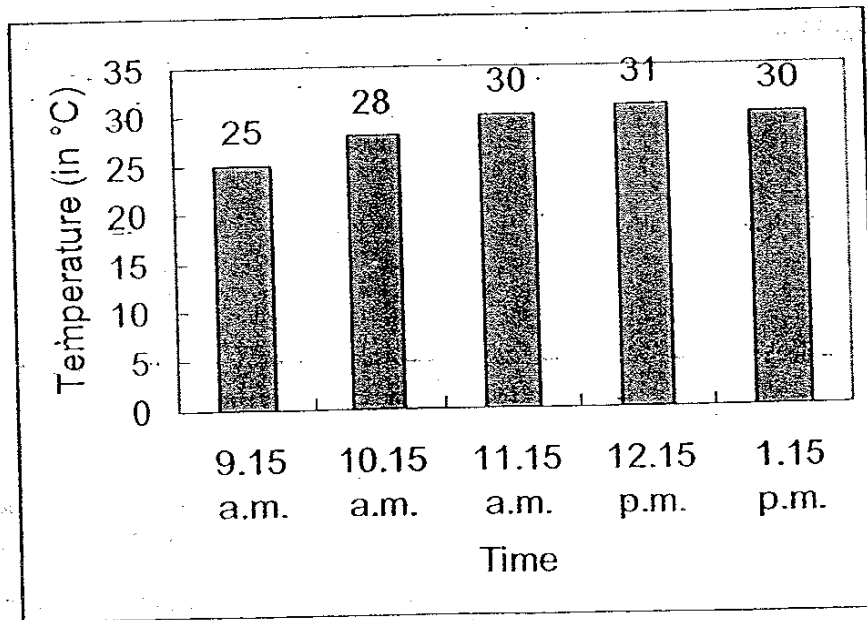
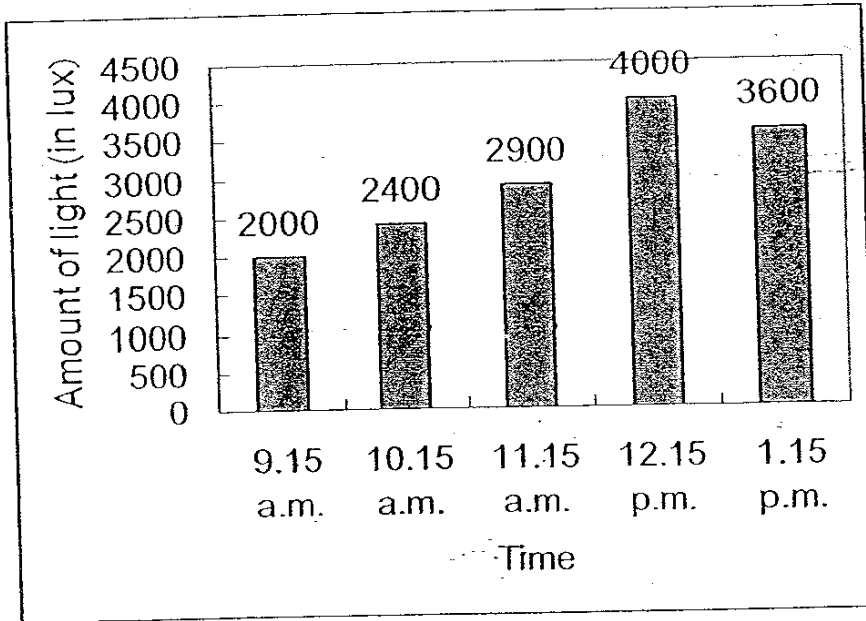

145

- (a) Based on the graphs drawn, at what time was the rate of photosynthesis most likely the greatest? [1]

- (b) Based on the graphs drawn, in what way is the temperature related to the amount of light received? [1]

- (c) What could be the amount of light received by the plant at 11.45 a.m.? [1]

- 37 The picture below is a drawing of a plant cell seen under a powerful microscope. The labels for the cell parts have not been written.

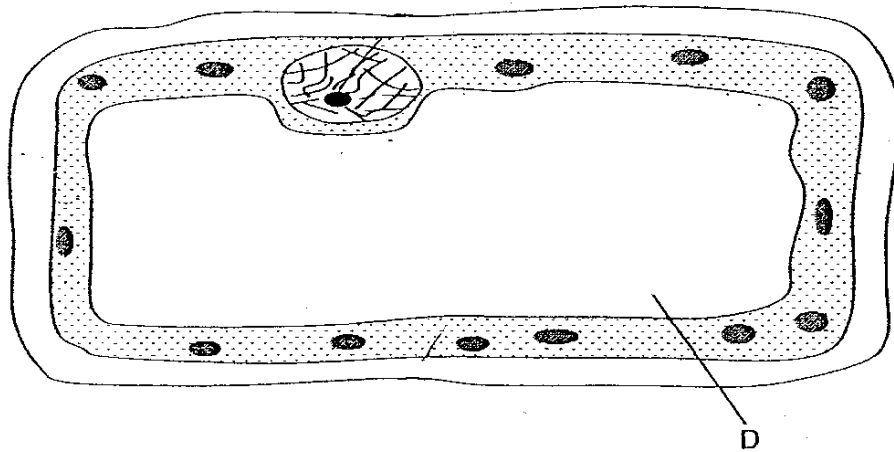

Draw 3 lines and use the letters A, B and C to label the cell parts described below clearly. An example (D: vacuole) has been drawn above.

- (a) A: the cell part which controls the activities of the cell [1]
- (b) B: the cell part which is partially permeable [1]
- (c) C: the cell part which supports the cell and gives it a regular shape [1]

38 Kate sets up an experiment using a table lamp and a small hydrilla plant placed in a beaker of water as shown below. The experiment was conducted in a dark room with the table lamp being the only source of light.

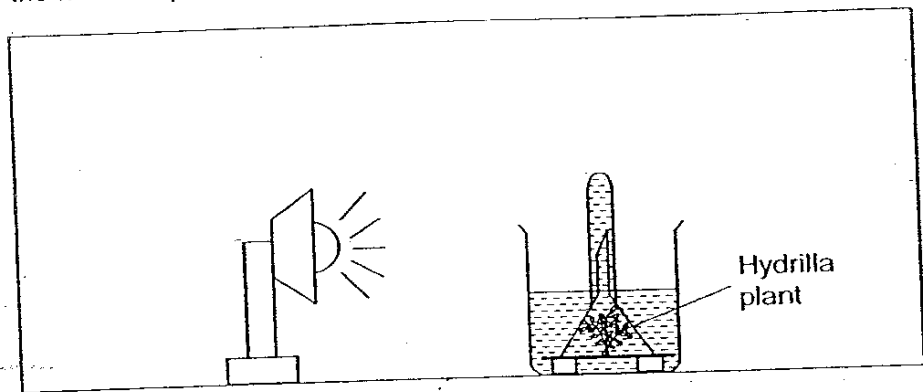

After the experiment, she drew a graph as shown below :

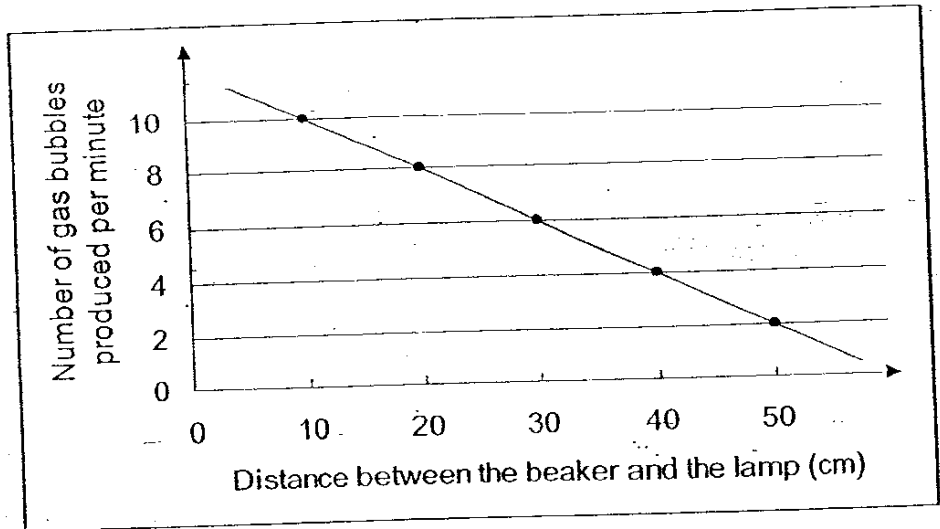

(a) What was the aim of Kate's experiment? [1]

(b) What conclusion can Kate make from the experiment? [2]

147

- 39 Melvin wanted to compare the strength of the 4 magnets A, B, C and D shown below.

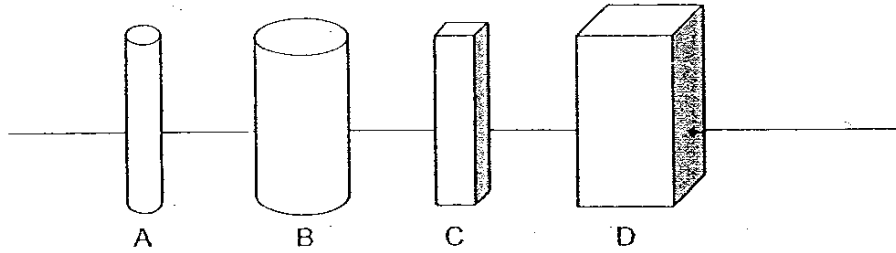

He placed each of the magnets above a pile of pins and recorded the number of pins attracted by each magnet :

Magnet	Distance between magnet and pins (cm)	Number of pins attracted
A	3	12
B	4	12
C	3	15
D	5	10

- (a) Melvin's experiment was not a fair test. What should he do to ensure a fair test? [1]

- (b) State 2 valid conclusions about the strengths of magnets A, B and C that Melvin could draw based on his experimental results shown above. [2]

(i) _____

(ii) _____

40

Rashid used a light sensor to determine the amount of light that was able to pass through ³ similar cards of different materials in his experiment.

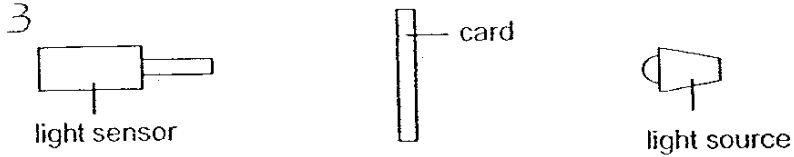

The light sensor reads from a scale of 0 to 10; and a high reading indicates that a greater amount of light has been detected.

He recorded the results in the table below.

Card	Reading on light sensor
P	0
Q	5
R	10

Rashid then cut the cards P, Q and R into a triangle, a circle and a square respectively. The cut shapes were glued together one on top of the other and held between the light source and the floor as shown below.

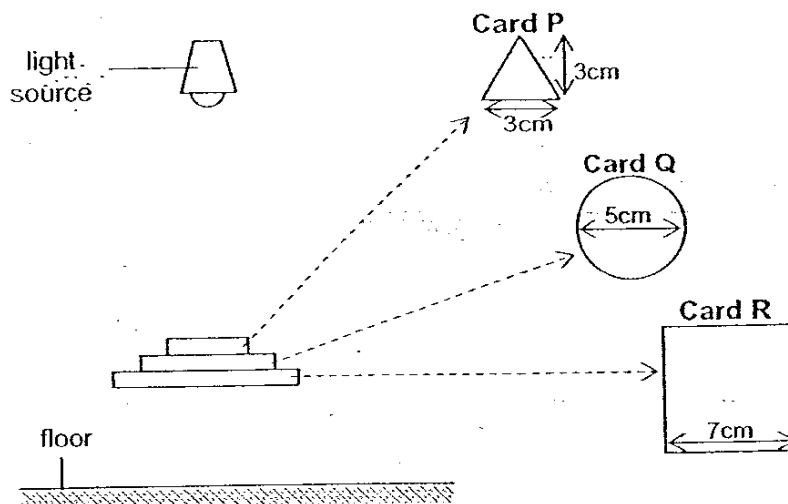

Shade the shadow that would be observed on the floor in the box below. The outlines of the cut shapes have been included as a guide.

[2]

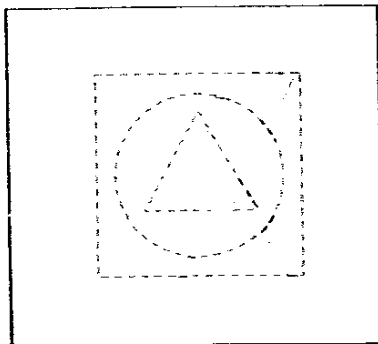

- 41) Substance W has a boiling point of 70°C and a melting point of 20°C . A sample of solid W was heated from 20°C to 70°C . It took 3 minutes for the solid to become totally liquid and another 7 minutes to start boiling. It was then continuously heated for another 5 minutes till the end of the experiment.

Draw a line graph to show how the temperature of the substance W changes for the first 15 minutes. [2]

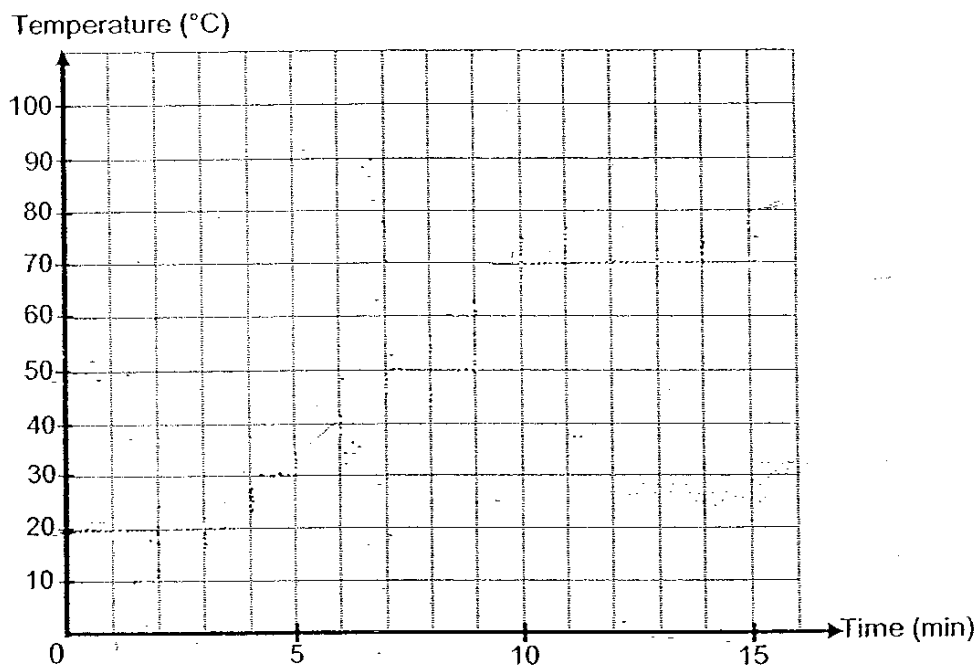

42 The following moon phase was observed from Earth on 12 February:



(a) In the diagram below, mark with an 'X' the correct position of the Moon which enable the above moon phase to be seen. [1]

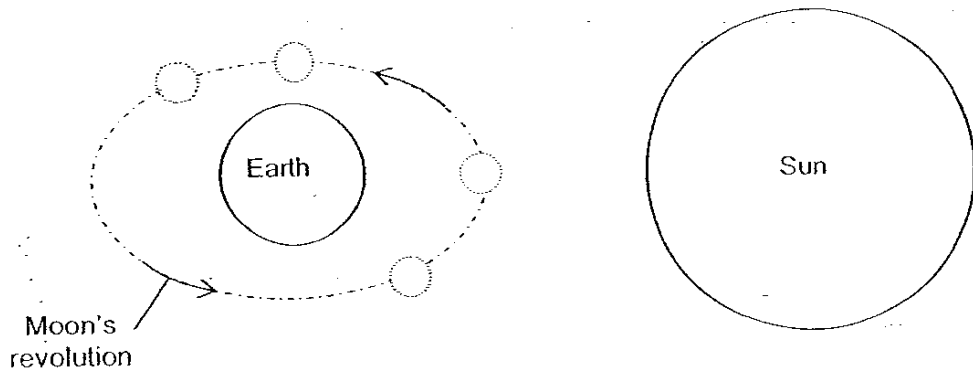

(b) In the boxes below, draw on the outlines provided to show the correct sequence of the shapes of the Moon observed from Earth on 4 February, 19 February and 26 February. [2]

4 February	19 February	26 February

(5)

43 Study the gear system below.

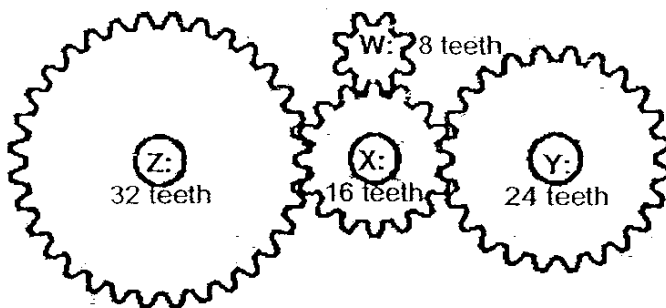

(a) Which gear(s) will rotate at half the speed of gear X? [1]

(b) If gear Z turns clockwise, which gear(s) will turn in an anti-clockwise direction? [1]

44 The diagram below shows a human arm lifting a load upwards.

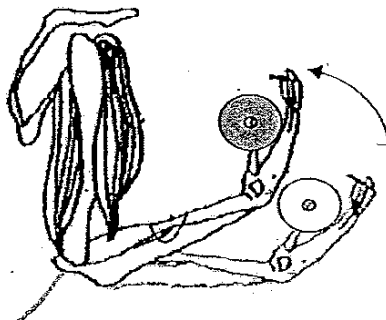

(a) Label the fulcrum and the effort in the diagram above. [1]

(b) How does the human arm help make work easier? [1]

- 45 Gabriel had three rods (P, Q and R) of different materials. He placed them at different positions as shown in the circuit shown below.

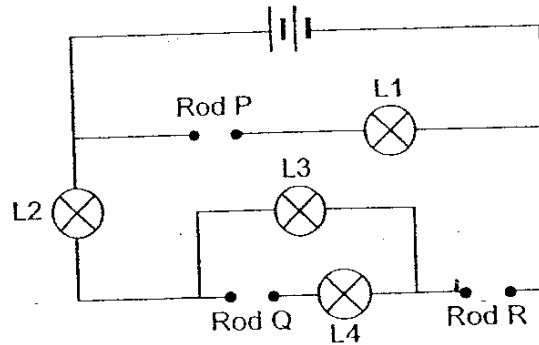

The results of the experiment were shown in the table below.

Did the bulb light up?			
L1	L2	L3	L4
yes	yes	yes	no

- (a) Based on the results above, what could you conclude about the properties of the materials for the rods P, Q and R? [1]

- (b) Complete the table below by filling in "Yes" or "No" to show the correct results when various different materials were used at the same time to make the rods P, Q and R. [2]



	Material of rods			Did the bulb light up?			
	P	Q	R	L1	L2	L3	L4
(i)	wooden rod	iron rod	silver rod				
(ii)	iron rod	silver rod	wooden rod				

46 Colin wanted to find out how the number of dry cells used in a circuit affects the brightness of a bulb. He was only given the following materials:

- two identical bulbs
- three identical dry cells
- some wires

He was also allowed to set up only two circuits for his experiment.

(a) Using the symbols provided in the key, draw the two circuit diagrams to show how he would carry out his experiment. [2]

Circuit Diagram	
<u>Set-up 1</u>	Key  bulb  dry cell  wire
<u>Set-up 2</u>	

(b) What could Colin conclude from the two set-ups drawn above? [1]

THE END

154

ACS Primary School

Primary 5 Science SA2 Exams (2007)

Answer Keys

SECTION A : (60 MARKS)

Qn no.	Ans
1	2
2	1
3	2
4	2
5	2
6	1
7	4
8	2
9	4
10	3

Qn no.	Ans
11	2
12	3
13	2
14	1
15	2
16	3
17	1
18	2
19	3
20	1

Qn no.	Ans
21	2
22	4
23	2
24	3
25	4
26	4
27	2
28	4
29	3
30	3

SECTION B (40 MARKS)

31. When it rains, water will enter the bamboo pole holders, then the water inside will be still. As mosquitoes lay eggs in stagnant water, we can prevent that by covering all bamboo pole holders when they are not in use.
- 32a Part Y. The roots have to grow deeply into the soil to get water and mineral salts for the seed.
- 32b It comes from the seed leaves that are covered with the seed coat.
- 33a E.
- 33b Large intestine.
- 34a To show that the decrease in volume of water is due to the plants taking in water.
- 34b To prevent evaporation of water so that he can have a fair result.
- 35a Plant Z.
- 35b It enables it to float on water.
- 36a 12.15pm
- 36b The more light received, the temperature increase.
- 36c 3500 lux

37

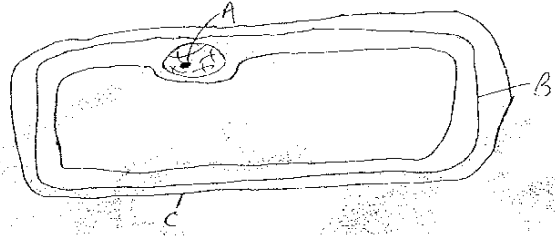

38a To find out if the distance between the beaker and the lamp affects the number of gas bubbles produced per minute.

38b The further the beaker from the lamp, the less gas bubbles produced by the plant.

39a He should use the same type of magnets.

39b (i) Magnet B is stronger than magnet A.

(ii) The strength of magnet C is stronger than A.

40.

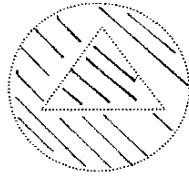

41.

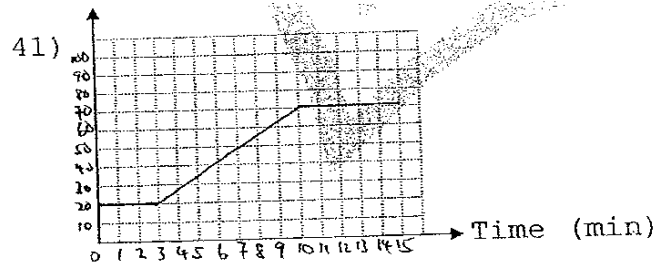

42a

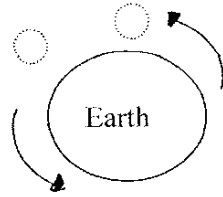

42b.



43a

Gear Z.

43b

Gear X.

44a

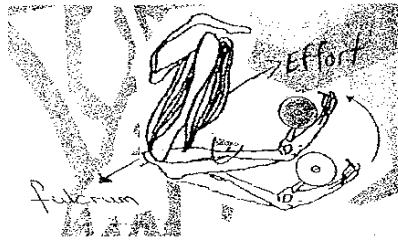

44b

It helps us to speed up work.

45a

P and R are conductors of electricity, while Q is an insulator of electricity.

45b (i)

No, Yes, Yes, Yes. .

(ii)

Yes, No, No, No

46a

16) a) set-up 1

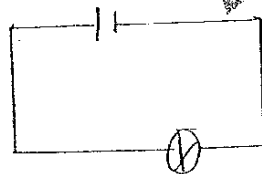

set-up2

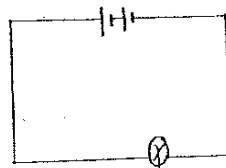

46b

The more number of dry cells, the brighter the bulb will be.