



NAN HUA PRIMARY SCHOOL  
SEMESTRAL ASSESSMENT 1 – 2010  
PRIMARY 6

SCIENCE

BOOKLET A

30 Multiple Choice Questions (60 marks)

Total Time for Booklets A and B : 1 hour 45 minutes

INSTRUCTIONS TO CANDIDATES

1. Write your name and index number in the space provided.
2. Do not turn over the page until you are told to do so.
3. Follow all instructions carefully.
4. Answer all questions.
5. Shade your answers in the Optical Answer Sheet (OAS) provided.

**Marks Obtained**

Booklet A		/ 60
Booklet B		/ 40
Total		/100

Name: \_\_\_\_\_ ( ) Class: P 6 \_\_\_\_\_

Date : 12 May 2010

Parent's Signature: \_\_\_\_\_

---

**Section A: (30 x 2marks = 60marks)**

For each question from 1 to 30, four options are given. One of them is the correct answer. Make your choice (1, 2, 3 or 4). Shade the correct oval (1, 2, 3 or 4) on the Optical Answer Sheet.

1. Which of the following statements about energy are true?

- A: Energy is needed to do work.
- B: Energy can be stored in our body.
- C: Energy is needed to exert a force.

- (1) A and B only
- (2) A and C only
- (3) B and C only
- (4) A, B and C

2. Which of the following source(s) of energy cannot be traced back to the Sun?

- A: Energy from food
- B: Energy from coal
- C: Energy from the stretched elastic band

- (1) A only
- (2) C only
- (3) A and C only
- (4) B and C only

3. Jessie threw a ball high into the air to a teammate across the court.

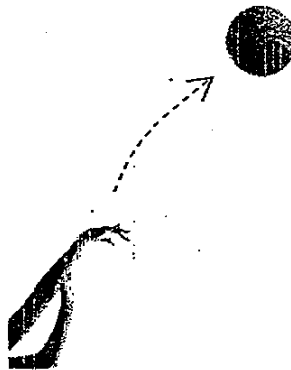

Which of the following statements about the activity shown above is true?

- (1) The gravitational force of the Earth helps the ball to move higher.
- (2) The gravitational force slows down the ball when it is coming down.
- (3) There is no gravity acting on a thrown ball when it is at its highest position.
- (4) The gravitational force causes the ball to change its direction of movement.



8. Study the food web below carefully.

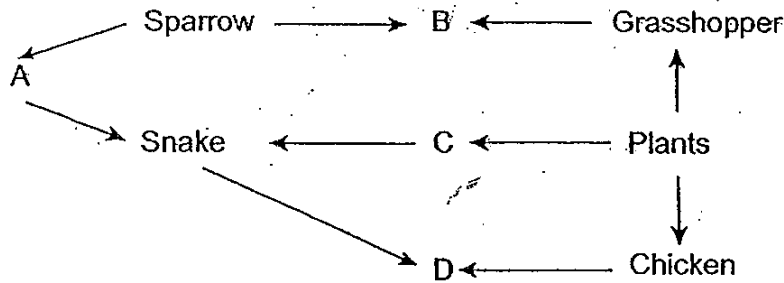

Which one of the following best represents an owl in the food web?

- |       |       |
|-------|-------|
| (1) A | (2) B |
| (3) C | (4) D |

9. The diagram below shows two beakers, X and Y, filled with different amount of water. The water in both beakers was heated up to  $80^{\circ}\text{C}$ .

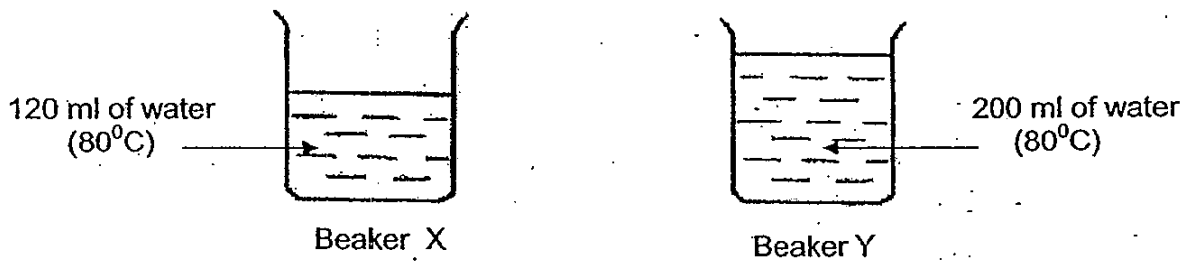

Which of the following statements are true about the two beakers of water?

- A: The water in both beakers has the same temperature.
- B: The water in both beakers has same amount of heat energy.
- C: The water in beaker Y has more amount of heat energy than beaker X.
- D: The water in beaker Y would evaporate faster than the water in beaker X.

- |                     |                     |
|---------------------|---------------------|
| (1) A and C only    | (2) C and D only    |
| (3) A, C and D only | (4) A, B and D only |

10. Matthew prepares 2 setups as shown below.

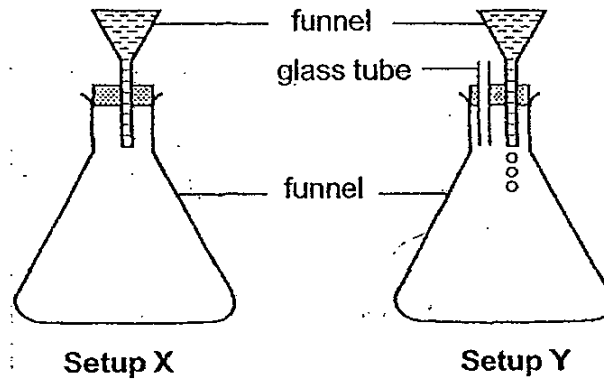

When he pours water into the funnels of both setups, it readily flows into the flask for Setup Y, but stops after a few drops for Setup X.

Which one of the following conclusions can be drawn from the observations in the 2 setups?

- (1) Only water can replace air.
- (2) Air and water occupies space.
- (3) Water and air does not have a fixed shape.
- (4) Only air does not have a fixed shape or volume

11. The graphs below show Yew Ming's activities, namely jogging, reading and sleeping, from 7 pm to 9 pm. Which one of the following graphs best represents the amount of energy used for each activity carried out by Yew Ming?

(1)

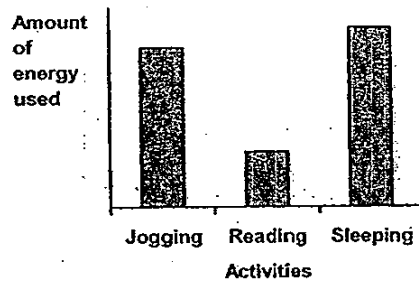

(2)

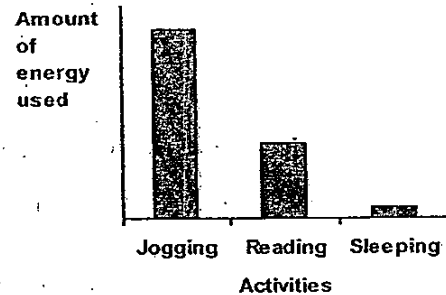

(3)

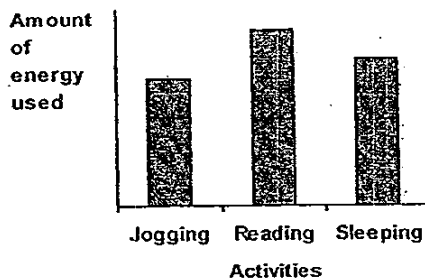

(4)

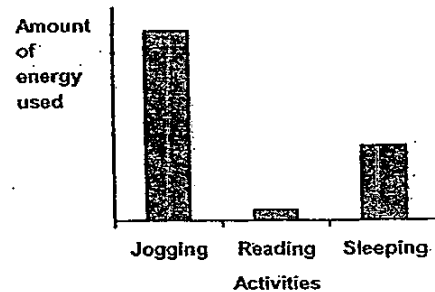

12. Which form(s) of energy is/are needed to operate a camera to take photographs using the flashlight?

- A: Heat energy
- B: Light energy
- C: Sound energy
- D: Electrical energy

- (1) D only
- (2) B and D only
- (3) A and C only
- (4) A, B and D only

13. A ball is bounced on the ground as shown below.

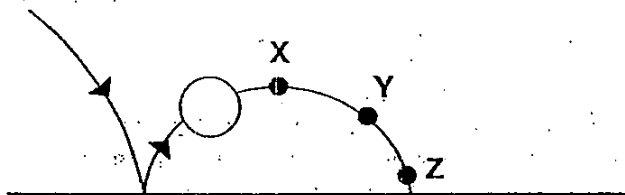

Which of the following statements about the ball above are true?

- A: The kinetic energy is zero at Point X.
- B: The kinetic energy is the highest at Point Z.
- C: The potential energy is the highest at Point X.
- D: The ball has both potential and kinetic energy at point Y.

- (1) A and D only
- (2) B and C only
- (3) A, B and D only
- (4) A, B, C and D

14. In Canada, government agencies in mountainous regions required vehicles to be installed with tire chains before driving through snow covered mountains.

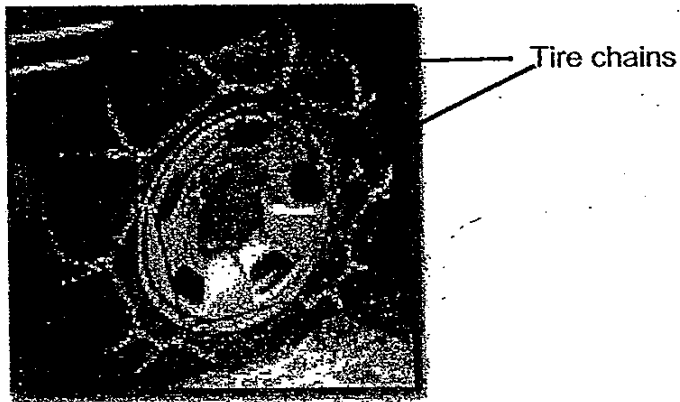

The tire chains installed on the vehicles ensure safety in snowy and icy condition as they help to \_\_\_\_\_

- A: prevent the car from skidding.
- B: decrease the gravitational force acting on the car
- C: increase frictional force between the car wheels and the snowy roads
- D: increase the elastic spring force of the tires when they move on the snowy road

- (1) A only
- (2) A and C only
- (3) B and C only
- (4) B, C and D only

15. Study the experiment setup below carefully.

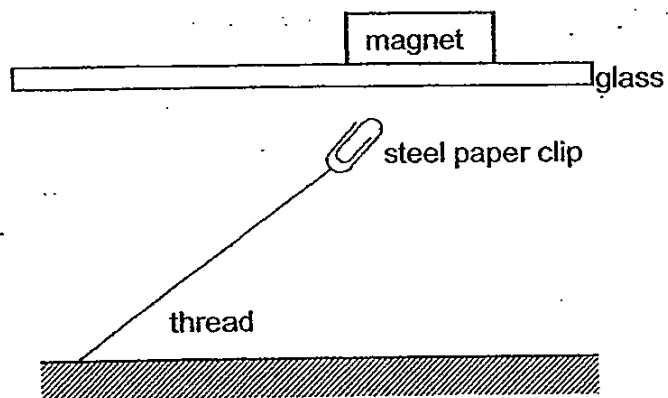

What can you conclude from this experiment?

- A: Magnetic force is very strong.
- B: Magnetic force can only be a pull.
- C: Magnetic force acts from a distance.
- D: Magnetic force can pass through glass.

- (1) A and B only
- (2) B and C only
- (3) C and D only
- (4) A and D only







20. The news announced the occurrence of the El Nino this year. The El Nino is a temporary warming up of the surface of the ocean which causes climate change. As a result, temperatures are set to soar to between 21 to 40°C when ~~he~~ <sup>the farmer</sup> starts planting new crops after the harvest.

The table below shows the temperature suitable for chilli, tomato and pumpkin seeds to germinate and grow respectively.

Seeds	Temperature (°C)	
	Minimum	Maximum
Chilli	20	43
Tomato	10	25
Pumpkin	17	41

Taking into consideration of the climatic change, a farmer has to decide to grow a crop which will have the best chance to survive in the changed environment.

Which fruit(s) is/are most likely to thrive as crop(s) with the climatic change?

- (1) Chilli only                      (2) Pumpkin only  
 (3) Chilli and Tomato only      (4) Chilli and Pumpkin only

21. The following are the descriptions of Organism X:

- a food consumer
- sensitive to light
- feeds on decaying matter
- needs to keep its skin moist all the time
- may die if too much water enters its body

In which habitat would Organism X most likely be found?

Habitat	Conditions			
	Amount of light	Area	Air	Soil
(1)	High	Large	Airy	Dry
(2)	High	Small	Most of the time still	Very wet
(3)	Low	Small	Still	Damp
(4)	Low	Large	Airy	Very wet

22. John collected some organisms from two leaf litter communities, A and B, in a forest. The number and type of organisms collected are shown in the graph below.

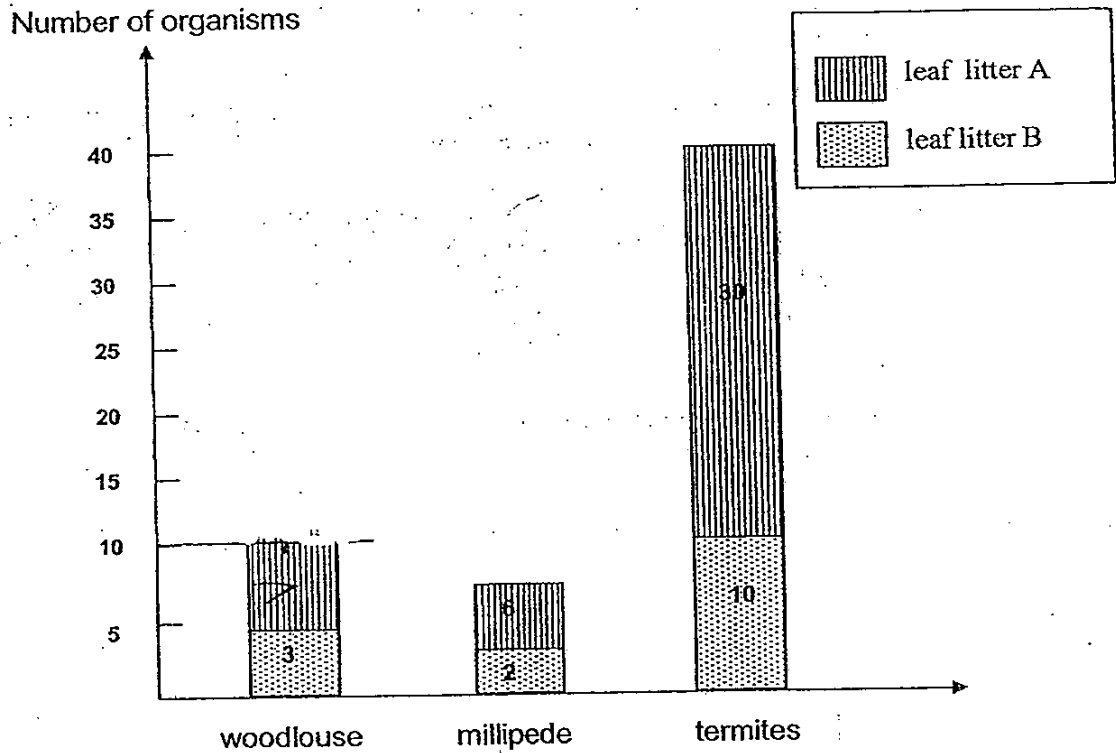

John observed that the conditions in both leaf litters A and B were similar and favourable for the survival of the organisms.

What is most likely to be the reason for the difference in the number of organisms in the two leaf litter communities?

- (1) Leaf litter A was infested with diseases.
- (2) Leaf litter A was formed earlier than Leaf litter B.
- (3) Leaf Litter A has higher humidity level than leaf litter B.
- (4) Leaf litter B is exposed to higher light intensity than Leaf litter A.

23. A steel company had been illegally dumping mercury compounds into the sea 3 years ago. Since then, the mercury had entered into food chains in ecosystem in that area. Mercury is extremely poisonous and it remains in animals and fishes for a long time. Which one of the graphs shows the change that would most likely to have happened to the population of birds that fed on the fishes in the area since the illegal dumping?

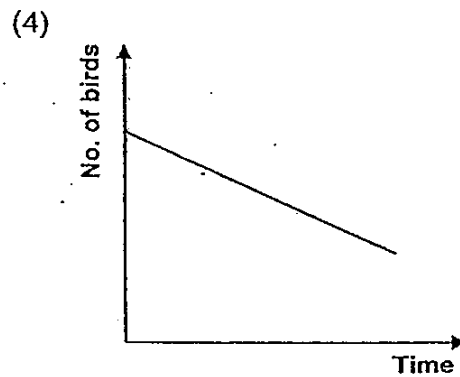
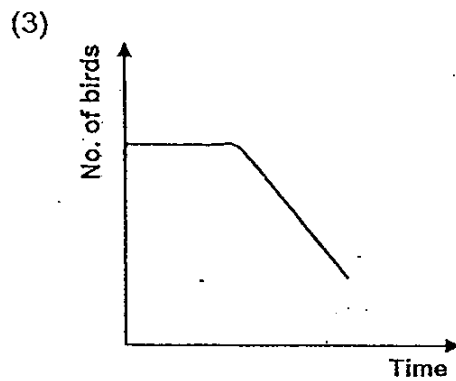
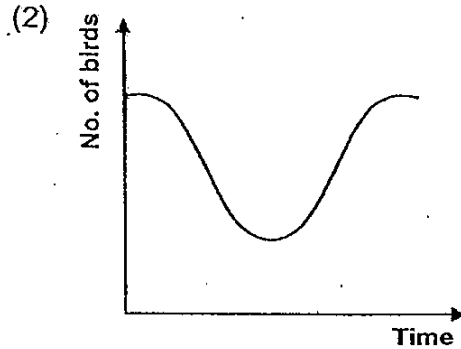
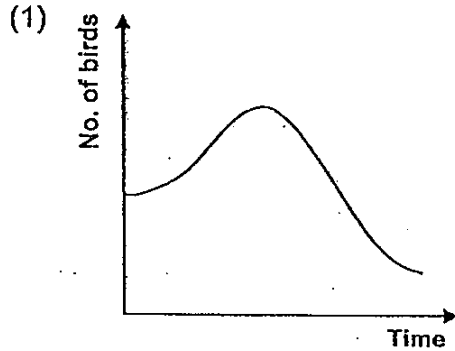

24. The food web below shows the food relationship among some organisms in a community.

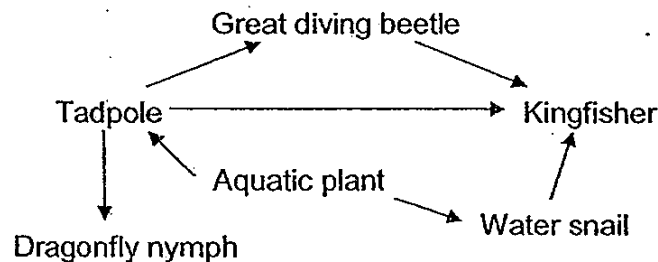

Which of the following statement/s about the food web is/are not true?

- A: The water snail and tadpole are omnivores.  
 B: The tadpole transfers energy to 3 other animals only.  
 C: The aquatic plant supplies all the energy needed in this food web.

- (1) A only  
 (2) A and B only  
 (3) A and C only  
 (4) A, B and C

25. Study the food web shown below.

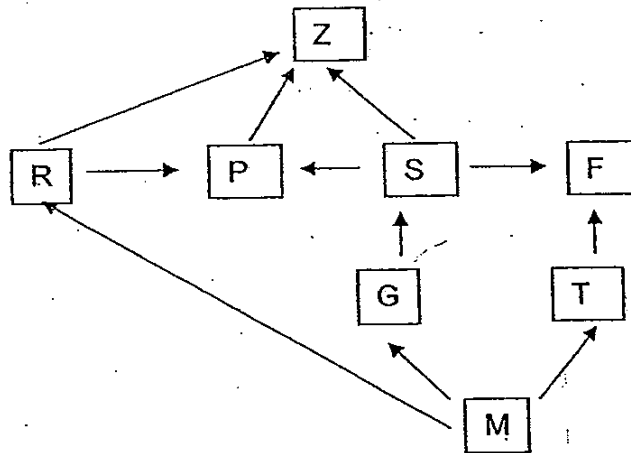

Which one of the following shows the correct grouping for the various organisms in the food web?

	Prey only	Predator only	Both prey and predator
(1)	G, M	F	P, T
(2)	G, M, R, T	Z	P, S, F
(3)	R, G, T	Z, F	P, S
(4)	R, S, T	P	F, Z, G

26. Study the food web.

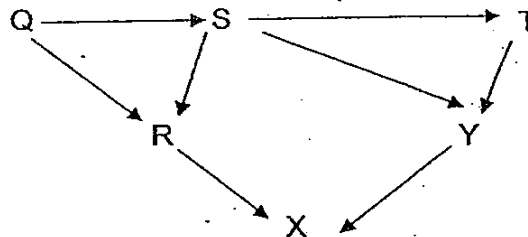

Which of the following descriptions about the above food web are true?

- A : S feeds on R.
- B : Q is a food producer.
- C : X is eaten by R and Y.
- D : Y is both a predator and a prey.

- (1) A and B only
- (2) B and D only
- (3) C and D only
- (4) A, B and C only

27. From the flow chart below, the digestive system, respiratory system and circulatory system work together to ensure our body gets food, water and oxygen for respiration to get energy.

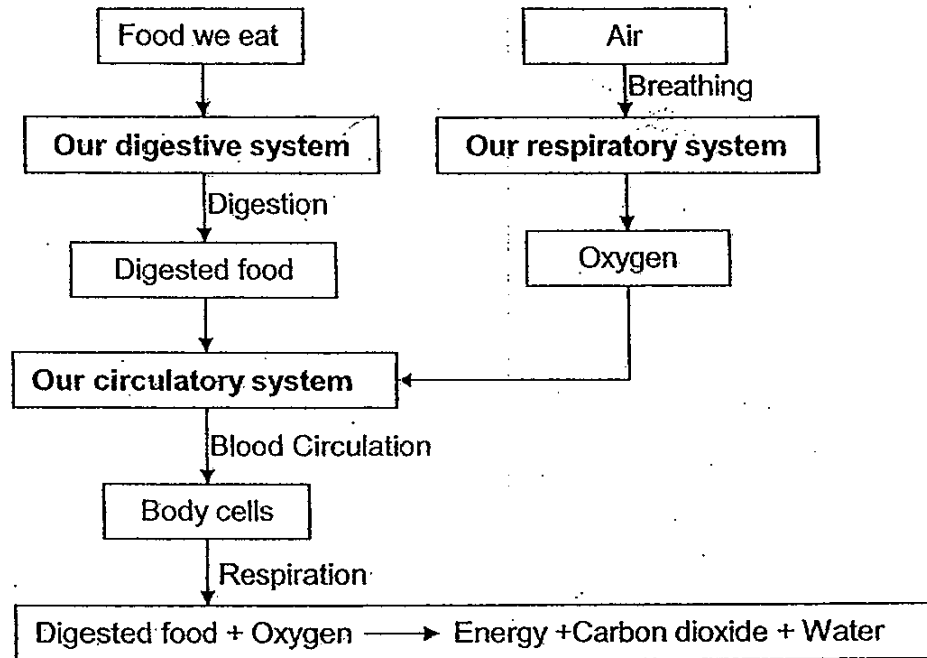

However, in the above process of getting energy, waste materials are produced. Which system or systems mentioned above work together to rid our bodies of the waste materials?

- (1) Digestive system only
- (2) Digestive and respiratory systems only
- (3) Digestive and circulatory systems only
- (4) Digestive, circulatory and respiratory systems

28. Roy observed three different types of cell. Cells A and B are from the same organism, while cell C is from another organism.

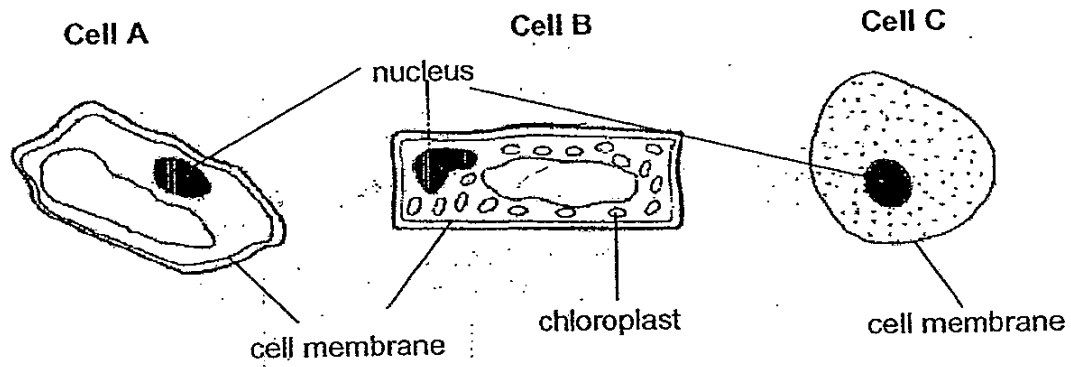

Which of the following statements are true?

- A: Only Cell B is a plant cell.
  - B: Only Cell C is an animal cell.
  - C: Cell A and B are plant cells.
  - D: Cell A and C are animal cells.
- (1) A and B only                      (2) B and C only  
(3) A and D only                      (4) A, B and C only

29. Jane placed 3 similar balsam plants in 3 similar beakers of water containing red dye. She trimmed off all the leaves from Plant A and some leaves from Plant B as shown in the diagram below.

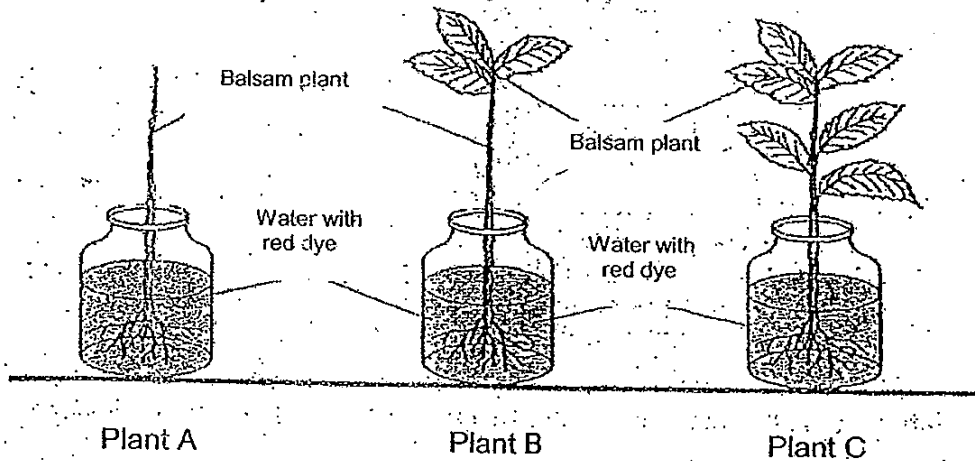

After one day, the amount of water left in each beaker is recorded in the table below.

Beaker	Amount of water in the beaker at first (ml)	Amount of water in the beaker after one day (ml)
A	250	242
B	250	235
C	250	214

What was the aim of Jane's experiment?

She was trying to find out if the \_\_\_\_\_

- (1) roots of the plant absorb water
- (2) leaves of the plant absorb water
- (3) stems help to transport water from the roots to the leaves
- (4) number of leaves affects the rate of water absorption by the plant



30. Study the diagram of our circulatory system below carefully.

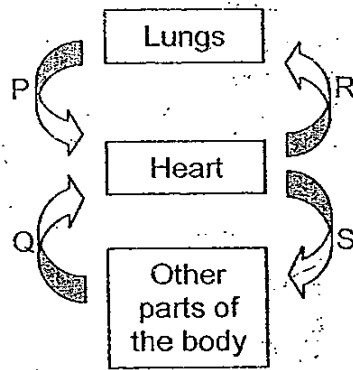

If P, Q, R and S represent blood vessels that connect various organs in our circulatory system, which blood vessels carry blood rich in carbon dioxide?

- (1) P and Q
- (3) Q and R

- (2) P and S
- (4) R and S



**NAN HUA PRIMARY SCHOOL  
SEMESTRAL ASSESSMENT 1 – 2010  
PRIMARY 6**

**SCIENCE**

**BOOKLET B**

**14 Open-ended questions (40 marks)**

**Total Time for Booklets A and B : 1 hour 45 minutes**

**INSTRUCTIONS TO CANDIDATES**

1. Write your name and index number in the space provided.
2. Do not turn over the page until you are told to do so.
3. Follow all instructions carefully.
4. Answer all questions.
5. Write your answers in this booklet.

**Marks Obtained**

**Section B**

	<b>/40</b>
--	------------

**Name:** \_\_\_\_\_ ( ) **Class:** P 6 \_\_\_\_\_

**Date :** 12 May 2010

**Parent's Signature:** \_\_\_\_\_

---

**Section B: (40marks)**

Write your answers to question 31 to 44.

The number of marks available is shown in brackets [ ] at the end of each question or part question.

31. An astronaut with a mass of 75 kg visited 3 moons namely X, Y and Z. He landed on each of the moons to collect some scientific data. He had to also record his weight on each of the moons as shown in the table below.

Moon	Astronaut's Weight (N = newtons)
X	60
Y	20
Z	40

- (a) Give a reason for the change in his weight observed on different moons. [1]

---

---

- (b) On which moon do you think would the greatest height be recorded if the astronaut were to exert the same force in his attempt to jump? Give a reason for your answer. [1]

---

---

Score	2
-------	---

32. Figure A shows a bimetallic strip which is made up of Metal X and Metal Y.

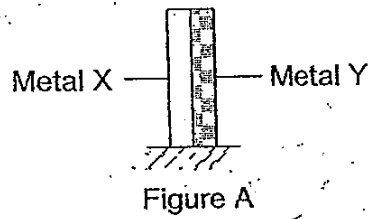
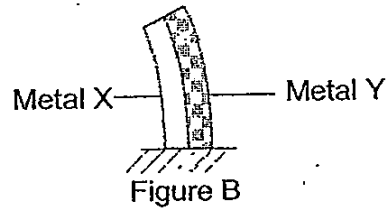

Figure B shows what will happen to the bimetallic strip when it is heated over a flame.



(a) Give a reason for the bend of the bimetallic observed in Figure B. [1]

---

---

Score	1
-------	---

32. The diagram shows the bimetallic strip in an electric circuit in an electric iron. In order not to burn the clothes, the bimetallic strip is used for the purpose of decreasing the temperature of the iron so that it can keep the temperature of the electric iron constant.

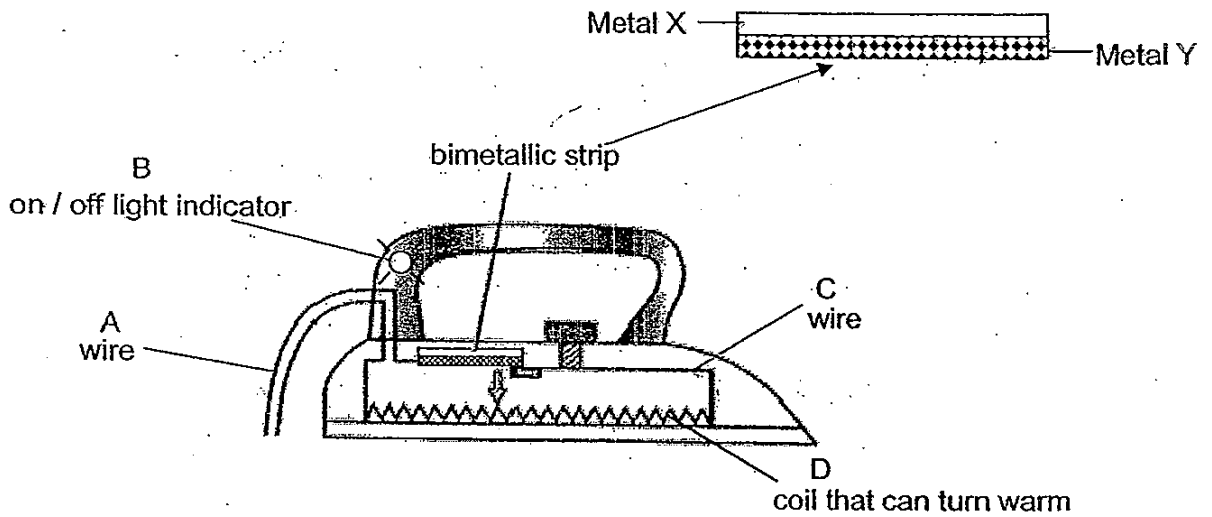

- (b) In the boxes below, write down the main form of energy at A, B, C and D when the switch is turned on. [2]

A	B	C	D
energy	energy	energy	energy

- (c) In the diagram below, draw the bimetallic strip when the iron gets very hot. Label Metal X and Metal Y clearly. [1]

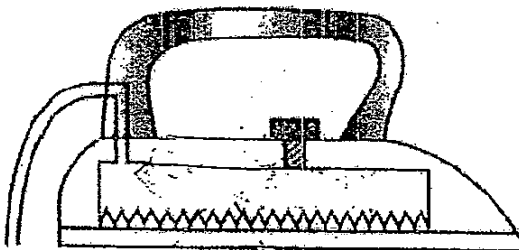

Score	3
-------	---

33. The diagram below shows a fruit tree and some of the animals that live on or are visitors to the tree.

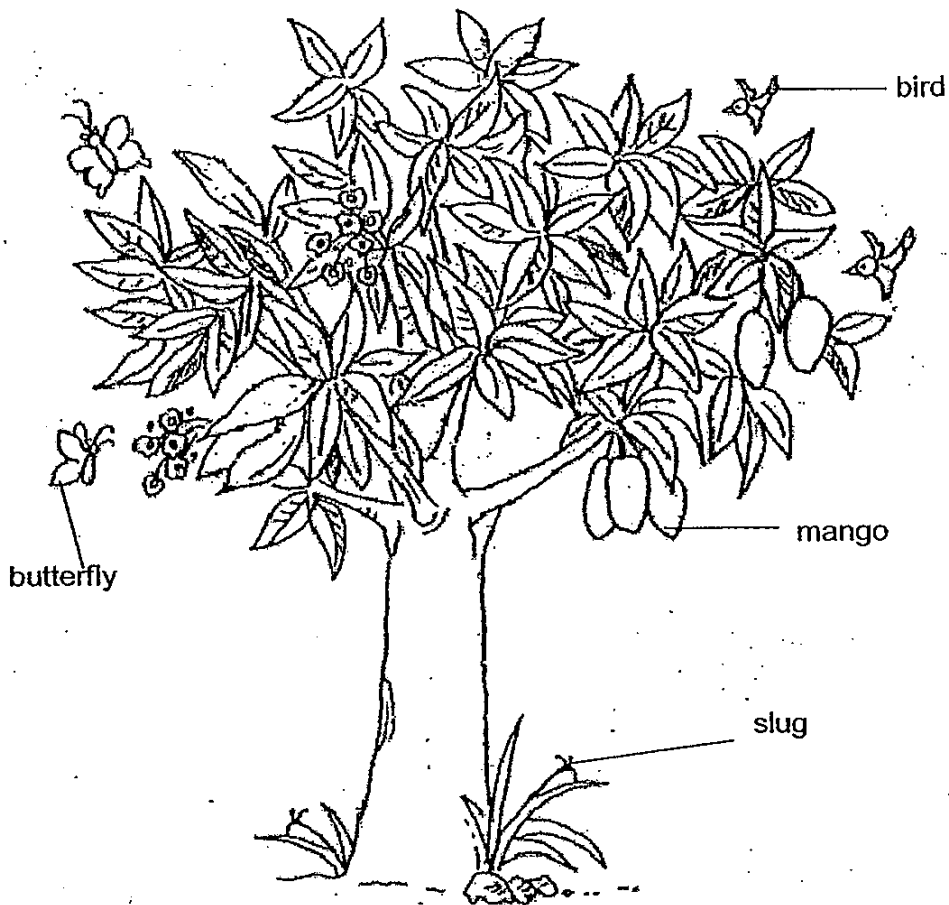

- (a) What kind of community is shown above? [1]

---

- (b) Which population will be immediately affected if all the mangoes on the tree are plucked? Explain your answer. [2]

---

---

---

Score	3
-------	---

34. Jean wants to find out if the use of Substance E will effectively limit the population of duckweeds that usually grows too quickly to cover up her school's eco-pond. She prepared 2 setups as shown in the diagram below.

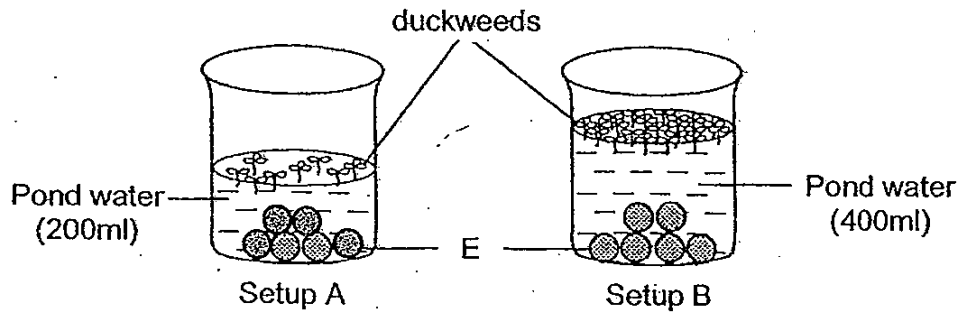

After a week, she was delighted to find that the duckweeds reduced in numbers in both setups. She decided to use the Substance E for her ~~pond~~ *school's eco-pond*. However, her father quickly cautioned her about her findings and pointed out that Setup A was wrong.

- (a) Describe clearly the ~~change~~ change Jean should make to Setup A to ensure that her experiment is a fair one. [2]
- (i) \_\_\_\_\_
- (ii) \_\_\_\_\_
- (b) Jean's father advised her that even if her test results showed that Substance E was effective in controlling the population of duckweeds, she should avoid using it in her ~~pond~~ *school's eco-pond*. Do you agree with Jean's father? Give a reason for your answer [1]
- \_\_\_\_\_
- \_\_\_\_\_

Score	3
-------	---

35. The following food chains occur among the populations in the community.

grass → grasshopper → bulbul → snake

grass → rabbit → snake

rose bush → caterpillar → bulbul → snake

rose bush → aphid → ladybird → bulbul → snake

(a) In the box below, construct a food web using the four given food chains above. [2]

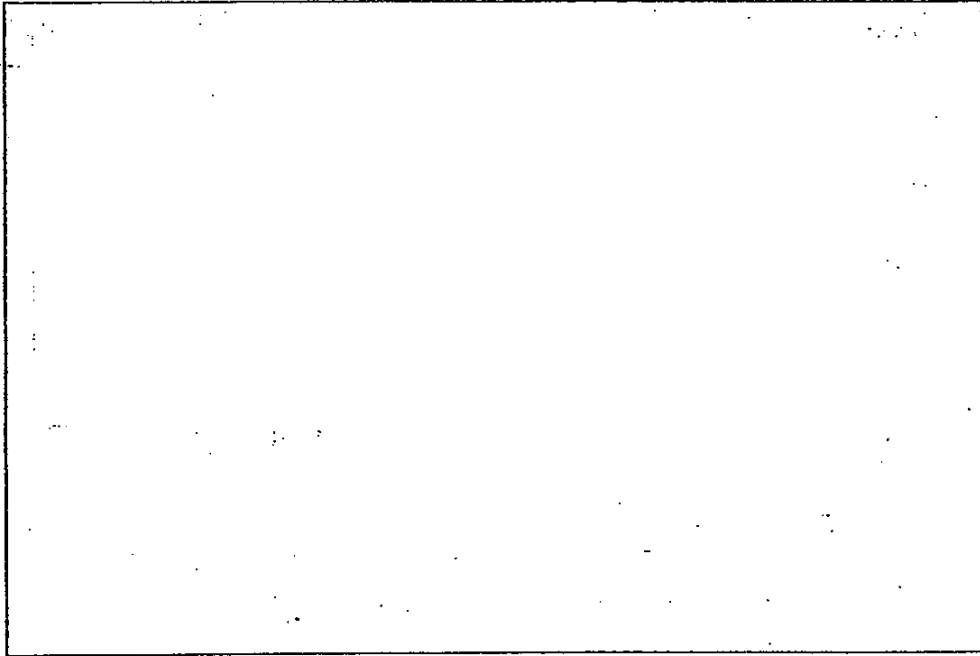

(b) State the likely habitat for the community of organisms above

[1]

---

Score	3
-------	---



36. John enrolled in Archery as a CCA. After his first lesson of learning the technique of handling the bow and arrow, John was eager to try hitting on the bull's eye.

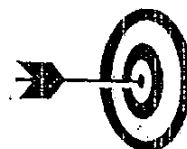
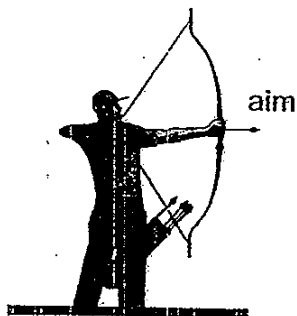

- (a) Name the force(s) that is/are acting on the moving arrow towards the bull's eye. [1]

---

---

- (b) John decided to challenge his two other teammates, Peter and Ken, in hitting the bull's eye.

The following describe how each of them aimed their arrow at the target:

John : Aimed the arrow directly at the bull's eye before shooting.

Peter : Aimed the arrow slightly above the bull's eye before shooting.

Ken : Aimed the arrow slightly below the bull's eye before shooting.

Who has the best chance of hitting the bull's eye? Give a reason for your answer. [1]

---

---

Score	2
-------	---

37. The diagram shows a toy grasshopper in a sealed transparent glass box:

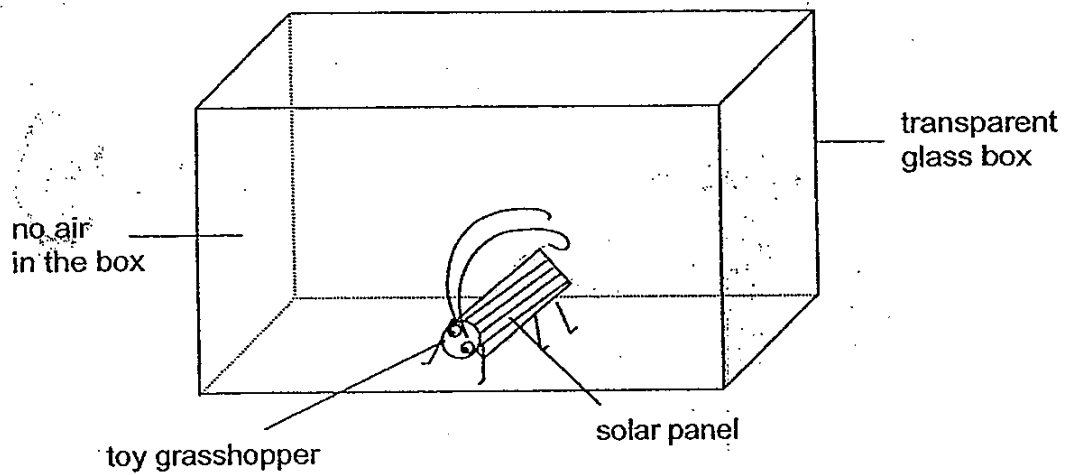

When a torch is shone on the toy grasshopper, the toy will hop around.

(a) What can be done to make the toy grasshopper hop faster? [1]

---

---

(b) What is the main energy conversion when the light is shone on the toy? [1]

---

---

(c) When the torch is removed, the toy grasshopper will ~~hopped~~ hop a few times and eventually stopped hopping. Other than the fact that the source of light was removed, explain clearly why the grasshopper stop hopping. [1]

---

---

Score	3
-------	---

38. Tim prepared 2 setups as shown below. He used a deep plastic tray and covered half of it with black paper. He kept one side warm and the other side cool. He then placed 9 organisms Z in the centre of the tray and observed them after half an hour.

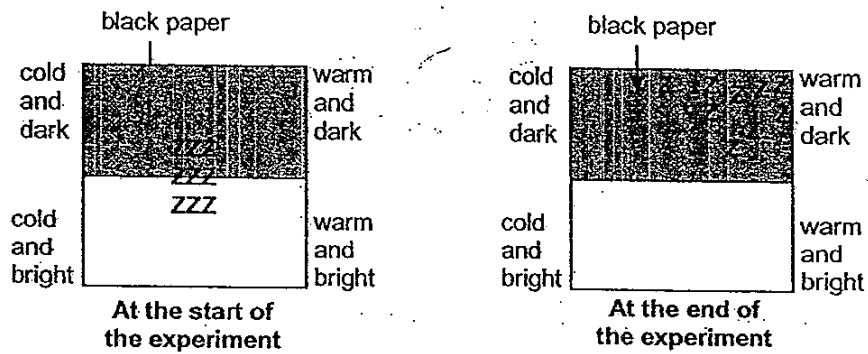

- (a) What is the aim of Tim's experiment?

[1]

---



---

- (b) Based on the above observations, what conclusion can Tim draw from the experiment?

[1]

---



---

- (c) What should he do to ensure his experiment is reliable?

[1]

---



---

Score	3
-------	---

39. One bright sunny day, Georgina placed a sealed bottle containing 2 tropical freshwater fishes and some aquatic plants on the window sill at 10a.m.

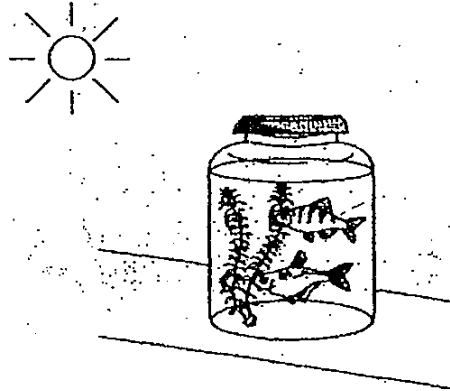

She observed the setup later in that afternoon at about 4pm.

- (a) Do you think the fishes would be alive by 4pm? Give a reason for your answer. [2]

---

---

---

- (b) She discovered that the fishes died at about 11pm the same day. Give a reason for the death of the fish. [1]

---

---

Score	3
-------	---

40. Pandas depend on bamboo leaves for food. There are currently a thousand pandas which are protected and thrive in Forest A, B & C (see map below). However, a deadly disease almost wiped out the bamboo plants in Forest C and a forest fire had occurred in Forest B.

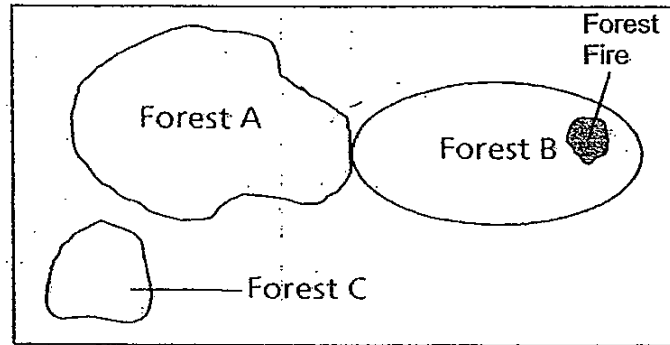

- (a) What do you think will happen to the pandas within the next weeks besides a drop in their population? [1]

---

---

- (b) How would the observation stated in (a) affect the pandas after two months? [2]

---

---

Score	3
-------	---

41. Study the food web carefully.

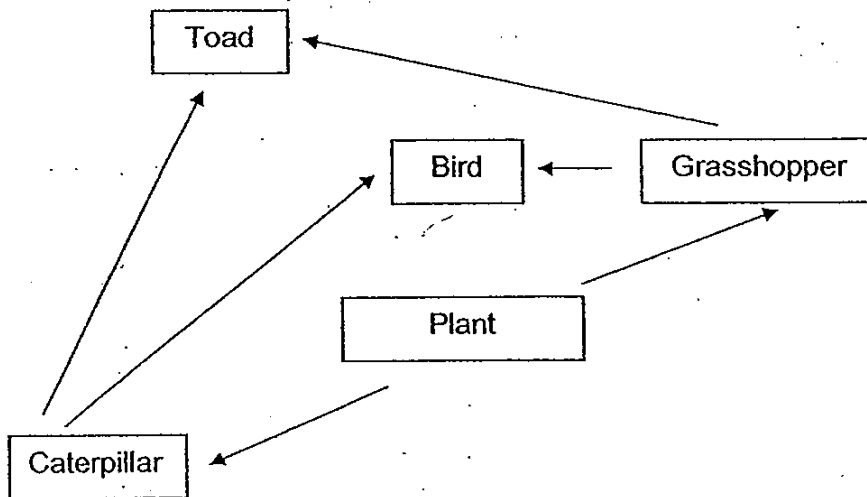

(a) Complete the classification of all the organisms in the food web into the food pyramid below. Write your answer in the table provided. [2]

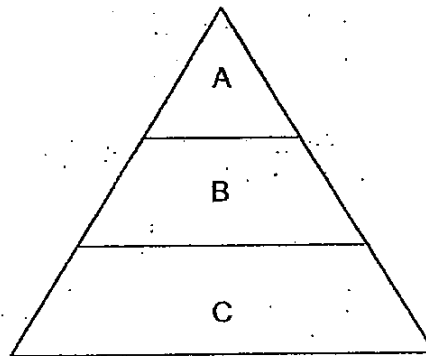

A	
B	
C	Plant

(b) Based on the food web shown above, what will happen to the population of the food producer, when the population of the toad increases? [1]

---



---

Score	3
-------	---

42. Pam carried out the following experiment to investigate the degree of transparency of clear glass and Materials X, Y and Z respectively.

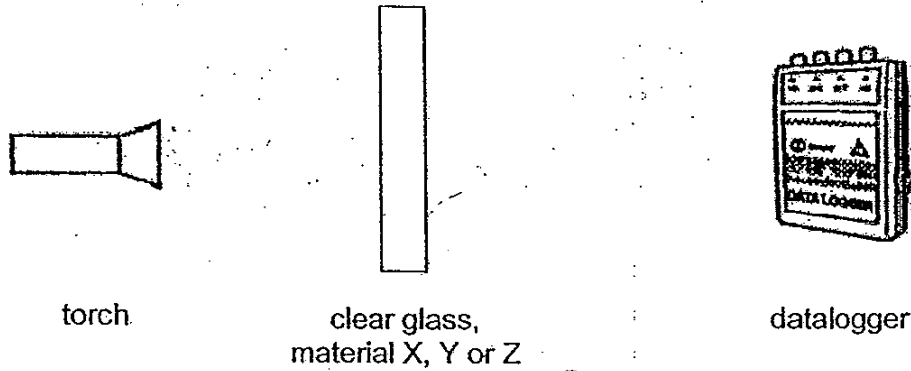

The bar graph below shows the result that Pam collected.

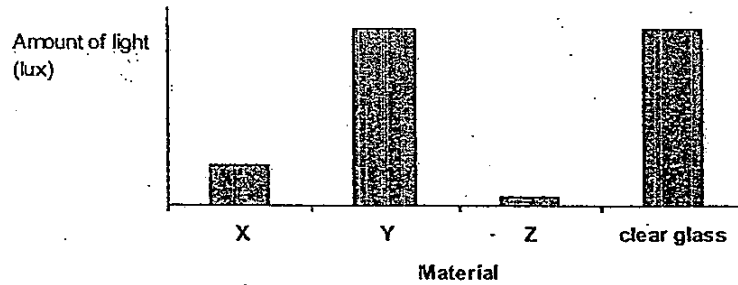

- (a) Based on the above results, write down clear glass and the Materials, X, Y and Z, in the classification table below correctly. [2]

Group A	Group B	Group C
Rubber	Tap water	Frosted glass

- (b) Which Material (X, Y or Z) can be used to make spectacle lens for reading? Give a reason for your answer. [1]

---



---

Score	3
-------	---

43. The diagram shows the top view of 2 similar sized electrical heating devices made from the same material.

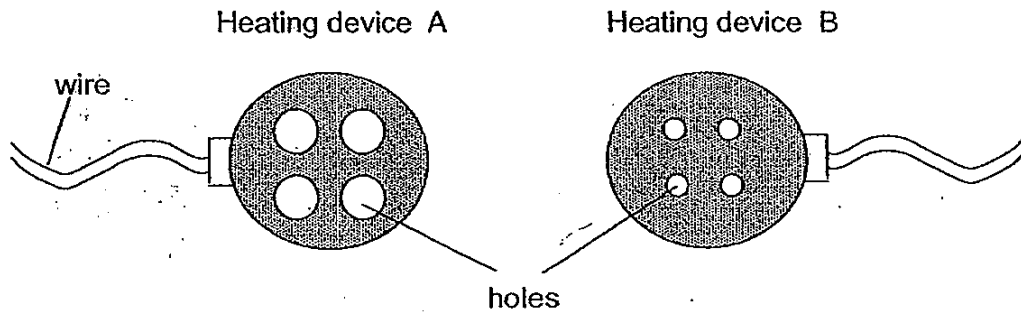

The diagrams below show the side view of 2 similar-sized electrical heating devices. Two identical cooking pots with the same amount of water at room temperature were placed on each of the heating device. The base of the kettle is of the same size as the heating device. pot

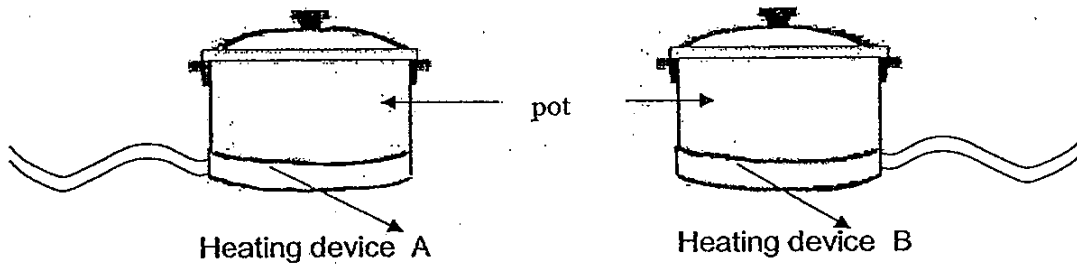

Which one of the pots of water will boil first? Give a reason for your answer. [2]

---

---

Score	2
-------	---



44. Mary set up 2 experiments to roll a steel ball from point A to point B and recorded the speed for the 2 experiments shown in the table below.

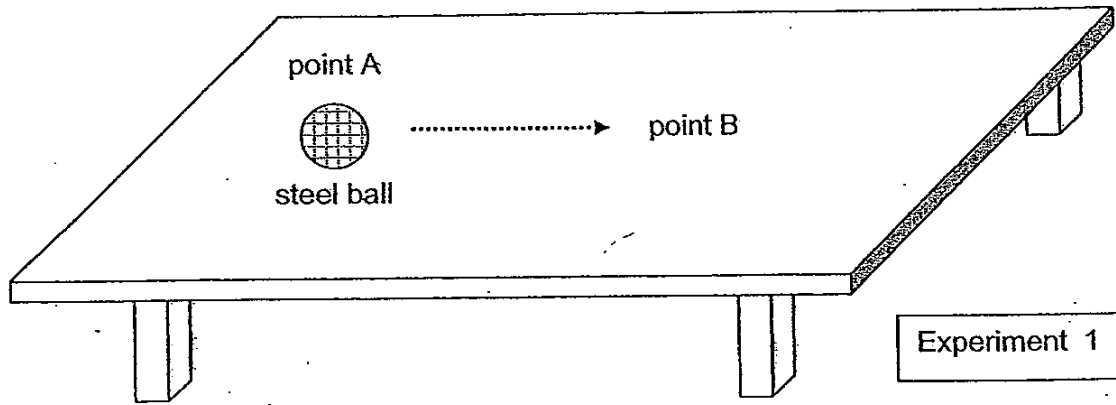

She placed object W on the table for Experiment 2 before she rolled the ball.

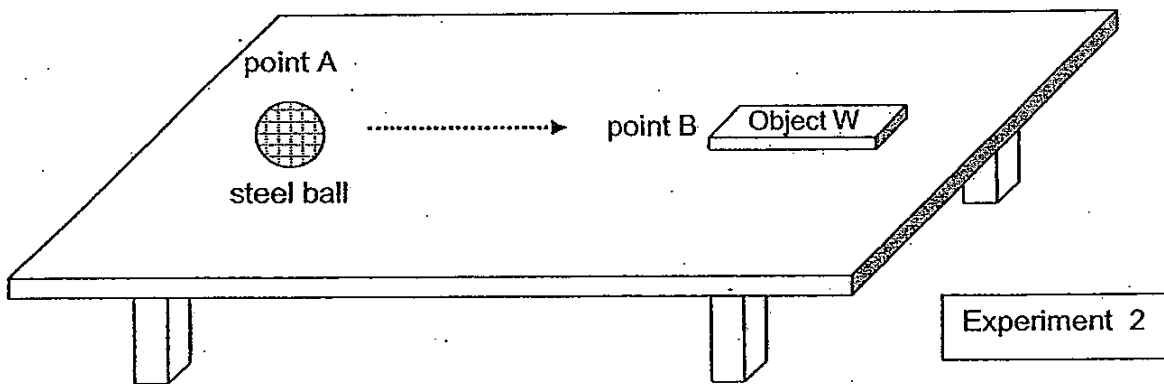

Set-up	Time taken for the steel ball to move from point A to point B (second)
1	20
2	9

- (a) Based on the results of the experiment, what is Object W most likely to be? [1]

---

- (b) Give a reason for the decrease in time for the steel ball to reach point B in Experiment 2. [2]

---



---

End of Paper.

Score	3
-------	---

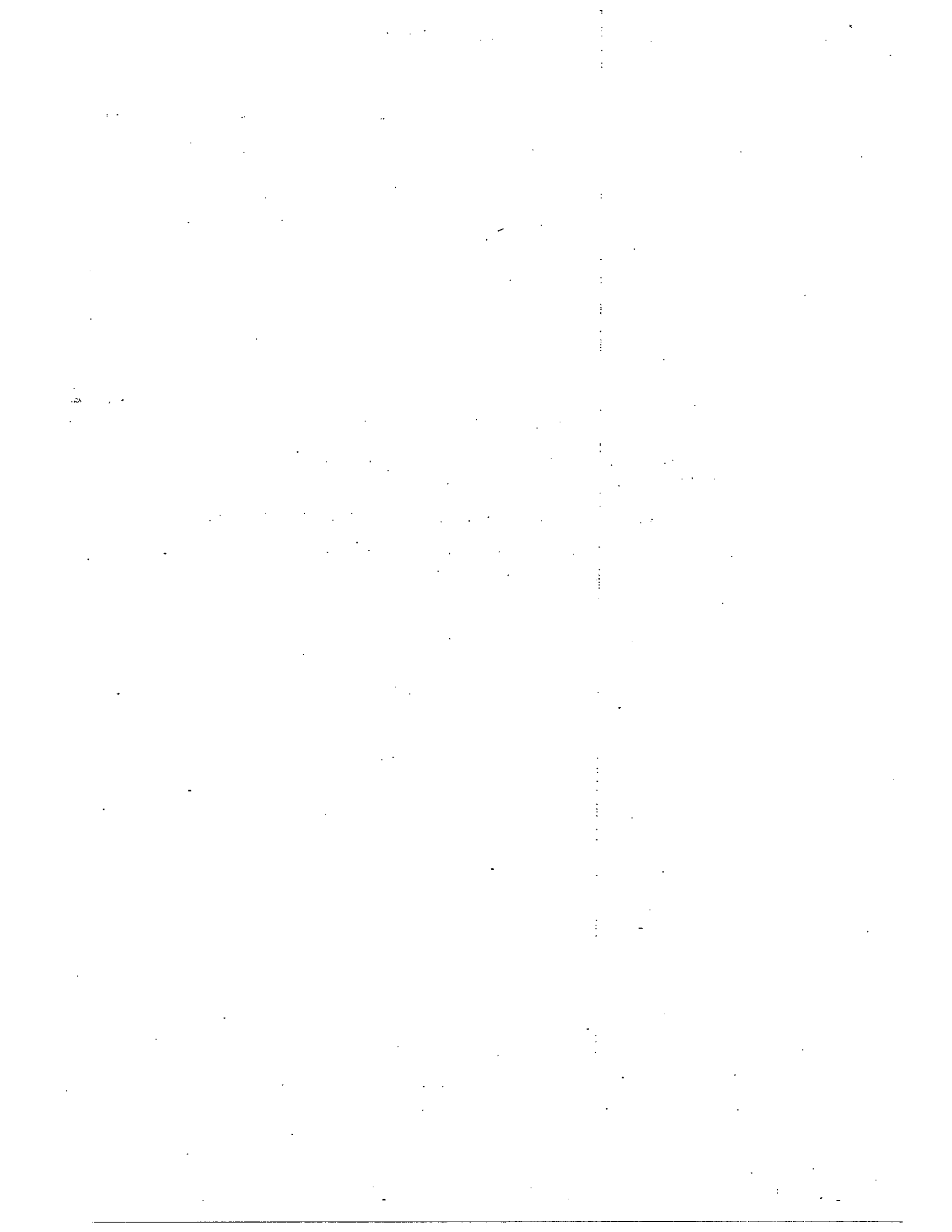

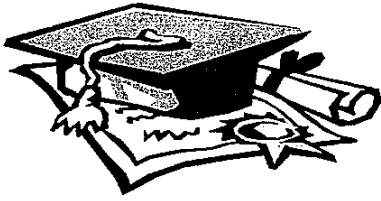

# ANSWER SHEET

**EXAM PAPER 2010**

**SCHOOL : NAN HUA PRIMARY  
SUBJECT : PRIMARY 6 SCIENCE**

**TERM : SA1**

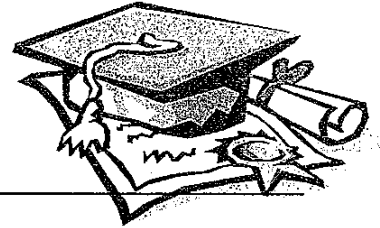

Q1	Q2	Q3	Q4	Q5	Q6	Q7	Q8	Q9	Q10	Q11	Q12	Q13	Q14	Q15	Q16	Q17
4	2	4	1	4	2	1	4	1	2	2	2	4	2	3	4	3

Q18	Q19	Q20	Q21	Q22	Q23	Q24	Q25	Q26	Q27	Q28	Q29	Q30
1	1	4	3	2	3	1	3	2	4	2	4	3

- 31)a)The different moons have different amount of gravity.  
b)On moon Y as there is the least gravity.

- 32)a)Metal Y expanded more than Metal X.  
b)electrical , light, electrical, heat.  
c)

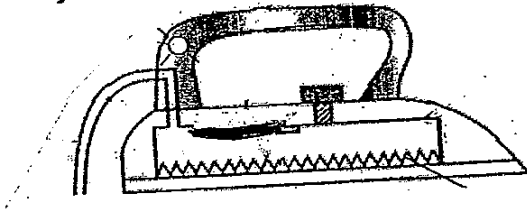

- 33)a)Single tree community.  
b)The birds will die as they eat mangoes as food.

- 34)a)i)She should add another 200ml of amount of pond water.  
ii)She must remove all of substance E.  
b)Substance E could be harmful to other organisms in her pond.

35)a)

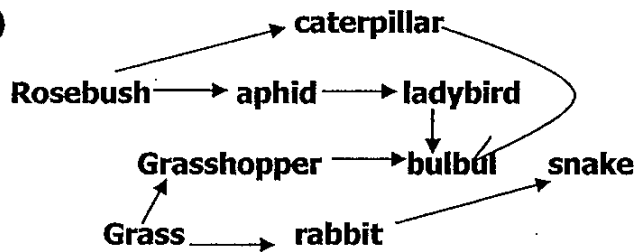

b)Garden

36)a)Gravity and Friction.

b)Peter as the gravity might pull the arrow down a bit.

37)a)Use more torches.

b)Light energy → electrical energy → kinetic energy.

c)Kinetic energy was converted to other forms of energy such sound energy and heat energy.

38)a)To find out if organisms Z prefers warm and dark places.

b)Organism Z prefers to live in a warm and dark environment.

c)Repeat the experiment a few times.

39)a)Yes. The aquatic plants used the sunlight and carbon dioxide released by the fish to photosynthesise to produce oxygen needed by the fish to respire.

b)There was not enough oxygen for respiration in the sealed bottle as the aquatic plant was not able to photosynthesise in the hence of sunlight to provide the oxygen.

40)a)The pandas from forest C and B will begin to move to forest A in search of food.

b)The population of panda will drop due to a reduction in habitat that led to competition for food.

41)a)A: Toad, bird. B: Caterpillar, Grasshopper.

b)The population of the food producer will increase.

42)a)Group B: clear glass, Y Group C: X, Z.

b)Material Y most light will be able to pass through the material and enters our eyes to enable us to see.

43)The pot of water on hot plate. B will boil first because the pot has greater contact area with the hot plate so the water will gain more heat from the hot plate for boiling.

44)a)A magnet.

b)The steel ball is made of magnetic material and was attracted by the magnet because magnetism can act at a distance.