



Rosyth School
Term Assessment 2023 (Term 1)
MATHEMATICS
Primary 6
Paper 1

Name : _____ ()

Class : Pr 6 - _____

Date : 21st February 2023 Parent's Signature: _____

Total Time for Booklets A and B : 25 min

—
Booklet B

Instructions to Pupils:

1. Do not turn over this page until you are told to do so.
2. Follow all instructions carefully.
3. Answer all questions.
4. Use a dark blue or black ballpoint pen to write your answers in the space provided for each question.
5. Do not use correction fluid/tape or highlighters.
6. The use of a calculator is not allowed.

Questions	Maximum Mark	Marks Obtained
Q 6 – 14	15	

* This paper consists of 6 printed pages altogether (including the cover page).

Questions 6 to 8 carry 1 mark each. Questions 9 to 14 carry 2 marks each. Show your workings clearly in the space provided for each question and write your answers in the spaces provided. For questions which require units, give your answers in the units stated.

Do not write in this space

All diagrams in this paper are not drawn to scale unless stated otherwise.
(15 marks)

6. The figure below is made up of 2 identical quadrants. Find the perimeter of the figure. ($\pi = 3.14$)

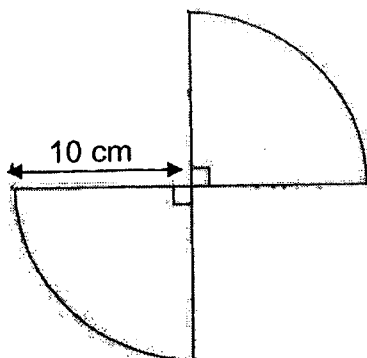

Ans: _____ cm

7. In a box, 25% of the keychains are from Thailand and 45% of the keychains are from Singapore. The remaining 45 keychains are from other countries. How many keychains are there in the box?

Ans: _____

8. The figure below is made up of a parallelogram EFGH and a triangle EJH. $\angle FGH = 78^\circ$, $\angle JHE = 36^\circ$ and $\angle JEF = 13^\circ$. Find the value of $\angle EJH$.

Do not write in this space

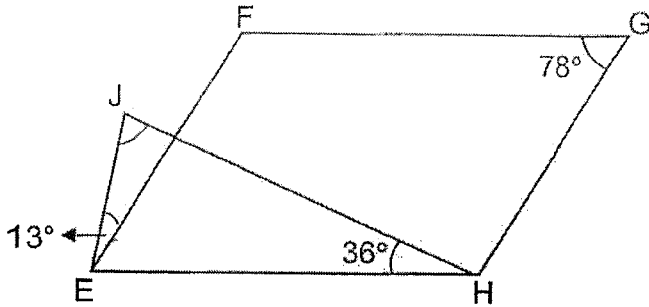

Ans: _____°

9. Draw and label the rhombus ABCD in the space provided below. The $\angle ABC$ in the rhombus is 65° . The line AB, which is 5 cm, has been drawn for you.

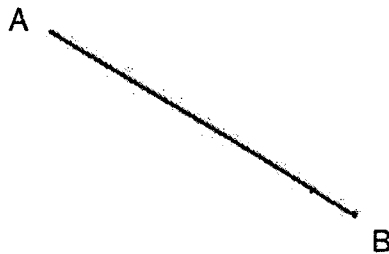

10. Jane and Patrick bought a box of badges. Jane took $\frac{7}{10}$ of the badges and Patrick took the rest. After Jane gave away 39 badges, Jane's number of badges left is $\frac{1}{6}$ of Patrick's number of badges. How many badges did Jane have in the end?

Do not write
in this space

Ans: _____

11. Kylie received a fixed sum of salary monthly. In January, she saved 20% of her salary. Her savings in February increased by 40%. Her total savings for the 2 months was \$480. What was the sum of salary given to her monthly?

Ans: \$ _____

12. In the figure below, ABCD is a rhombus and AEFD is a parallelogram. $\angle CDB = 47^\circ$. Find $\angle x$.

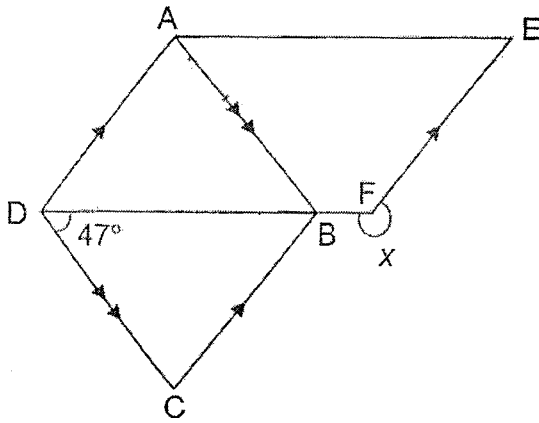

Do not write
in this space

Ans: _____ °

13. Five identical isosceles triangles are joined as shown in the figure below. Find the area of one such triangle.

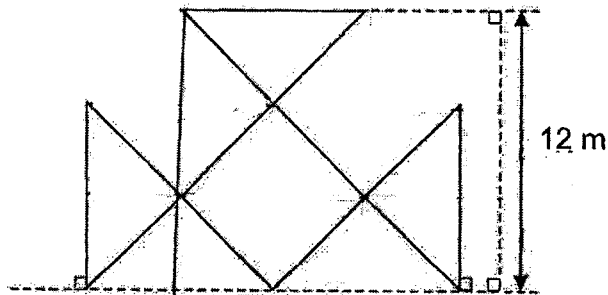

Ans: _____ m²

14. There is a total of 400 red and blue marbles in a container. After 64 red marbles are added into the container and 7% of the blue marbles are removed from the container, 443 marbles are left in the container. How many blue marbles are there in the container in the end?

Do not write
in this space

Ans: _____

End of paper
Have you checked your work?



Rosyth School
Term Assessment 2023 (Term 1)
MATHEMATICS
Primary 6

Name: _____ ()

Class: Pr 6 -

Date: 21st February 2023

Parent's Signature: _____

Time: 35 min

PAPER 2

Instructions to Pupils:

1. Do not turn over this page until you are told to do so.
2. Follow all instructions carefully.
3. Answer all questions.
4. Use a dark blue or black ballpoint pen to write your answers in the space provided for each question.
5. Do not use correction fluid/tape or highlighters.
6. The use of an approved calculator is allowed.

Questions	Maximum Mark	Marks Obtained
Q 15 to 20	20	

Section	Maximum Mark	Marks Obtained
Paper 1	20	
Paper 2	20	
Total	40	

* This booklet consists of 7 printed pages altogether. (including this cover page).

For Questions 15 to 20, show your working clearly in the space provided for each question and write your answers in the spaces provided. The number of marks available is shown in brackets [] at the end of each question or part-question. For questions which require units, give your answers in the units stated.

Do not write in this space

All diagrams in this paper are not drawn to scale unless stated otherwise.
(20 marks)

15. In the figure below, ABCD is a rectangle made up of 8 identical right-angled triangles.

The perimeter of rectangle ABCD is 364cm, what is the area of rectangle ABCD?

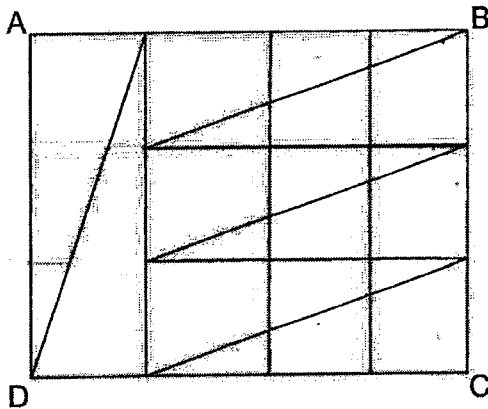

Ans: _____ cm² [2]

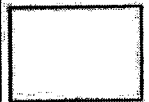

16. The pupils in a class are divided equally into Team A and Team B.
The ratio of the number of girls to the number of boys in Team A is 4 : 3
The ratio of the number of girls to the number of boys in Team B is 3 : 1.
What is the ratio of the number of girls to the number of boys in the class?

Do not write
in this space

Ans: _____ [3]

17. A rectangular piece of paper, as shown in Figure 1, is folded along the dotted line such that the total area of triangles A, B and C, as shown in Figure 2 is $\frac{5}{9}$ the area of the rectangular piece of paper.

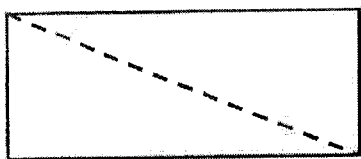

Figure 1

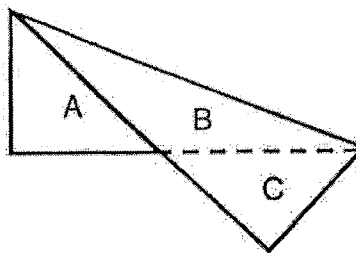
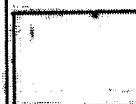

Figure 2

The area of triangle B is 24 cm^2 , find the area of the rectangular piece of paper.

Do not write in this space

Ans: _____ [3]



18. The figure shown below is made up of two identical squares, ABCD and CEFJ, a trapezium DEKJ and a triangle DEJ. The line DE is parallel to the line JK. $\angle CDE = 54^\circ$ and $\angle EJK = 33^\circ$

Do not write in this space

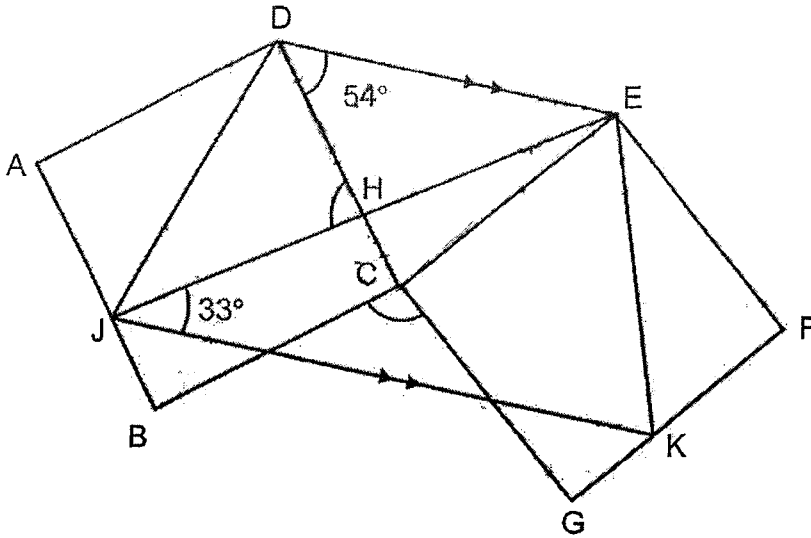

- (a) Find $\angle BCG$.

Ans: _____ [2]

- (b) Find $\angle DHJ$

Ans: _____ [2]

19. Three boxes, X, Y, and Z contained a total of 848 marbles at first. 120 marbles were removed from Box X. The number of marbles in Box Y was doubled. $\frac{1}{5}$ of the marbles in Box Z were given away. In the end, the ratio of the number of marbles in Box X to that of Box Y to that of Box Z was 1 : 2 : 1. How many marbles were there in Box X at first?

Do not write
in this space

Ans: _____ [4]

20. Below are the prices of facial masks from three different stores.

Store A	Store B	Store C
Original price: \$4.20 for 1 mask	Original price: \$25.90 for 1 pack of 10	Original price: \$3.80 for 1 mask
Promotion: 50% discount for all masks!	Promotion: For each pack bought, buy a 2 nd pack at 40% discount!	Promotion: Buy 5 get 4 free!

Do not write
in this space

Of the three stores, which store should Mrs Chong buy from if she wants to spend the least amount of money for 100 masks? How much would she need to pay?

Ans: Store _____ [1]

Ans: _____ [3]

End of paper
Have you checked your work?

SCHOOL : ROSYTH SCHOOL
 LEVEL : PRIMARY 6
 SUBJECT : MATH
 TERM : WA1 2023

Q1	Q2	Q3	Q4	Q5
4	3	2	1	3

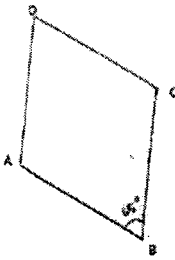
Q6) 71.40CM
Q7) 150
Q8) 53°
Q9)
 <p>A quadrilateral with vertices labeled A, B, C, and D. The interior angle at vertex B is marked as 64°.</p>
Q10) 3
Q11) \$1000
Q12) 227°
Q13) $16m^2$
Q14) 279
Q15) 8112
Q16) 37:19
Q17) $54cm^2$
Q18) a) 108° b) 87°
Q19) 344
Q20) \$207.20

TA 1 2023 - Selected Solutions

Q11

11. Kylie received a fixed sum of salary monthly. In January, she saved 20% of her salary. Her savings in February increased by 40%. Her total savings for the 2 months was \$480. What was the sum of salary given to her monthly?

Jan → 20%

Feb → 140% of 20 (Jan)
= 28

Jan and Feb → 20 + 28
= 48

48% of Sal \$ → 480

1% of Sal \$ → 10

Salary → 10 × 100
= \$1000

Q14

14. There is a total of 400 red and blue marbles in a container. After 64 red marbles are added into the container and 7% of the blue marbles are removed from the container, 443 marbles are left in the container. How many blue marbles are there in the container in the end?

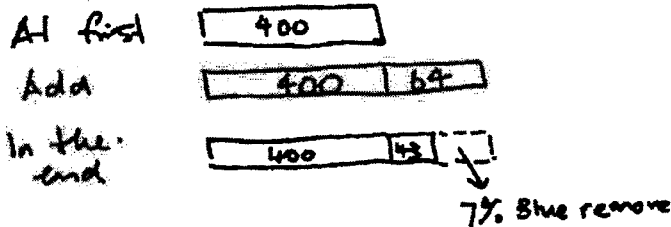

7% of Blue → 464 - 443

= 21

1% of blue → 21 ÷ 7

= 3

No of blue → 93 × 3

= 279

Q17

17. A rectangular piece of paper, as shown in Figure 1, is folded along the dotted line such that the total area of triangles A, B and C, as shown in Figure 2 is $\frac{5}{9}$ the area of the rectangular piece of paper.

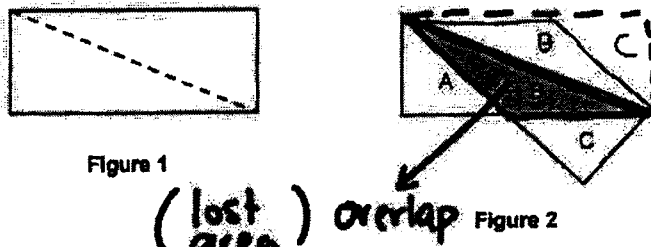

The area of triangle B is 24 cm², find the area of the rectangular piece of paper.

A + B + B + C ——— 9 units

A + B + C ——— 5 units

B ——— (9 - 5) units

= 4 units

4 units = 24

1 unit = 24 ÷ 4

= 6

9 units = 6 × 9

= 54

Q18

Sum = 93°

"C-rule"

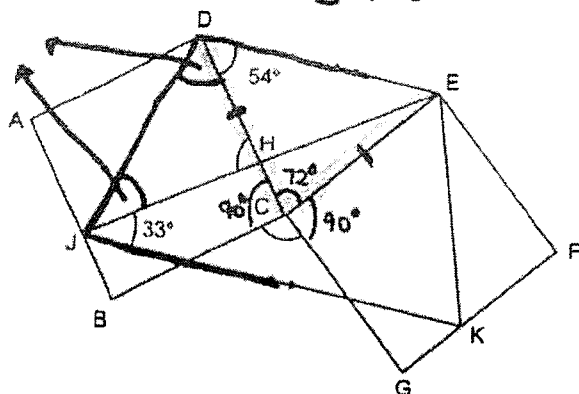

Find $\angle BCG$.

Triangle CDE is isosceles

$\angle DCE = 180 - 54 \times 2 = 72$

$\angle BCG = 180 - 72$ or $360 - 180 - 72 = 108$

Find $\angle DHJ$

Sum of $\angle DJH$ and $\angle HDJ = 180 - 54 - 33$

$= 93$

$\angle DHJ$

$= 180 - 93$

$= 87$

Q19

	X	Y	Z
In the end	1u	2u	1u
work backwards	-120	$\times 2$	$\frac{4}{5}T \rightarrow 1u$ $\frac{1}{5}T \rightarrow \frac{1}{4}u$ $\therefore -\frac{1}{4}u$
at first	1u+120	1u	$\frac{1}{4}u$ or $1.25u$

Total at first $\rightarrow (1u+120) + 1u + 1.25u = 3.25u + 120$

$3.25u \rightarrow 848 - 120 = 728$

$1u \rightarrow 224$

X (at first) $\rightarrow 224 + 120 = 344$

Q20

Shop A

$100 \times 2.1 = 210$

Shop B

1 set of 20 masks — $25.9 + 60\% \times 25.9 = 41.44$

5 sets of 20 (100) — $41.44 \times 5 = 207.20$

Shop C

1 set of 9 masks — $3.8 \times 5 = 19$

11 sets of 9 masks (99 Masks) — $11 \times 19 = 209$

100 masks — $209 + 3.8 = 212.80$

Ans: Store B

Ans: \$207.20

