



NAN HUA PRIMARY SCHOOL
SEMESTRAL ASSESSMENT 2 – 2013
PRIMARY FOUR
MATHEMATICS

INSTRUCTIONS TO CANDIDATES

1. Write your name, register number and class in the blanks provided.
 2. Do not turn over this page until you are told to do so.
 3. Follow all instructions carefully.
 4. Answer all questions.
 5. Shade your answers in the Optical Answer Sheet (OAS) provided for Questions 1 - 20.
-

Name : _____ ()

Class : Pr 4 _____

Date : 24 October 2013

Duration: -1 h 45 min

Parent's Signature : _____

Section A: Multiple Choice Questions (20 × 2 marks)

Questions 1 to 20 carry 2 marks each.

Of the 4 options given, only one is correct. Choose the correct answer (1, 2, 3 or 4) and shade the correct oval on the Optical Answer Sheet (OAS).

1. Sixty-five thousand and eighty-nine in figures is _____.

- (1) 65 890
- (2) 65 809
- (3) 65 089
- (4) 6 589

()

2. 23 758 rounded off to the nearest hundred is _____.

- (1) 23 700
- (2) 23 760
- (3) 23 800
- (4) 24 000

()

3. Which one of the following is a multiple of both 2 and 5?

- (1) 7
- (2) 15
- (3) 18
- (4) 20

()

4. Which one of the following fractions is in its simplest form?

- (1) $\frac{3}{7}$
- (2) $\frac{2}{8}$
- (3) $\frac{6}{9}$
- (4) $\frac{5}{10}$

()

5. Which one of the following mixed numbers is represented by the letter P in the number line shown?

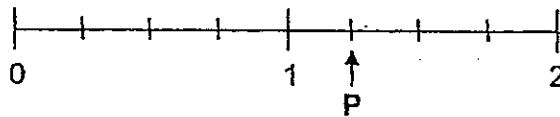

(1) $1 \frac{1}{4}$

(2) $1 \frac{3}{4}$

(3) $2 \frac{1}{4}$

(4) $2 \frac{3}{4}$

()

6. Arrange the following fractions from the smallest to the greatest.

$$\frac{1}{2} \quad \frac{4}{9} \quad \frac{8}{9}$$

(1) (smallest) $\frac{8}{9}$, $\frac{4}{9}$, (greatest) $\frac{1}{2}$

(2) $\frac{1}{2}$, $\frac{4}{9}$, $\frac{8}{9}$

(3) $\frac{4}{9}$, $\frac{1}{2}$, $\frac{8}{9}$

(4) $\frac{4}{9}$, $\frac{8}{9}$, $\frac{1}{2}$

()

7. A group of children went to the zoo. $\frac{5}{8}$ of them were girls.
There were 40 girls. How many pupils were boys?

- (1) 8
(2) 15
(3) 24
(4) 25

()

8. One of the lines in the figure below is parallel to AB.
Which line is parallel to AB?

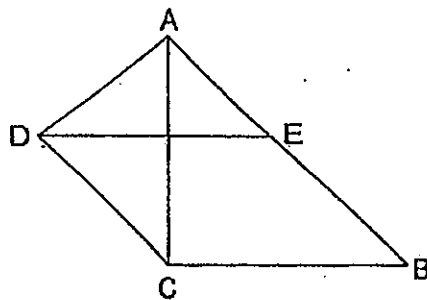

- (1) AC
(2) DC
(3) AD
(4) DE

()

9. 8 hundreds 5 ones 2 hundredths written as a decimal is _____.

- (1) 805.02
(2) 805.2
(3) 850.02
(4) 852.0

()

10. Ahmad had some stickers. After giving 140 stickers to each of his 4 friends, he had 5 stickers left. How many stickers did Ahmad have at first?

- (1) 540
- (2) 555
- (3) 565
- (4) 580

()

11. A notebook cost as much as 3 erasers. Grace paid \$2.40 for 1 notebook and 5 erasers. Find the cost of 1 eraser.

- (1) \$0.30
- (2) \$0.40
- (3) \$0.80
- (4) \$0.90

()

12. The total cost of a DVD player and 5 similar thumb drives is \$261. The DVD player costs 4 times as much as a thumb drive. Find the cost of each thumb drive.

- (1) \$29.00
- (2) \$43.50
- (3) \$52.20
- (4) \$65.25

()

13. Peter and Rhamat collected 1 900 stamps altogether. Rhamat collected 80 stamps more than Peter. How many stamps did Peter collect?

- (1) 870
- (2) 910
- (3) 960
- (4) 990

()

14. Siti is facing the park now. After making a $\frac{3}{4}$ -turn in the clockwise direction, where will she be facing?

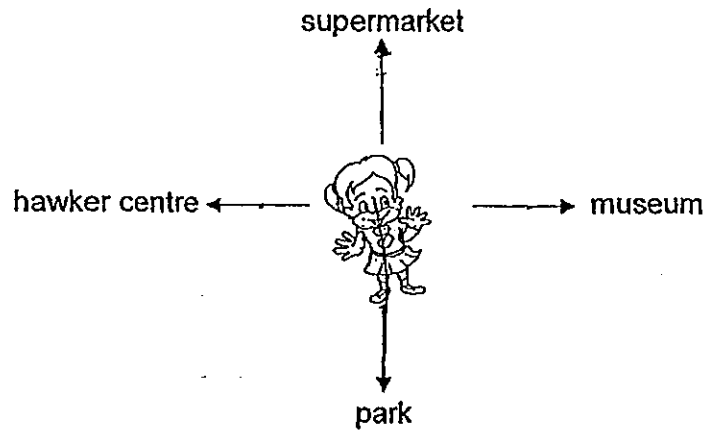

- (1) park
- (2) museum
- (3) supermarket
- (4) hawker centre

()

15. In the figure, how many of the marked angles are more than 90° ?

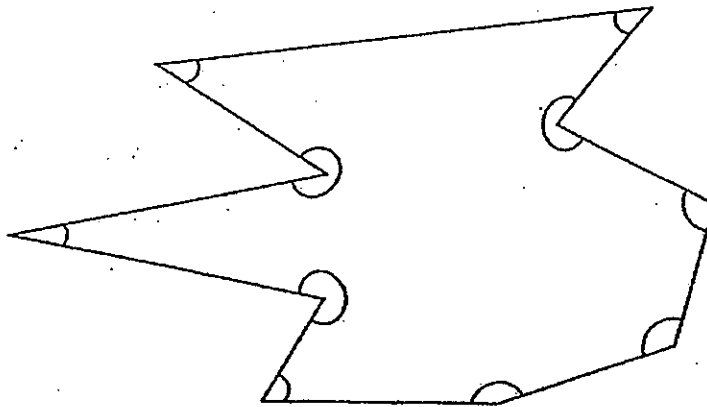

- (1) 7
- (2) 6
- (3) 5
- (4) 4

()

16. Mr Lim left his home for work at 08 25. He reached his office at 10 05.
How long was his journey?

- (1) 1 h 20 min
- (2) 1 h 40 min
- (3) 2 h 20 min
- (4) 2 h 40 min

()

17. Mariam spent $\frac{2}{5}$ of her savings on a present. She also bought a bag for \$15
and had \$30 left. How much savings did she have at first?

- (1) \$45
- (2) \$50
- (3) \$63
- (4) \$75

()

18. Janet is facing the post office now. After making a 225° anti-clockwise turn,
where will she be facing?

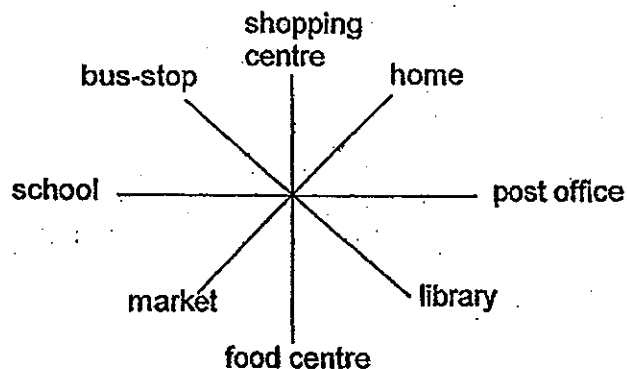

- (1) bus-stop
- (2) market
- (3) home
- (4) school

()

19. Philip paid \$10.80 for 3 cupcakes and 3 tarts. Each cupcake cost \$0.60 more than each tart. What was the cost of one tart?

- (1) \$1.50
- (2) \$1.70
- (3) \$1.80
- (4) \$1.90

()

20. The following figure which is not drawn to scale, is made up of 2 squares. The area of the smaller square is 36 cm^2 . What is the perimeter of the figure?

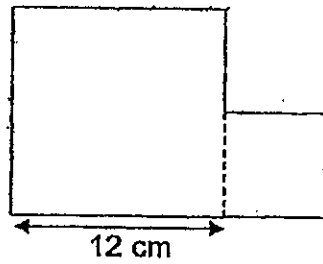

- (1) 54 cm
- (2) 60 cm
- (3) 66 cm
- (4) 180 cm

()

Section B: Open-ended Questions (20 × 2 marks)

Questions 21 to 40 carry 2 marks each.

Write out the correct answers for the following questions in the boxes provided.
Show your workings clearly and give your answers in the units provided.

21. What is the value of the digit 5 in 56 219?

22. Write the missing number in the number pattern below.

4 730, 4 850, 4 970, _____, 5 210

23. What fraction of the beads shown are grey in colour?

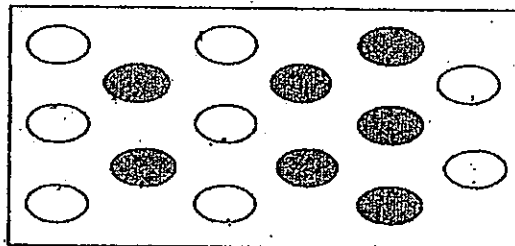

24. Write 7 hundredths as a decimal.

25. $9.6 - 0.97 =$ _____

26. In the figure, ABCD is a rectangle. Find the value of $\angle a$.

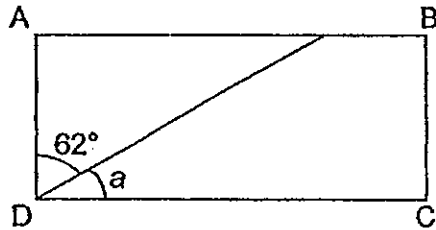

27. $5.07 + 2 =$ _____

28. Find the value of $\frac{3}{10} + \frac{13}{100}$.

29. Find the value of 4.97×6 .

30. Complete the drawing below by shading 2 more squares so that the dotted line is a line of symmetry.

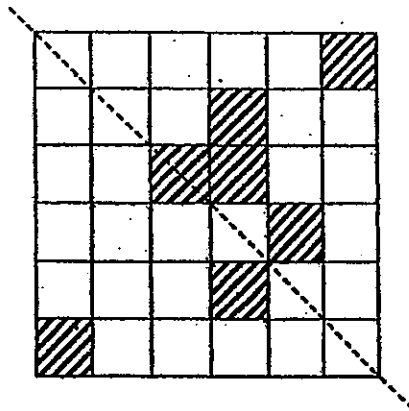

31. Mrs Kang had \$657. It was shared among her 3 daughters and a son. Her son received twice as much as the total amount received by the 3 daughters. Every daughter received the same amount of money. How much did each daughter receive?

\$

32. There were some passengers travelling in a train. After 52 passengers alighted and another 160 passengers boarded the train, there were three times as many passengers as before. How many passengers were there in the train at first?

passengers

33. The figure below, not drawn to scale, is made up of a square and a rectangle. BC is twice as long as AB. The area of the square is 64 cm^2 . What is the area of the rectangle?

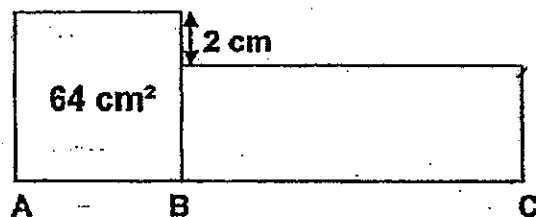

cm^2

A survey was conducted to find out the favourite ice-cream flavours of 100 pupils. The table below shows the result of the survey. Use the table below to answer questions 34 and 35.

Ice-cream flavour	Boys	Girls
Chocolate	20	6
Vanilla	40	?
Durian	?	2
Strawberry	15	?

34. Four times as many boys as girls took part in the survey. How many boys liked durian ice-cream?

boys

35. The number of girls who liked strawberry ice-cream was three times the number of girls who liked vanilla ice-cream. How many girls liked vanilla ice-cream?

girls

36. Phillip started his Science revision at 11.15 am. He revised for 1h 50 min. At what time did he finish his Science revision? Write your answer in 24-hour clock.

37. Complete the following tessellation in the space provided by adding 2 more unit shapes.

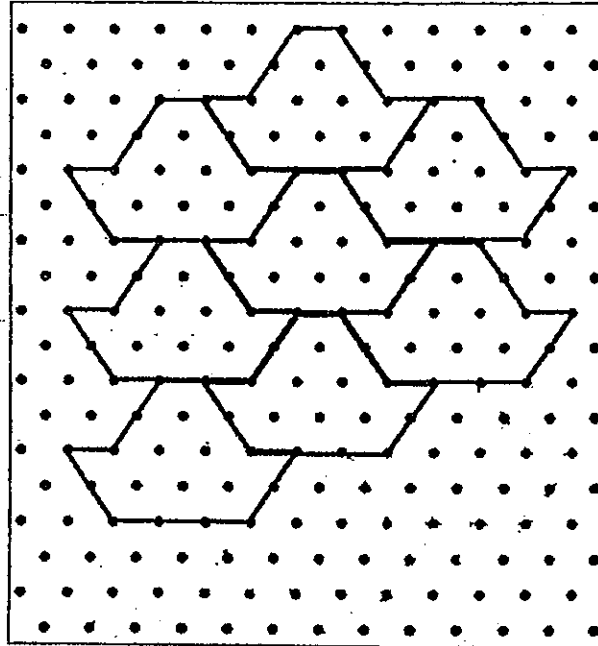

38. Five years ago, Mag was 3 times as old as Lenny.
Their total age now is 66 years. How old is Lenny now?

years old

39. Raj had twice as many fifty-cent coins as twenty-cent coins. The total value of the twenty-cent coins he had could be exchanged for 1 two-dollar note. How much money did Raj have in all?

\$

40. Sheila used triangles and lines to make patterns of squares as shown in the diagram below. Study the patterns and the table below and answer Question 40.

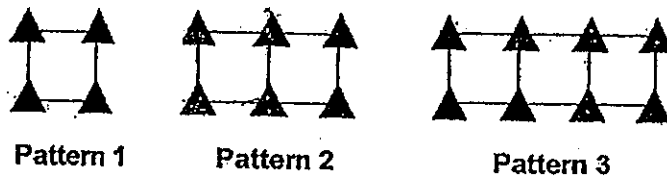

Number of squares	Number of triangles	Number of lines
1	4	4
2	6	7
3	8	10

How many squares are formed with 186 triangles?

squares

Section C (5 × 4 marks)

For each of the following questions, show your workings and mathematical statements in the space below each question. Write your answer in the answer space provided.

41. Ali is 0.05 m shorter than Ben. Cindy is 0.12 m taller than Ben.
If Cindy is 1.45 m tall, how tall is Ali ?

42. Raynie had 5 metres of rope. She cut them into 3 pieces. The second piece was 45 cm shorter than the first piece and the third piece was 95 cm long.
Find the length of the second piece of rope.

43. The figure below shows a photo frame that measures 30 cm by 22 cm. A picture is mounted on the frame leaving a border of 2 cm around it. Find the area of the frame that is not covered by the picture.

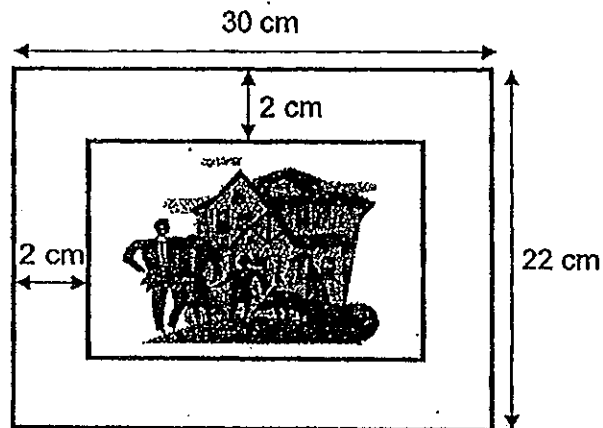

44. Mrs Lau bought a bag of beads to be shared between Amanda and Dora. Amanda had 52 more beads than Dora. Then Dora gave Amanda 20 beads. In the end, Amanda had 5 times as many beads as Dora. How many beads did Amanda have at first?

45. A rectangular piece of paper is folded at a corner as shown in the figure below. (The figure is not drawn to scale.)

- a) What is the perimeter of the piece of paper at first ?
- b) What is the area of the piece of paper at first ?

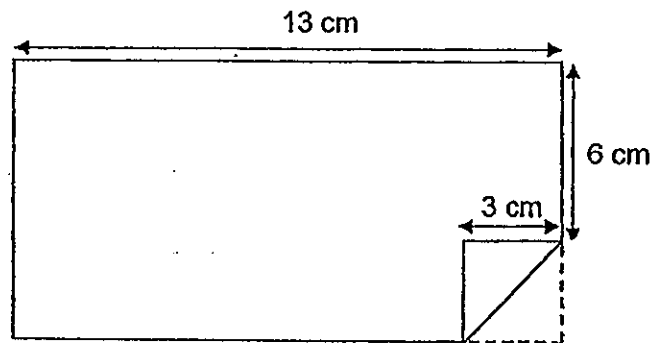

End of Paper

ANSWER SHEET

EXAM PAPER 2013

SCHOOL : NAN HUA PRIMARY SCHOOL
 LEVEL : PRIMARY 4
 SUBJECT : MATHEMATICS
 TERM : SA2

Booklet A

Q1	Q2	Q3	Q4	Q5	Q6	Q7	Q8	Q9	Q10	Q11	Q12	Q13	Q14	Q15	Q16
3	3	4	1	1	3	3	2	1	3	1	1	2	2	2	2

Q17	Q18	Q19	Q20
4	2	1	2

- 21. 50 000
- 22. 5040
- 23. $\frac{7}{15}$
- 24. 0.07
- 25. 8063
- 26. 28
- 27. 7.07
- 28. $\frac{43}{100}$
- 29. 24.82
- 30.
- 31. 73
- 32. 54
- 33. 96
- 34. 5
- 35. 3
- 36. 13 05
- 37.
- 38. 19
- 39. 12.00
- 40. 92
- 41. $1.45 - 0.12 = 1.33$
 $1.33 - 0.05 = 1.28$
- 42. $500 - 95 = 405$

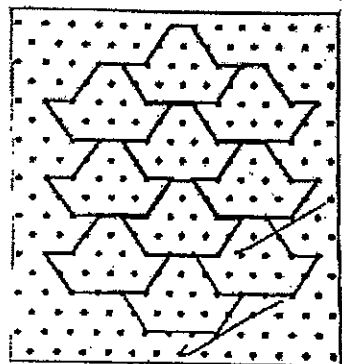
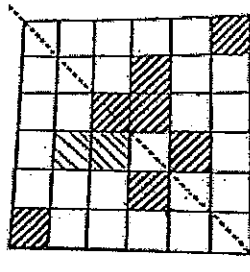

$$405-45=360$$

$$360/2=180$$

$$43.2+2=4$$

$$30-4=26$$

$$22-4=18$$

$$26 \times 18 = 468 \text{ CM square}$$

$$30 \times 22 = 660$$

$$660 - 468 = 192$$

$$44.92/4=23$$

$$92+23=115$$

$$115-20=95$$

$$45a).13+13=26$$

$$6+3=9$$

$$9 \times 2 = 18$$

$$18+26=44$$

$$45b).9 \times 13 = 112$$