



RAFFLES GIRLS' PRIMARY SCHOOL
PRELIMINARY EXAMINATION
2012

Section A	60	
Section B	40	
Your score out of 100 marks		
Highest score	Class	Level
Average score		
Parent's signature		

Name: _____ Index No: _____ Class: P 6 _____

2 August 2012 SCIENCE Attn: 1 h 45 min

SECTION A (30 X 2 marks)

For each question from 1 to 30, four options are given. One of them is the correct answer. Make your choice (1, 2, 3 or 4). Shade the correct oval on the Optical Answer Sheet.

1. The diagram below shows how some organisms (*not drawn to scale*) are grouped.

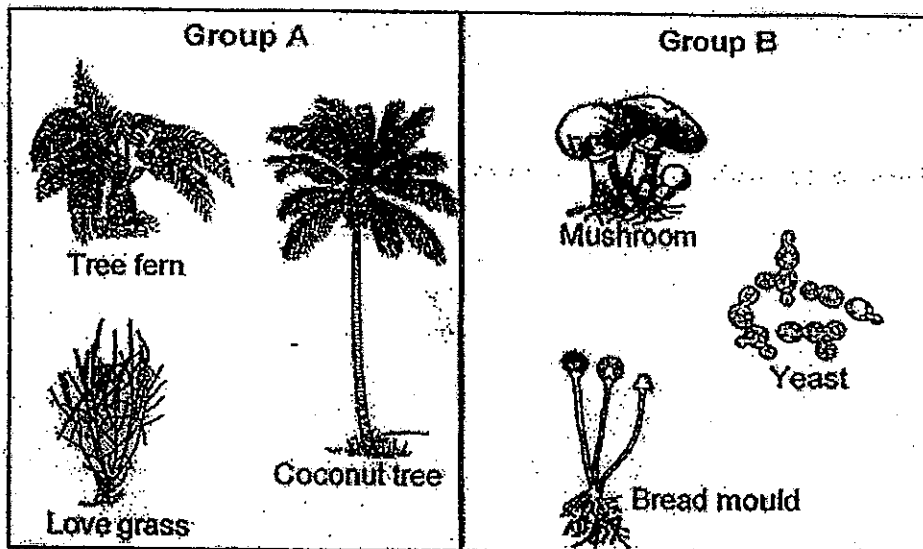

Which of the following statement(s) is/are correct?

- A The organisms in Group A and Group B reproduce by spores.
 - B The organisms in Group A and Group B are non-flowering plants.
 - C The organisms in Group A contain chlorophyll but not those in Group B.
 - D The organisms in Group B are micro-organisms but not those in Group A.
- (1) C only
(2) A and B only
(3) C and D only
(4) B, C and D only

2. Study the flow chart shown below.

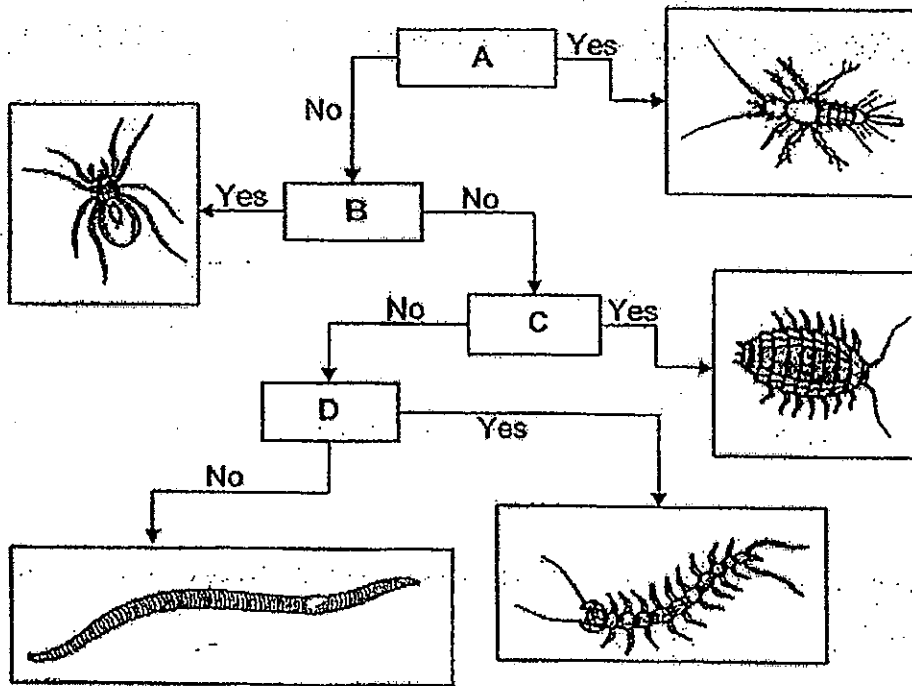

Which of the following shows the correct criteria for classification represented by A, B, C and D respectively?

	A	B	C	D
(1)	Has 3 body parts	Has 8 legs	Has broad body	Has 2 legs per segment
(2)	Has 2 body parts	Has 3 body parts	Has 2 legs per segment	Has broad body
(3)	Has 8 legs	Has 2 legs per segment	Has 2 body parts	Has 6 legs
(4)	Has 6 legs	Has broad body	Has 8 legs	Has 2 legs per segment

3. Each letter in the diagram below represents a stage in the life cycle of a butterfly.

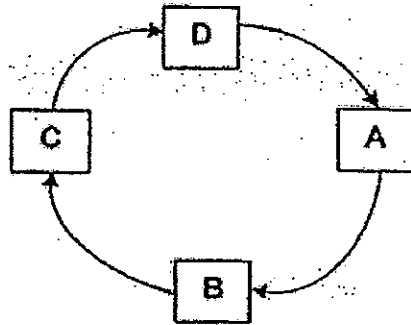

Which of the following statements is true if B represents the adult stage?

- (1) At Stage A, it has wings to fly around.
 - (2) At Stage C, it spends most of its time eating.
 - (3) At Stage D, it moults several times as it grows.
 - (4) At Stage D, it does not eat and does not move around.
4. Mary placed identical number of seeds over cotton wool in 5 identical 10-litre jars namely A, B, C, D and E. The seeds in each jar are exposed to the conditions as shown in the table below.

Jar A	Jar B	Jar C	Jar D	Jar E
• Sealed	• Sealed	• Open	• Open	• Open
• Damp cotton wool	• Damp cotton wool	• Damp cotton wool	• Damp cotton wool	• Dry cotton wool
• Placed in the garden	• Placed in the garden	• Placed in the freezer	• Placed in the cardboard	• Placed in the garden
• Contained substance to absorb carbon dioxide	• Contained substance to absorb oxygen			

In which of the jars would the seeds most likely to germinate?

- (1) A and D only
- (2) B and D only
- (3) A, C and D only
- (4) B, C and E only

5. Ramah conducted an experiment in an enclosed hall, using identical specimen X, Y and Z of the same type and size. He attached a 5-g plasticine to X and a 20-g plasticine to Y as shown in the diagrams below.

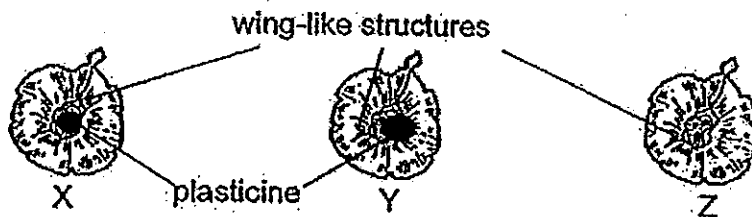

Ramah dropped each specimen, one at a time, from a fixed height above the ground and recorded the distance, d (cm), travelled by each specimen, as shown in the diagram below.

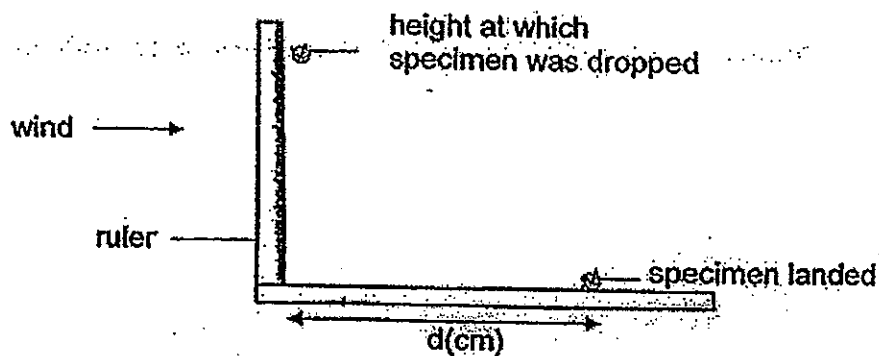

Which one of the following most likely shows Ramah's results?

Distance moved by specimen, d (cm)			
	X	Y	Z
(1)	23.9	56.7	89.0
(2)	56.7	23.9	89.0
(3)	56.7	89.0	23.9
(4)	89.0	56.7	23.9

6. The diagram below shows the flower of plant X and insect Y.

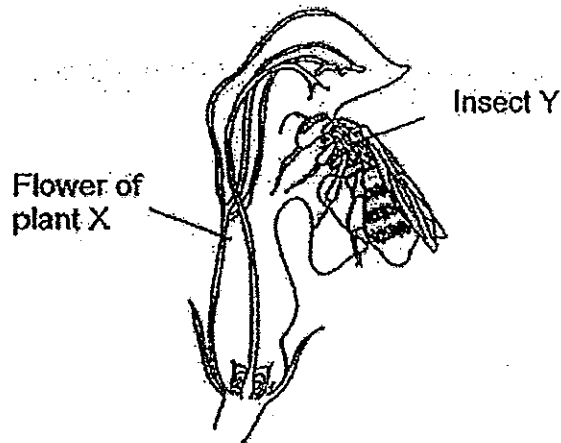

Which one of the following statements best describes the relationship between plant X and insect Y?

- (1) Plant X helps insect Y to hide from its prey.
- (2) Insect Y depends on plant X to find its mate.
- (3) Insect Y helps plant X to pollinate its flowers.
- (4) Plant X depends on insect Y to produce its nectar.

7. Alexis observed a seed which developed into a seedling over 8 days to compare the mass of its seed leaves, as shown in the diagram below.

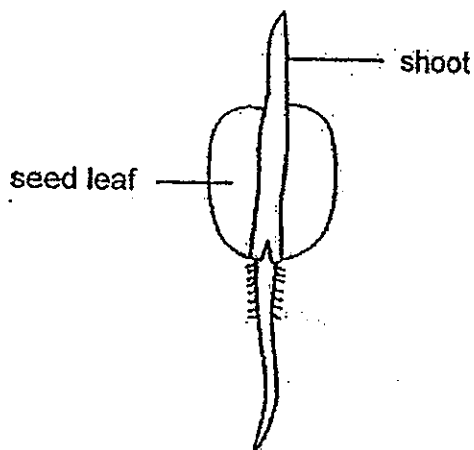

Which one of the following graphs best represents the results of her experiment?

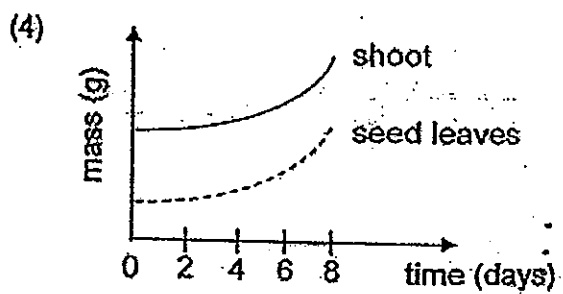
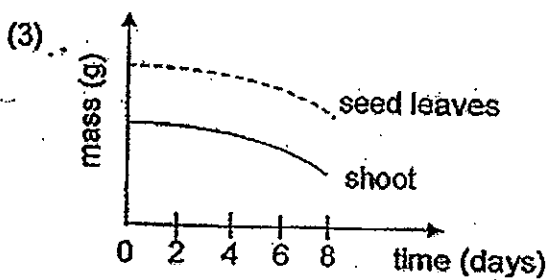
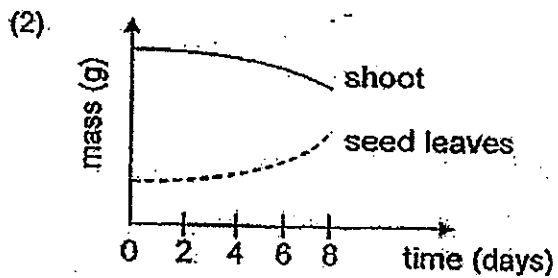
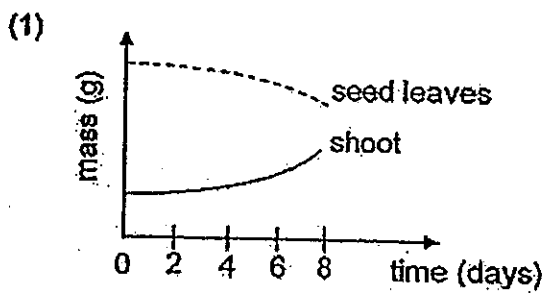

8. The diagram below shows parts of the digestive system, labeled A, B, C and D.

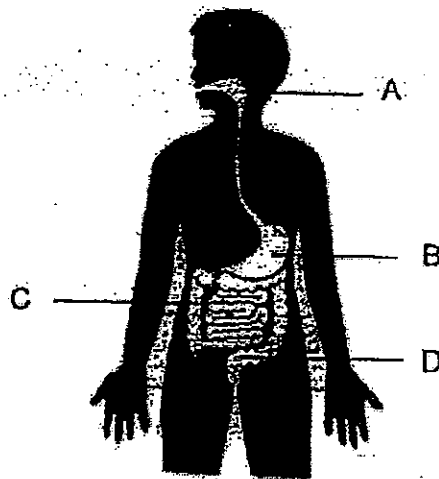

A man ate fish porridge at 6 am on an empty stomach.

Which one of the following graphs most likely shows the correct amount of undigested food left in each part of his digestive system at 11 am?

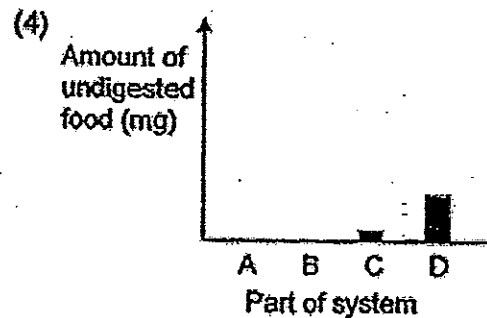
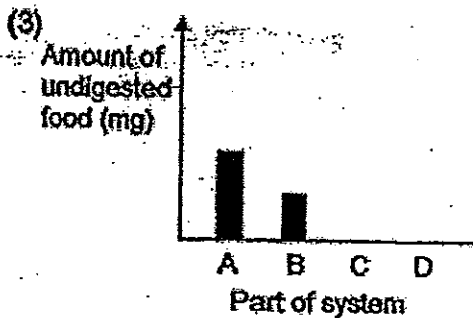
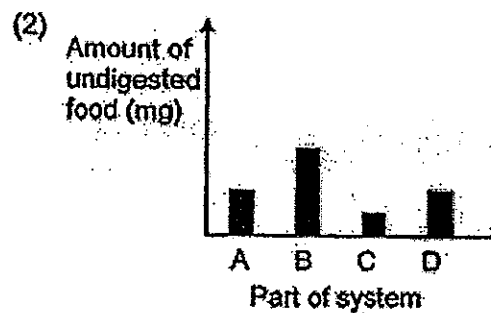
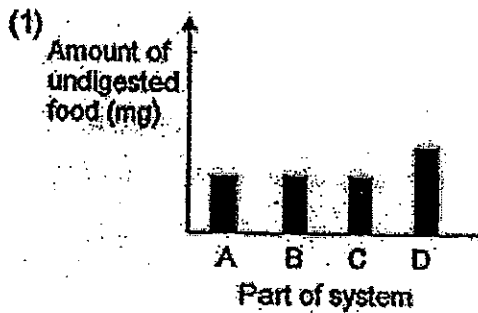

3. The chart below shows how some substances are transported in the human body.

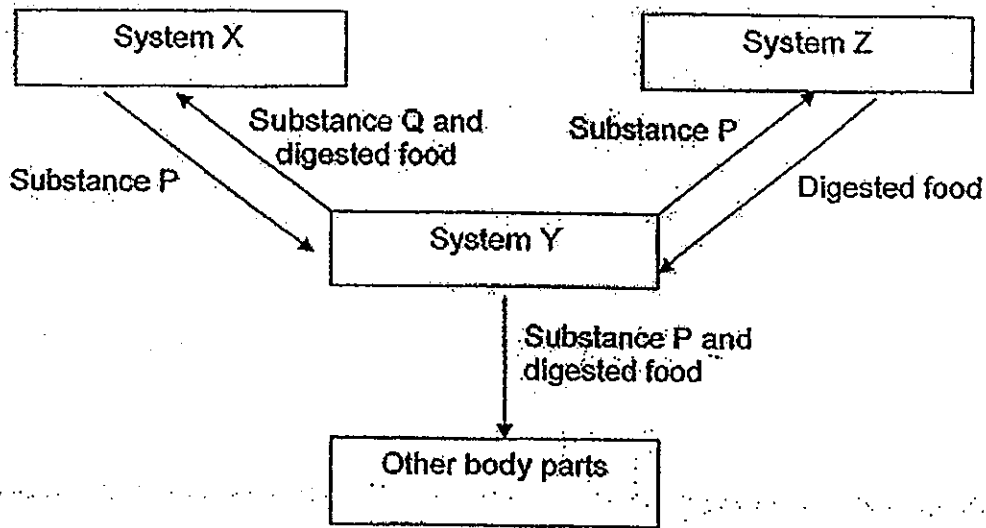

Which one of the following correctly identifies substances P and Q, and systems X, Y and Z?

	Substance P	Substance Q	System X	System Y	System Z
(1)	Carbon dioxide	Oxygen	Circulatory system	Digestive system	Respiratory system
(2)	Carbon dioxide	Oxygen	Digestive system	Circulatory system	Respiratory system
(3)	Oxygen	Carbon dioxide	Digestive system	Respiratory system	Circulatory system
(4)	Oxygen	Carbon dioxide	Respiratory system	Circulatory system	Digestive system

10. Harry wanted to investigate how the light intensity affects the rate of photosynthesis of the fully-submerged aquatic plant, Elodea. He placed two Elodea in each of the three measuring cylinders containing identical amount of water as shown in the diagrams below. The set-ups were placed in a pitch dark room.

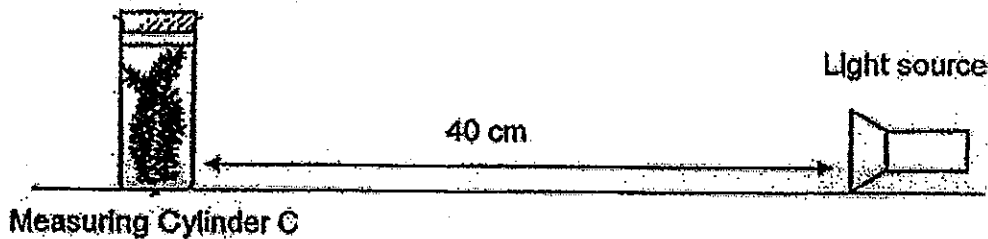
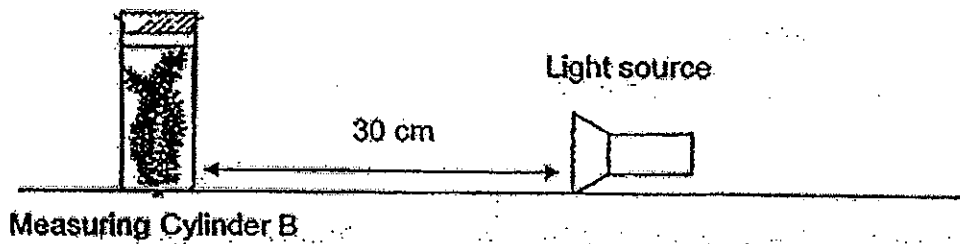
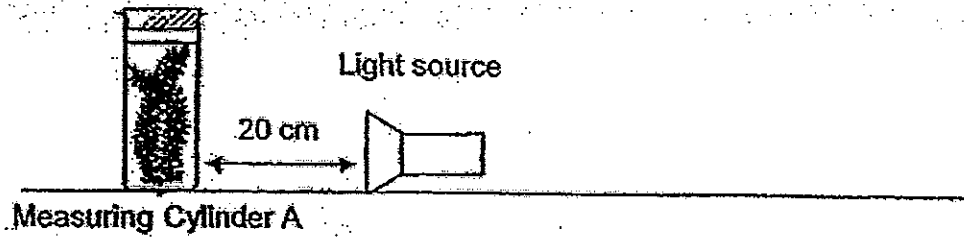

The table below shows four sets of results, W, X, Y and Z.

Distance of plant from light source (cm)	Number of bubbles counted			
	W	X	Y	Z
20	10	20	40	40
30	20	20	20	10
40	40	40	10	20

Which of the following is most likely to be the set of results collected by Harry?

- (1) W
- (2) X
- (3) Y
- (4) Z

11. The diagrams below show three different types of cells, P, Q and R.

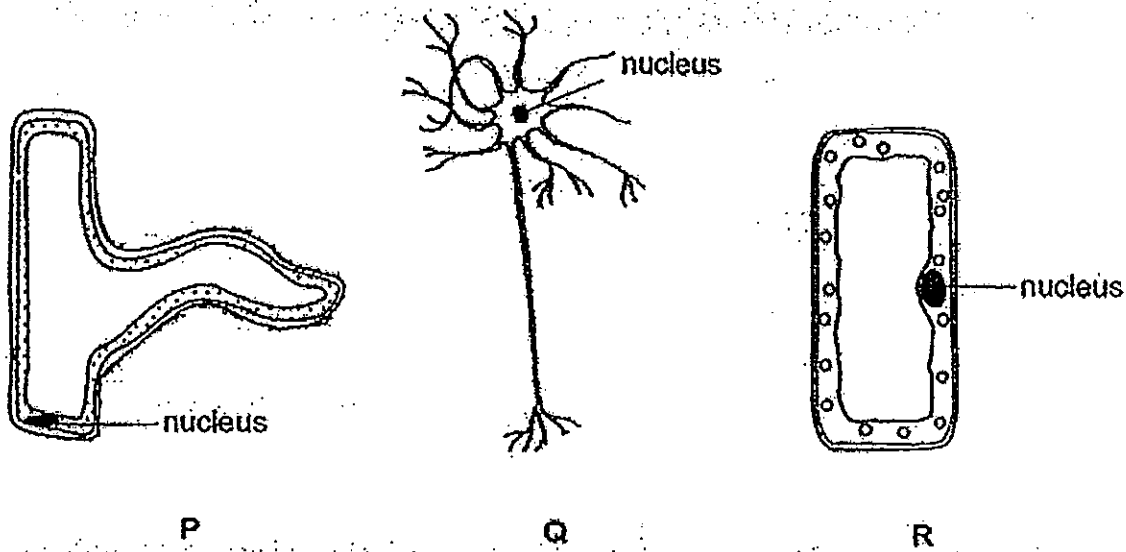

Which of the following statements are most likely true?

- A Only Q is found in animals.
- B All the cells are found in plants.
- C Only R is able to carry out photosynthesis.
- D Only Q and R are able to carry out cell division.

- (1) A and C
- (2) B and D
- (3) A, B and C
- (4) A, C and D

12. Due to the extensive logging activities in a forest, it causes soil erosion in the area. As a result, large quantity of soil has been washed into the nearby lake during torrential rains.

Based on the above information, which of the following statements about the effect of soil erosion on the lake is/are likely to be true?

- A The soil particles settle on the bottom of the lake will cause the lake to become increasingly shallow.
- B The amount of dissolved oxygen in the lake will decrease due to the lower rate of photosynthesis of aquatic plants.
- C The population of the fully submerged plants in the murky lake will increase due to increased light availability below the surface.

- (1) B only
- (2) C only
- (3) A and B only
- (4) A and C only

13. Nurul wanted to find out if the presence of fertilizer affects plant growth. She prepared 4 set-ups, W, X, Y and Z, using 4 similar plants. The table below shows the amount of fertilizer and water given to each set-up.

	Set-up W	Set-up X	Set-up Y	Set-up Z
Amount of fertilizer added (ml)	5 ml every four days	5 ml daily	0	0
Amount of water added daily (ml)	70	70	70	50

Which of the following set-ups should Nurul use in order to carry out a fair test?

	Set-up
(1)	W, Z
(2)	W, X
(3)	X, Y
(4)	Y, Z

14. The food web below shows the food relationships among some organisms in a pond community.

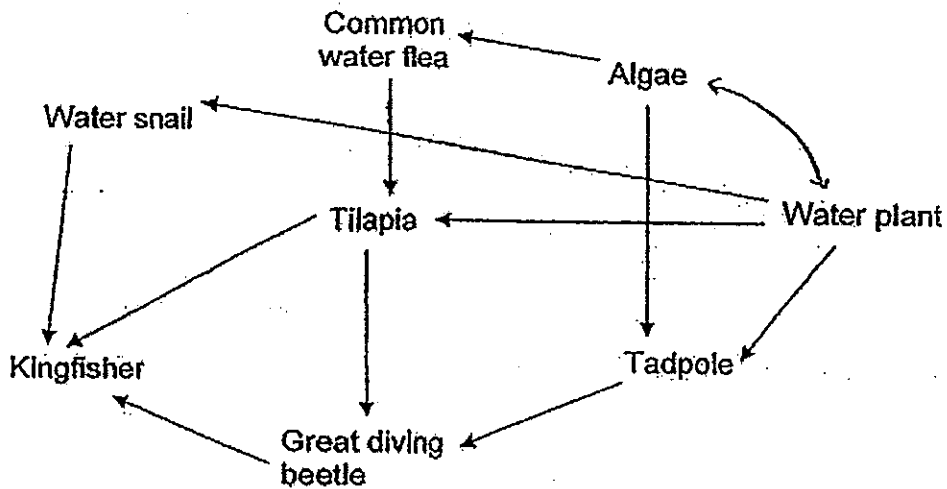

Based on the above food web, which of the following statements are true?

- A There are two omnivores.
- B There are six food chains.
- C There are three predators.
- D There are three herbivores.

- (1) A and B only
- (2) C and D only
- (3) A, B and D only
- (4) B, C and D only

15. Decomposers enrich the soil with nutrients for the plants to grow well. The diagram below shows how decomposers act on dead matter and change them into simple substances.

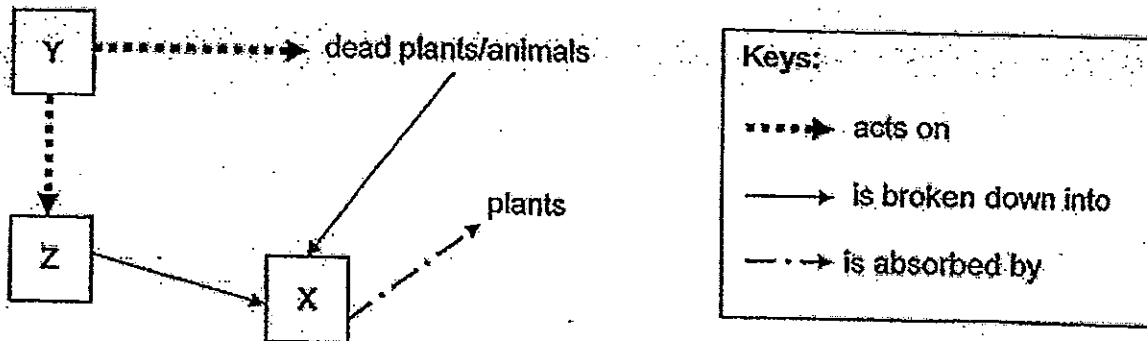

Which of the following best represent X, Y and Z respectively?

	X	Y	Z
(1)	carbon dioxide	predators	nutrients
(2)	water	fungi	nutrients
(3)	mineral salts	prey	animal waste
(4)	mineral salts	bacteria	animal waste

16. Clownfish live in groups among sea anemones as they depend on the sea anemones stinging tentacles for protection.

It is a unique species of fish due to its ability to switch sexes. In each host anemone, there is only one female breeder which will mate with the only male breeder. The rest of the clownfish are male non-breeders which are sexually immature. The size of the clownfish gets smaller as their rank decreases.

If the female breeder in the group dies, the male breeder will change sex and increase in size to become the female breeder. The largest male non-breeders will become the male breeder.

The diagram below shows the social hierarchy system of clownfish.

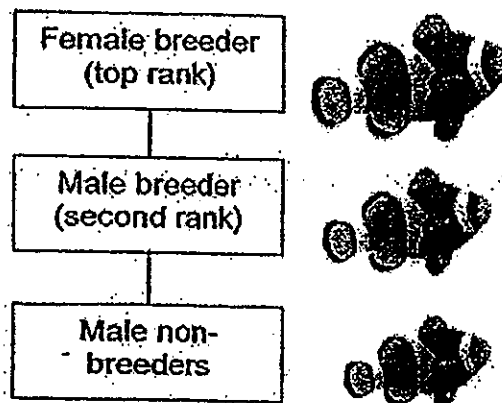

Which of the following statements are most likely true about the clownfish's ability to change sex?

- A It allows them to be protected by the sea anemones without having to move around to search for a mate.
 - B It ensures that there will always be a female breeder and a male breeder in the group to allow them to continue breeding.
 - C It ensures that any male non-breeders within the group can take over the role of the female breeder in the absence of female clownfish.
 - D It allows the male non-breeder to take over the role of the female breeder once they have grown to a larger size than the female breeder.
- (1) A and B only
(2) C and D only
(3) A, B and C only
(4) B, C and D only

17. Compost is rich black soil which is used as fertilizers by farmers. It can be produced by simply recycling waste materials and allowing them to decompose naturally and quickly.

The table below shows four groups of waste materials.

Group A	Group B	Group C	Group D
Tea leaves Egg shells Orange Peels Coffee powder	Syringes Glass bulbs Styrofoam boxes	Metal rings Leather belts Woolen socks Plastic hairclips	Paper Cotton rags Wooden toothpicks

Which of the following groups of waste materials are suitable to be used to make the compost?

- (1) A and C
 - (2) A and D
 - (3) B and C
 - (4) B and D
18. During a solar eclipse, the sky becomes dark for a short period of time during the day.

The diagram below shows the positions of the Sun, the Moon and the Earth when the solar eclipse occurs (Not drawn to scale).

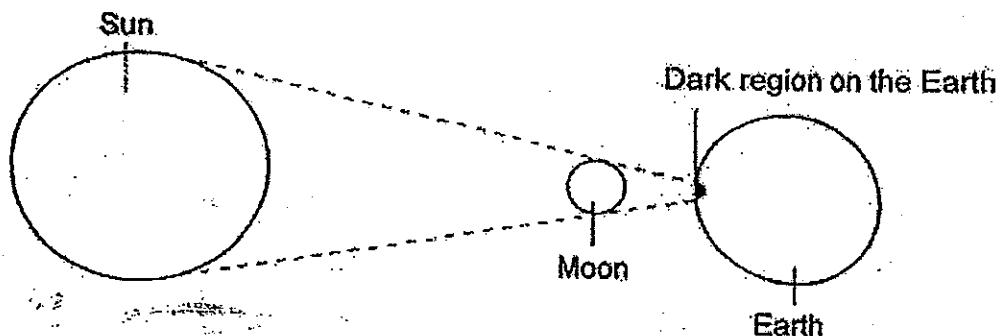

Using the information above, which one of the following statements best explains why a particular region of the Earth becomes dark when the Moon is between the Earth and the Sun?

- (1) The Moon absorbs the Sun's light.
- (2) The Sun reflects light to the Moon only.
- (3) The Earth does not allow the Sun's light to pass through.
- (4) The Moon blocks the Sun's light from reaching the Earth.

19. Jim conducted an experiment to compare the texture of four different surfaces, P, Q, R and S.

He placed a shoe on surface P and pulled it in the direction as indicated by the arrow (→) shown in the diagram below.

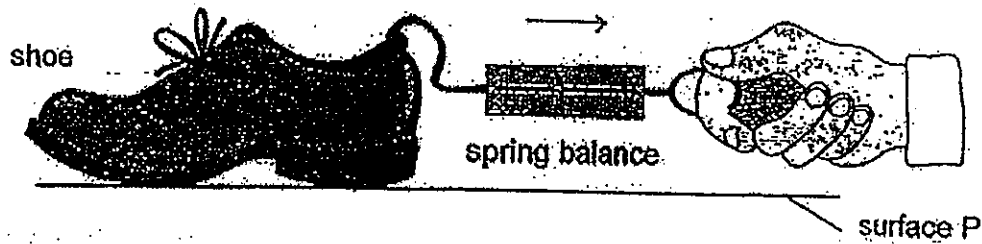

He recorded the amount of force needed to pull the shoe over a fixed distance.

Next, Jim placed the same shoe on the other surfaces, Q, R and S, one at a time and recorded his results for each type of surface. His results are shown in the table below.

Type of surfaces	Amount of force (N)
P	30
Q	60
R	15
S	90

Based on the results above, which one of the following conclusions is correct?

- (1) Surface R was the roughest and surface S was the smoothest.
- (2) Surface Q was smoother than surface R but rougher than surface S.
- (3) There was least friction between the shoe and surface R, as compared to other surfaces.
- (4) The friction between the shoe and surface P was greater than between the shoe and surface Q.

20. Raja heated a flask of water over a flame as shown below.

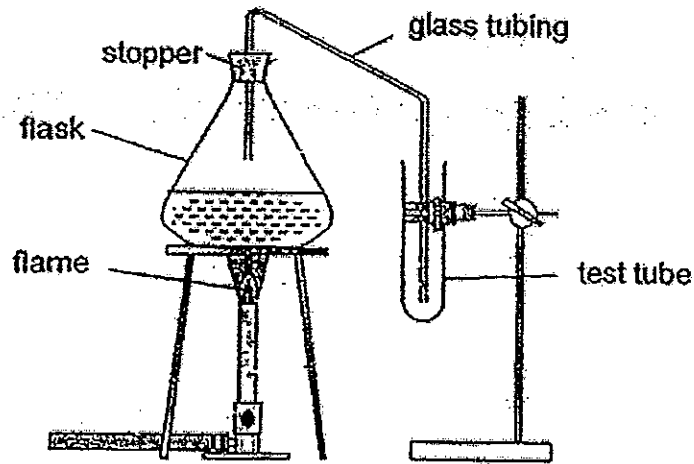

After a while, Raja observed that water droplets were formed.

Which one of these diagrams shows the parts where Raja saw these water droplets?

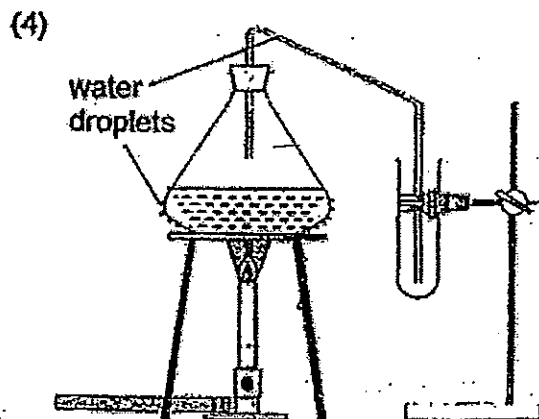
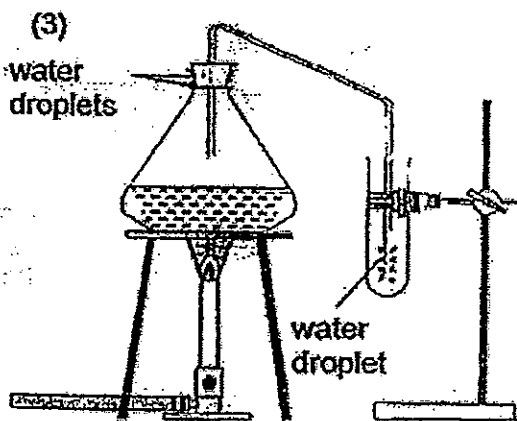
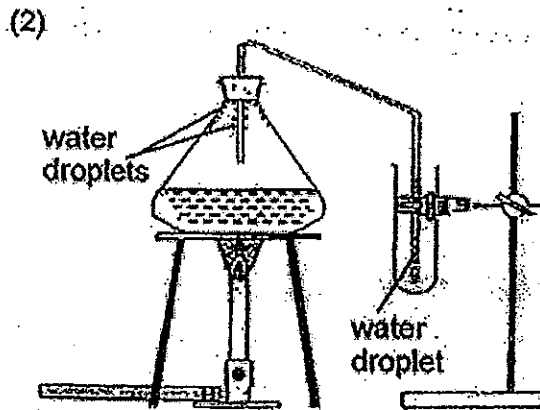
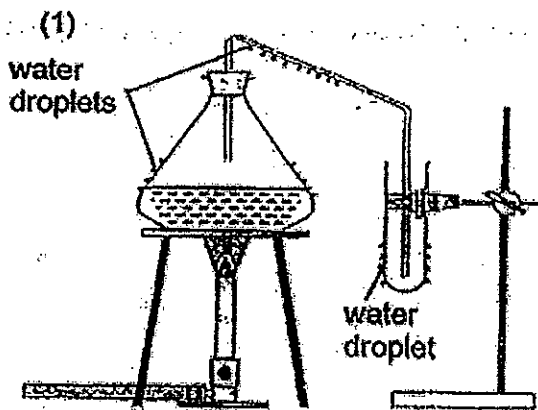

21. The diagram below shows a set-up in which water changes from one state to another.

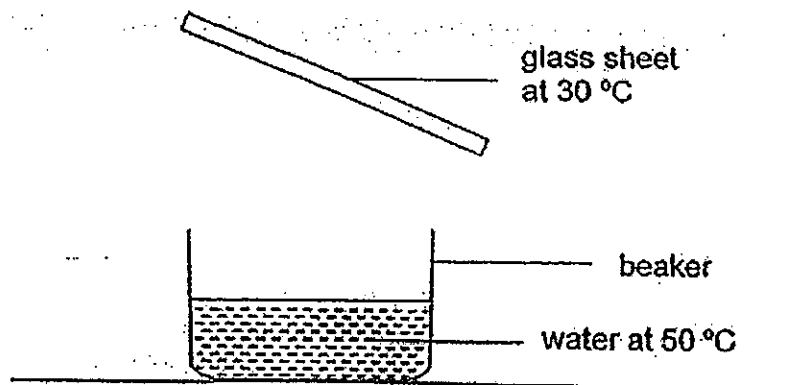

Which one of the following will most likely result in an increase in the amount of water droplets formed on the glass sheet?

- A Add ice into the water
- B Use a colder glass sheet
- C Increase temperature of water
- D Place a fan in front of the set-up

- (1) B and C only
- (2) A and D only
- (3) B, C and D only
- (4) A, B and D only

22. Betty had three rods, P, Q and R, made of different materials. She placed them in various positions, A, B and C, in the circuit shown below.

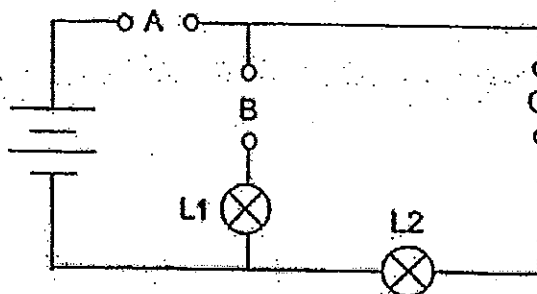

The results of the experiment were shown in the table below. A tick (✓) in the box indicates the lamp was lit up.

Positions where rods were placed			Lamp lit up	
A	B	C	L1	L2
P	Q	R		
Q	R	P	✓	
R	P	Q		✓

Which one of the following statements is most likely to be true?

- (1) Only rod Q is a conductor of electricity.
- (2) Only rods Q and R are conductors of electricity.
- (3) Only rods P and R are non-conductors of electricity.
- (4) Only rods P and Q are non-conductors of electricity.

- 23 The diagram below shows a circuit arrangement with identical dry cells, switches and bulbs.

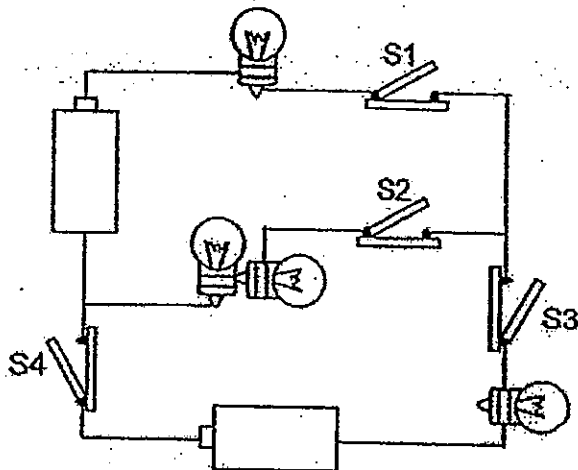

Which of the following switches must be closed to light up at least three bulbs?

- (1) S1 and S2 only
 - (2) S2 and S3 only
 - (3) S1, S3 and S4 only
 - (4) S2, S3 and S4 only
24. Sally set up the following experiment. Point Y of the plank was in contact with the edge of the block, as shown in the diagram below. When she released the ball, it travelled down the ramp but was unable to hit the container.

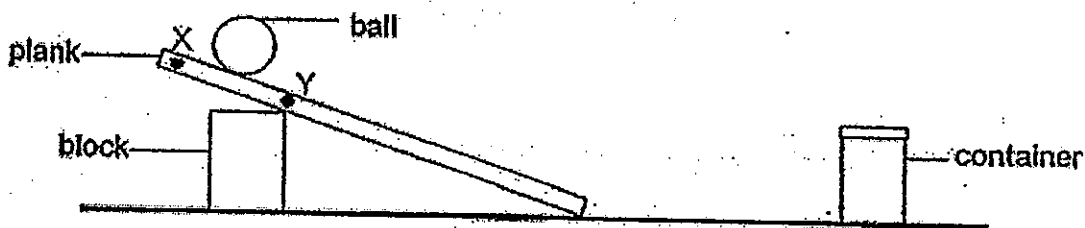

Which of the following would most likely allow the ball to travel further in order to hit the container?

- A Apply oil on the ball.
- B Wrap the plank with sandpaper.
- C Exert a push on the ball when releasing it.
- D Shift the block such that point X of the plank is resting on the block.

- (1) B only
- (2) B and C only
- (3) A and C only
- (4) A, C and D only

25. Two forces, F_1 and F_2 , were exerted on Block A at the same time, as shown in the diagram below. When F_2 is greater than F_1 , Block A moves towards point X.

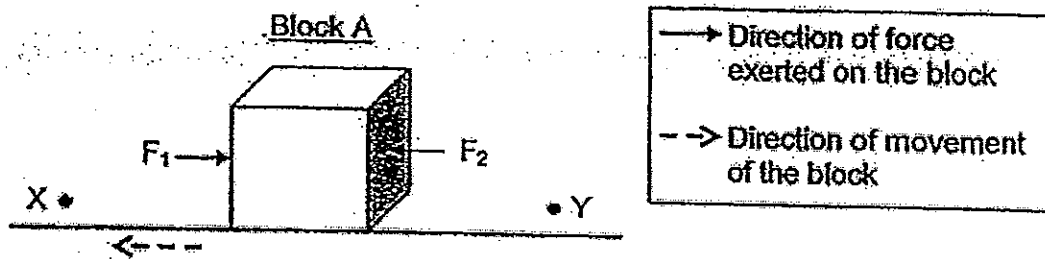

Forces, F_3 to F_6 , were exerted on two other identical blocks at the same time, as shown in the diagrams below.

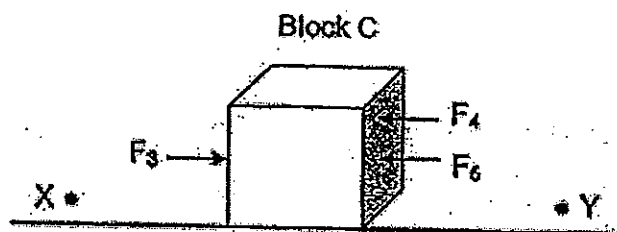
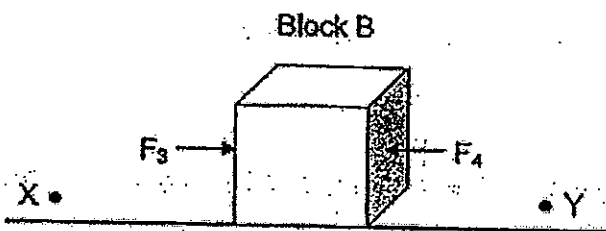

Which one of the following shows the correct amount of forces, F_3 , F_4 and F_6 , exerted on each block such that Block B will move towards point Y while Block C will remain stationary?

	F_3 (N)	F_4 (N)	F_6 (N)
(1)	10	30	20
(2)	20	10	20
(3)	20	20	10
(4)	30	10	20

26. A magnet was placed on a steel table top. A push was exerted on the magnet to move it horizontally across the table from point A to point B as shown in the diagram below.

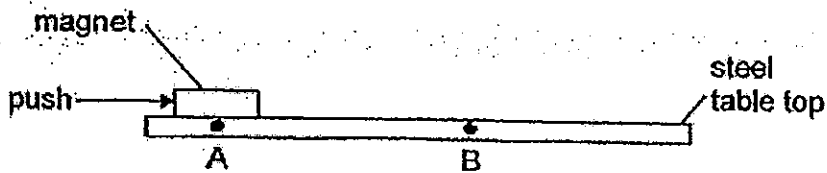

Which of the following force(s) must the push overcome such that the magnet moved from point A to point B?

- (1) Frictional force only
 - (2) Gravitational force only
 - (3) Frictional force and magnetic force only
 - (4) Frictional force, magnetic force and gravitational force
27. When Ian placed an object between the light source and the white screen, a shadow of the object was cast on the white screen as shown below.

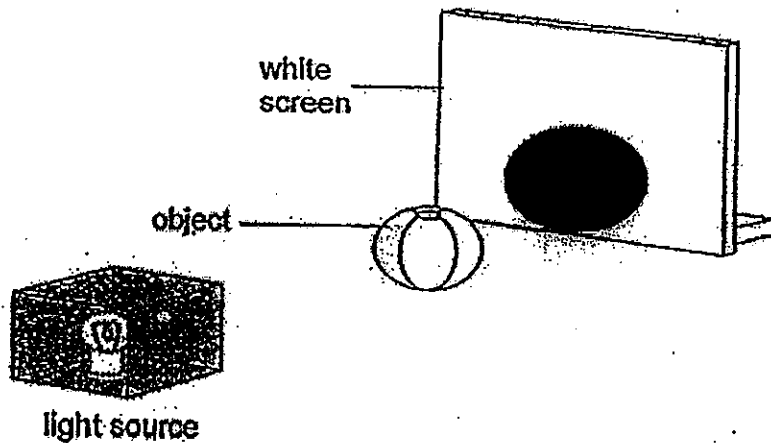

Which of the following changes should Ian make to the set-up such that he could observe a bigger shadow of the object?

- A Use a brighter light source.
- B Move the screen further from the object.
- C Move the light source nearer to the object.
- D Move the light source further from the object.

- (1) A and D only
- (2) B and C only
- (3) A, B and D only
- (4) B, C and D only

28. Cindy had 4 different bimetallic strips, A, B, C and D, of the same length. Each bimetallic strip was made up of two different metals joined together.

Cindy heated each strip, A, B, C and D, with the same amount of heat for the same period of time. She recorded her observations as shown in the diagrams below.

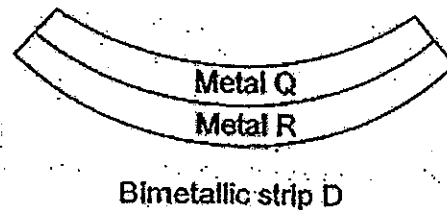
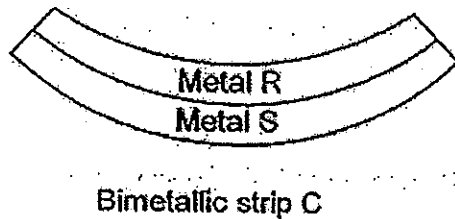
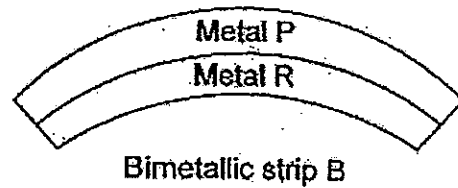
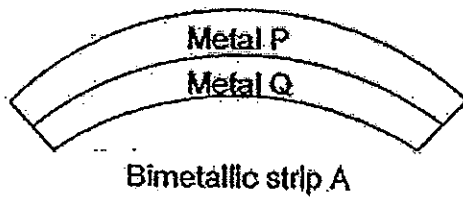

Based on the information above, which of the following shows the correct arrangement of the metals, P, Q, R and S, in order of increasing rate of expansion?

	least				greatest
(1)	P	R	Q	S	
(2)	Q	R	S	P	
(3)	S	Q	R	P	
(4)	S	P	R	Q	

29. The diagram below shows a steel bridge.

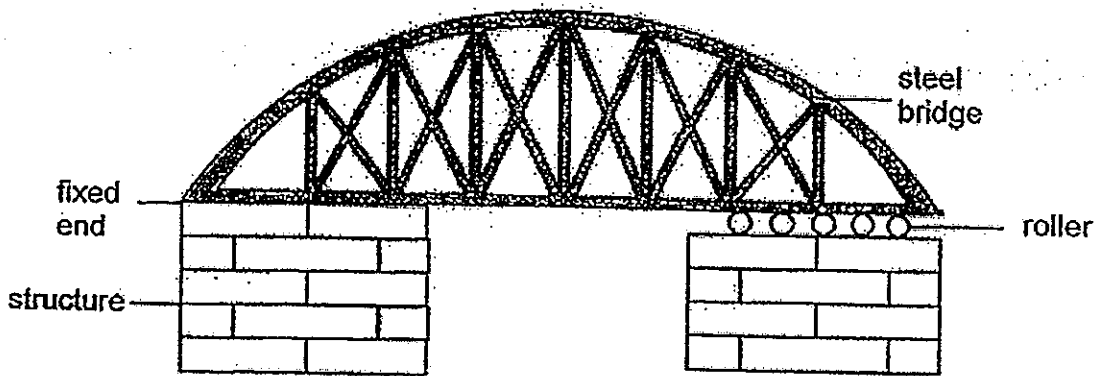

One end of the bridge is fixed securely to the structure unlike the other end which is resting on rollers as shown above.

Which of the following statement(s) explain(s) why one end of the bridge is resting on the rollers?

- A To reduce friction between the structure and the bridge.
- B To allow the bridge to expand on hot days without damaging the structure.
- C To allow the rollers to contract on cold days without damaging the structure.

- (1) B only
- (2) A and B only
- (3) B and C only
- (4) A and C only

30. The diagram below shows Mr Wong playing bowling.

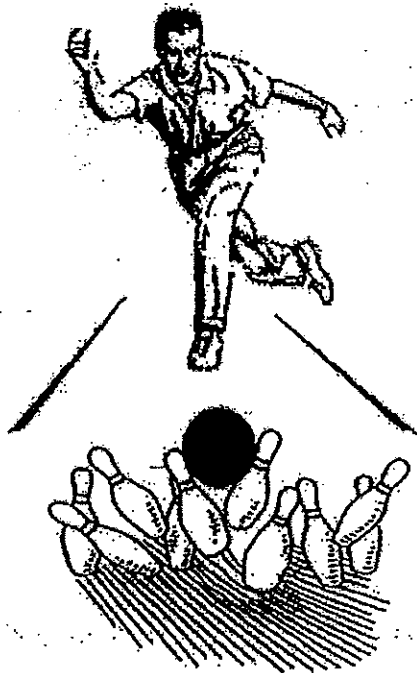

Which one of the following best shows the energy conversions when the bowling ball rolls and hits the pins?

(1)	kinetic energy (bowling ball)	→	heat energy (pins)	→	kinetic energy (pins)		
(2)	gravitational potential energy (man)	→	kinetic energy (bowling ball)	→	sound energy + heat energy (pins)		
(3)	kinetic energy (bowling ball)	→	kinetic energy + sound energy + heat energy (pins)				
(4)	chemical potential energy (bowling ball)	→	gravitational potential energy (man)	→	kinetic energy (bowling ball)	→	sound energy + heat energy (pins)

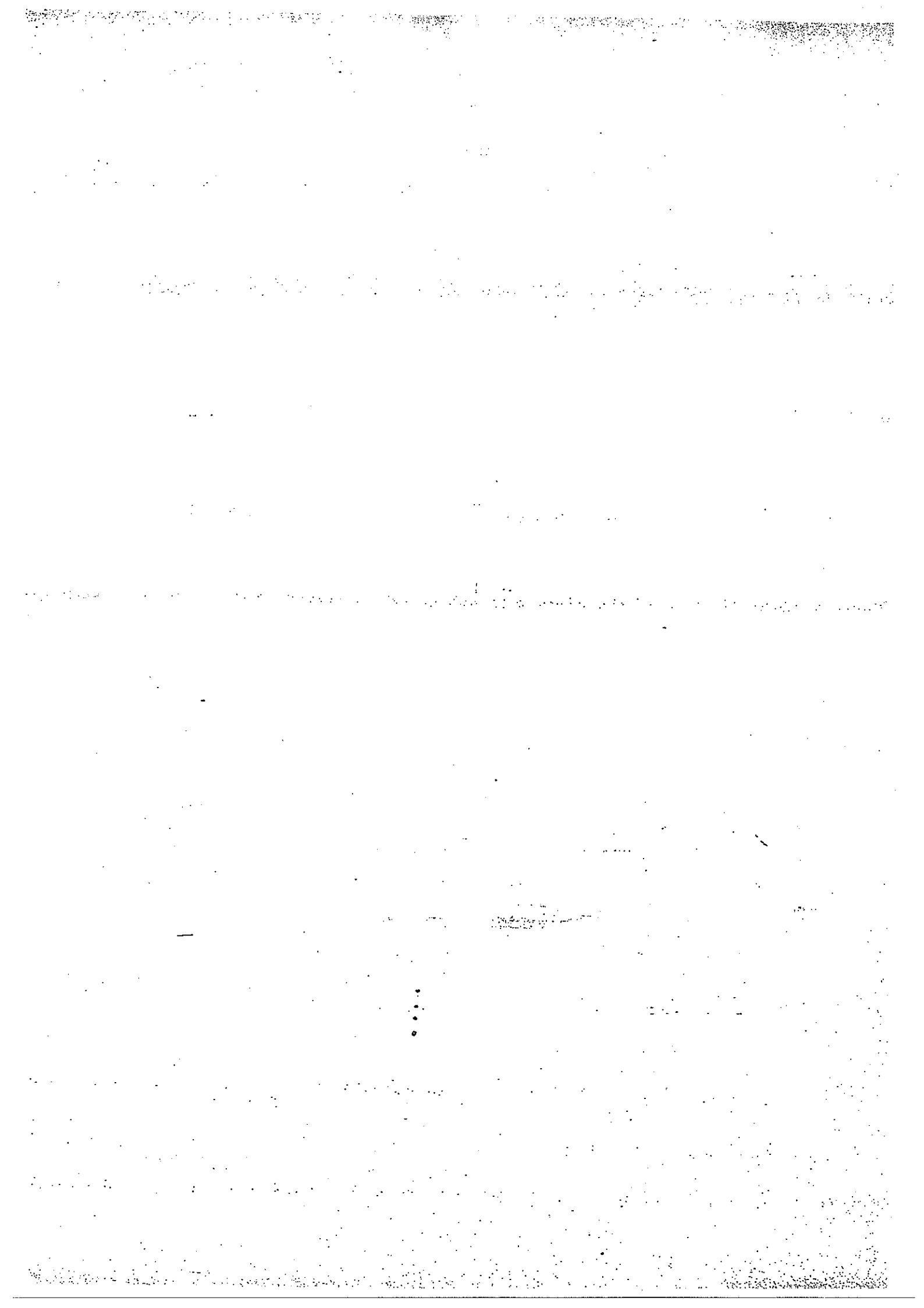

Name : _____ Index No : _____ Class : P6 _____

40

SECTION B (40 marks)

For questions 31 to 44, write your answers clearly in the spaces provided. The number of marks available is shown in the brackets [] at the end of each question or part question.

31. The table below shows the flowering months for plants A, B, C and D.

Plant	Flowering begins in	Number of flowering months
A	May	6
B	February	?
C	April	2
D	June	2

The following is a graphic representation of the data above.

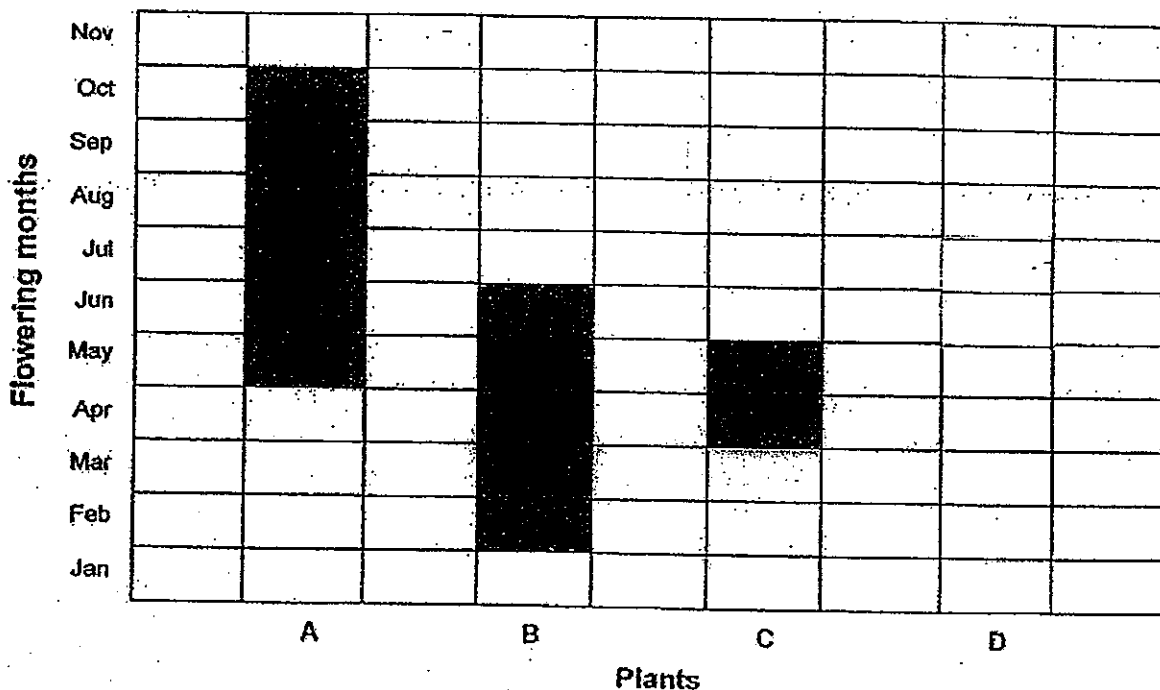

(a) Based on the information above, for how many months did Plant B flower? [1]

(b) Use the data in the table above, complete the graph for Plant D by shading the appropriate box(es) in the above graph. [1]

Score 2

32. Hannah placed 5 identical pots of seedlings, A, B, C, D and E in the field and watered them with different amount of water. She recorded the daily average increase in height of each seedlings at the end of one week as shown in the table below.

Pot	Amount of water given daily (ml)	Daily average increase in height of seedlings (cm)
A	25	2.0
B	30	2.5
C	50	3.0
D	65	4.0
E	95	4.0

- (a) Based on the information above, how did the amount of water given to the seedlings daily affect their growth? [1]

- (b) For the seedlings to grow well, their average increase in height have to be at least 4.0 cm in one week. From the table above, suggest the least amount of water to give to the seedlings per day to ensure that they grow well. [1]

Score	2
-------	---

33. The diagram below shows a plant.

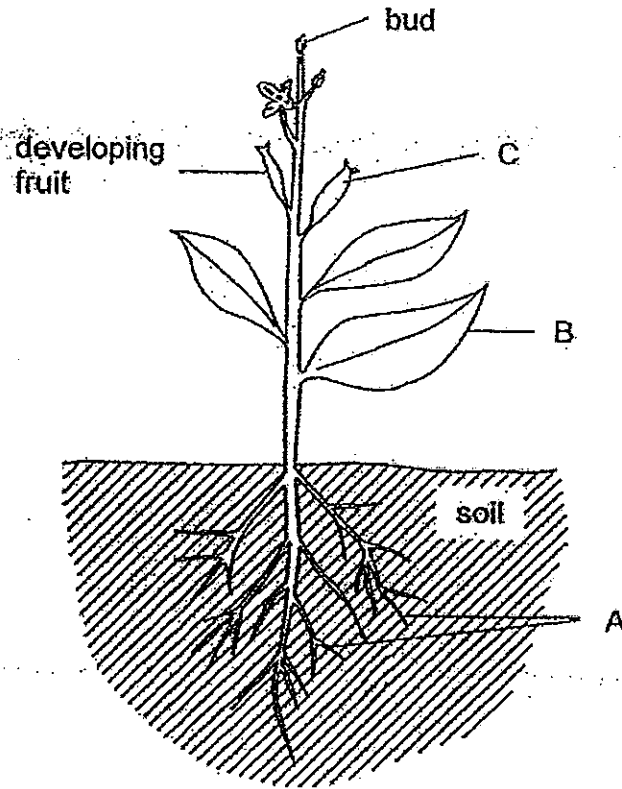

(a) Identify the substances that were transported from A to B and from B to C. [1]

(i) A to B : _____

(ii) B to C : _____

(b) Besides transporting substances, suggest another function of the roots. [1]

Score	2
-------	---

34. The diagram below shows four different layers of a typical rainforest.

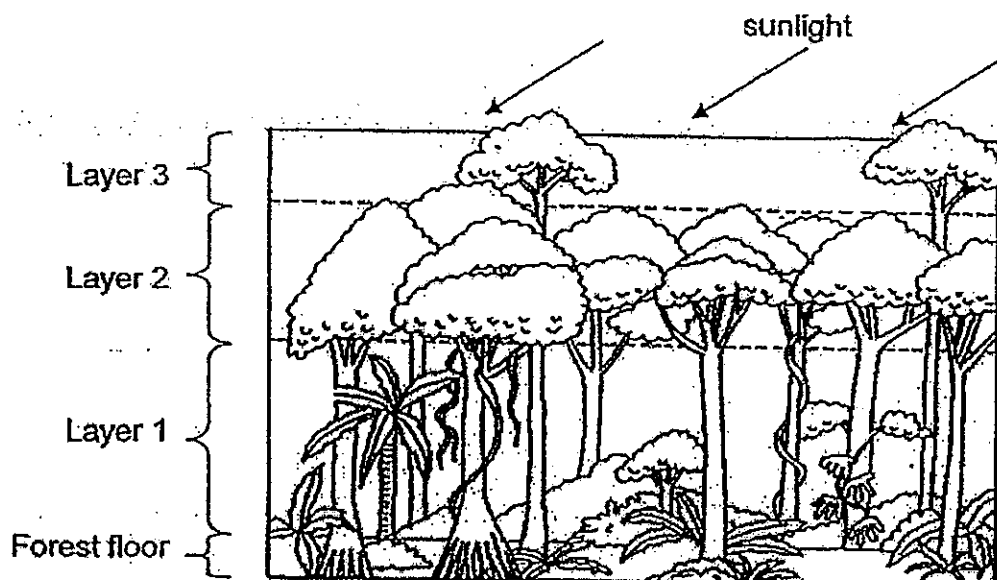

Ivan went trekking in a rainforest and he observed that there are fewer plants found on the forest floor than the upper layers, 1, 2 and 3.

Based on the information above, explain Ivan's observations.

[2]

Score	2
-------	---

35. Kelvin wants to investigate the effect of pollutant X on the survival of aquatic plant A using all the materials provided in the table below.

- | |
|--|
| <ul style="list-style-type: none"> • 10 similar aquatic plant A • 1 dropper • 2 identical beakers • 1 container containing 400 ml of pond water • 1 bottle containing pollutant X |
|--|

(a) Write down the steps that Kelvin should carry out in his experiment. [3]

Step	Procedure
1	

(b) Describe what Kelvin would observe in order to conclude that Pollutant X has a harmful effect on the aquatic plant. [1]

.....

.....

.....

Score	4
-------	---

36. The classification chart below shows how the beaks of four species of birds and their diet are grouped.

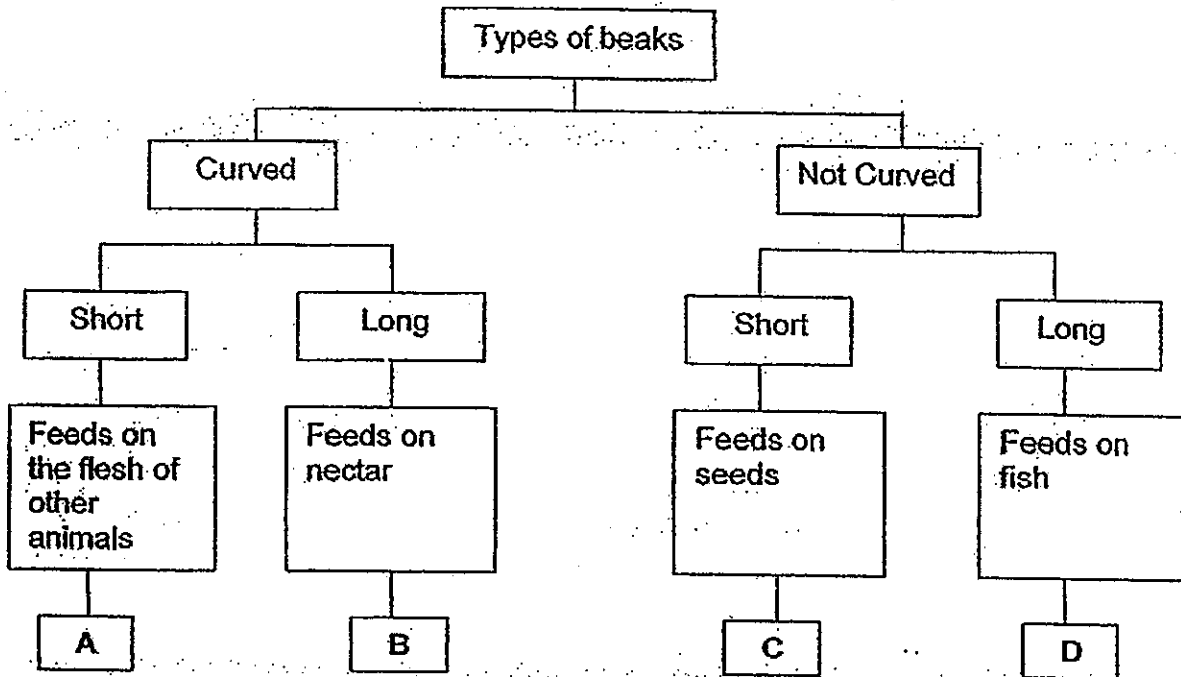

(a) Based on the information provided above, writing the letters (A to D) in the correct boxes to match each beak shown in the diagrams below. [2]

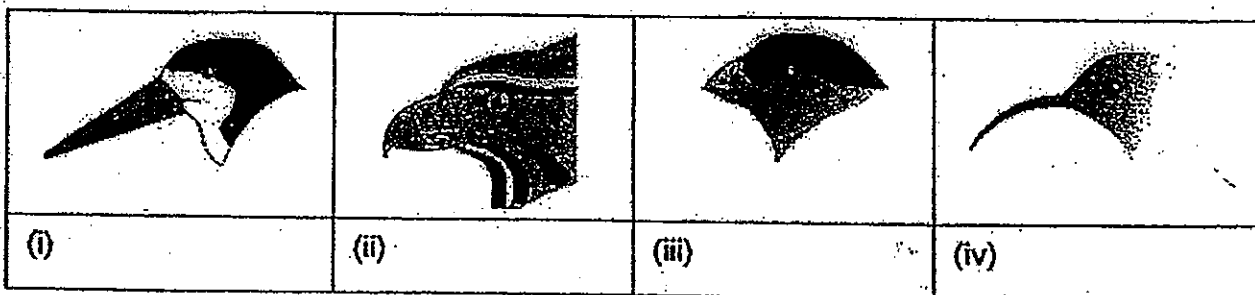

Score	2
-------	---

The diagrams below show the nests built by Bird X and Y.



Nest of Bird X



Nest of Bird Y

- (b) Based on the diagrams above, which bird has built a nest that benefits its young during rainy seasons? Explain your answer. [1]

- (c) Predatory birds possess keen eyesight to spot prey on the ground while flying from a great height.

Why is the structure of the nest of Bird Y a disadvantage compared to the nest of Bird X in the presence of predatory birds? Explain your answer. [1]

Score	2
-------	---

37. Ravi had three containers of the same size, colour and thickness, each made of different materials, R, S and T.

He filled all the containers with equal amount of water and left them in a room with a constant temperature of 35 °C for 3 days. After 3 days, Ravi observed that the water level in each container decreased as shown in the diagram below.

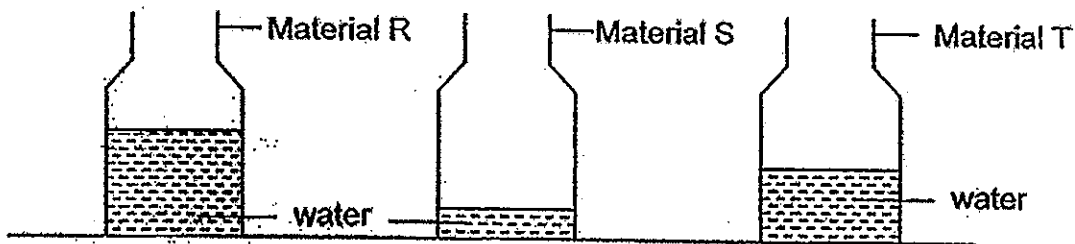

(a) Based on the observations above, what can you infer about the properties of materials, R, S and T? [1]

(b) Ravi repeated the experiment by placing the containers in an air-conditioned room at a temperature of 20 °C for 3 days. Would there be any difference in the change of water level in the three containers compared to the earlier experiment? Explain your answer. [2]

Score	3
-------	---

38. Hamidah had two identical jars, X and Y. Some ice cubes were put into jar Y. Each jar was sealed tightly with identical plastic sheet and then placed on a weighing scale as shown in the diagrams below.

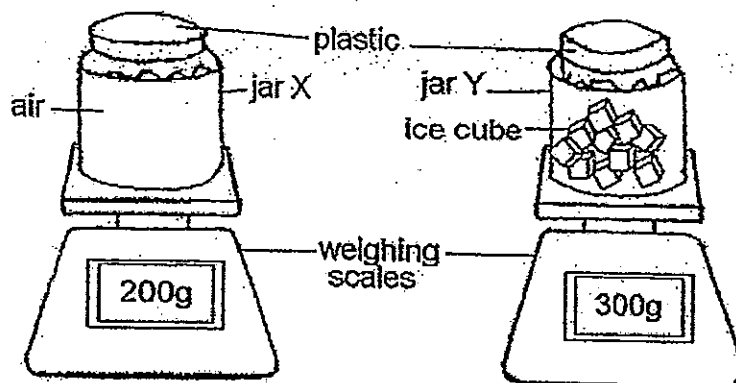

Next, Jar X was heated while jar Y was left in a room. After 15 minutes, each jar was placed on the weighing scale again.

- (a) Would Hamidah observe an increase, a decrease or no change in the mass of each jar? [1]

(i) Mass of Jar X : _____

(ii) Mass of Jar Y : _____

- (b) Explain your answer in (a) for Jar Y. [2]

Score	3
-------	---

39. Mandy set up a circuit tester and a circuit card as shown in the diagrams below.

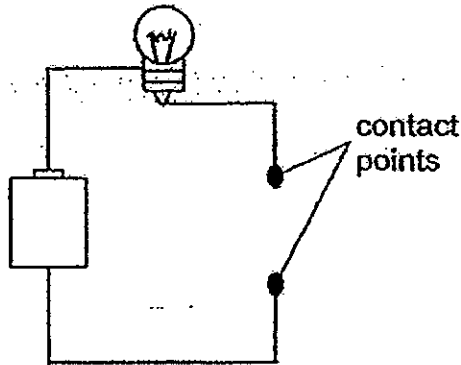

Circuit tester

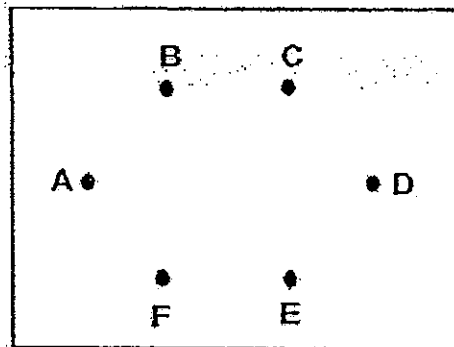

Circuit card

The circuit tester is used to test the circuit card. The circuit card has a metal thumbtack at each point, A, B, C, D, E and F. The thumbtacks are connected by wires behind the card.

The results are recorded in the table below.

Contact points of circuit tester connected to thumbtacks at	Did the bulb light up?
A and B	Yes
B and F	Yes
C and D	No
C and F	Yes
D and E	Yes

(a) Draw lines in the circuit cards below to show two possible ways of connecting the thumbtacks to achieve the results as shown in the table above. [2]

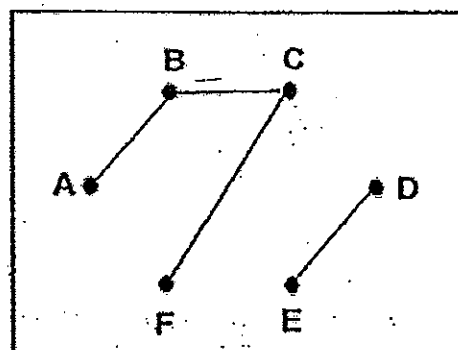
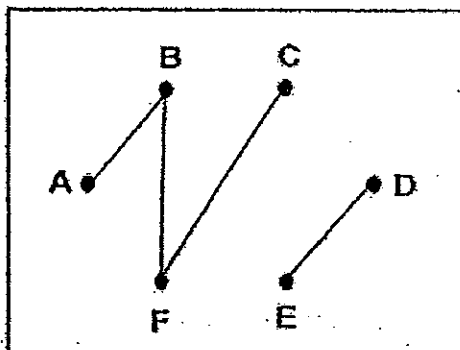

Score	2
-------	---

In a dark room, Mandy conducted another experiment in which different number of dry cells was added in a series arrangement to the same circuit tester. When the circuit is closed, the brightness of the bulb was measured using a light sensor attached to a datalogger.

(b) Predict the results of her second experiment and complete the table below.

[1]

Number of batteries	Brightness of the bulb (units)
1	
2	800
3	0
4	

Score	1
-------	---

40. Sophia had four rods, P, Q, R and S, each made of different materials. She wanted to investigate the magnetic strength of each rod using the following set-up.

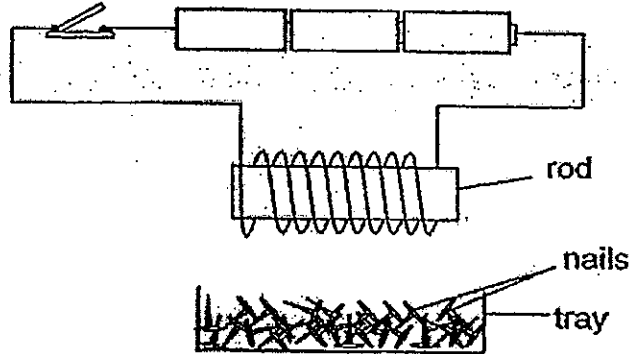

When the switch was opened, the number of nails in the tray was 60. When the switch was closed, the rod attracted some of the iron nails. The number of nails left in the tray was recorded in the table below.

Rod	Number of nails left in the tray
P	36
Q	30
R	33
S	23

- (a) Based on the table above, which rod was the strongest electromagnet when the switch was closed? Explain your answer. [1]

- (b) Identify a variable that should be kept constant in order to ensure a fair test was carried out. [1]

- (c) When Sophia replaced the rod with rod, T, she observed that the number of nails left in the tray was 60. Based on this observation, what can you infer about the property of rod T? [1]

Score	3
-------	---

41. Mirah prepared the set-up below to move the balloon and the straw from wall A to wall B. In the set-up, she passed a wire through a straw, which had a balloon attached firmly to it.

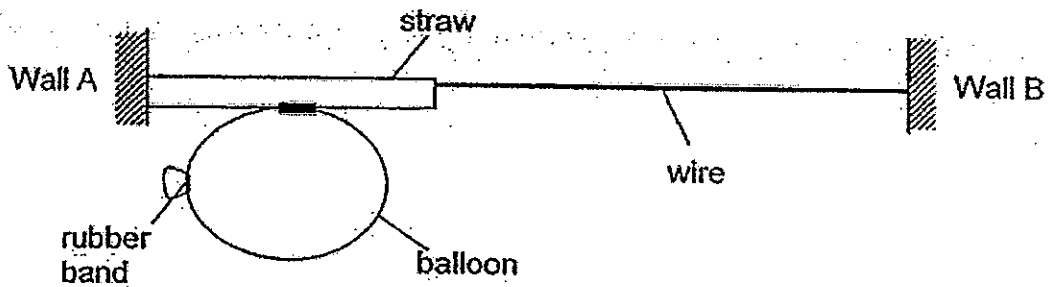

- (a) When the rubber band was removed, air rushed out of the balloon. However, she observed that the balloon and the straw remained stationary. Explain this observation using concepts on forces. [1]

- (b) Without changing the materials in the set-up, suggest what can be done to move the balloon and the straw to wall B when the rubber band was removed. [1]

Score	2
-------	---

42. Betty prepared the set-up as shown below. She observed that the cup started to spin after a while.

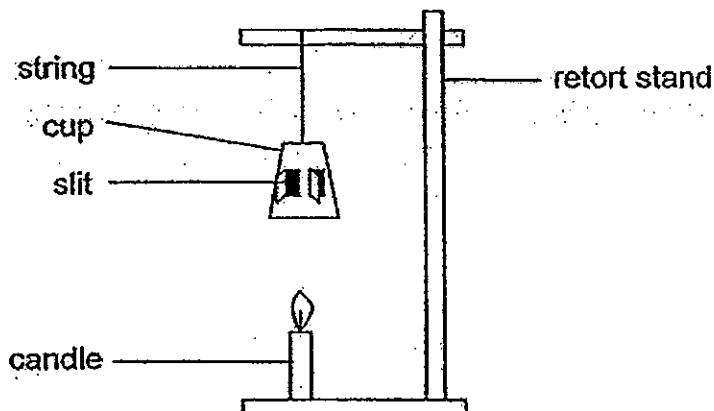

- (a) State the main energy change in the set-up above.

[1]

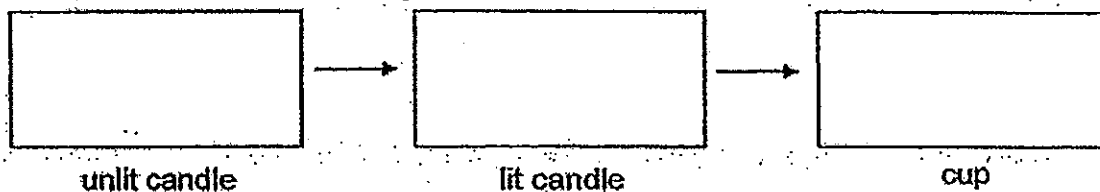

Betty repeated the experiment using strings of different lengths. She measured the number of times the cup spun per minute. She presented her results in the graph shown below.

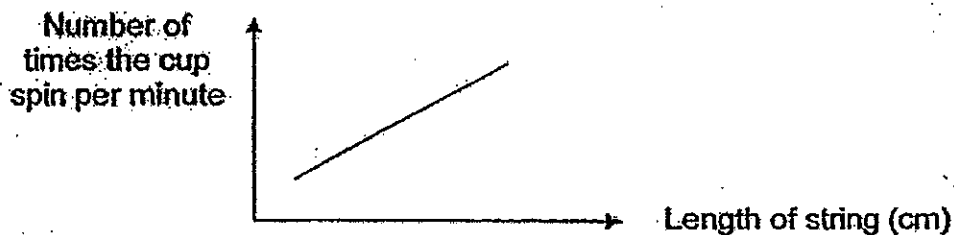

- (b) What is the relationship between the spinning rate of the cup and the distance between the candle flame and the cup? [1]

Score	2
-------	---

- (c) Betty observed that the cup spun at a different rate when she used two candles instead of one candle. Explain her observation. [2]

43. Tom wanted to investigate how the amount of water affects the time taken for it to boil.

Tom prepared three set-ups, X, Y and Z, as shown in the diagram below. The flask in each set-up was filled with a different amount of water at identical temperature before same amount of heat was applied to each of the flask.

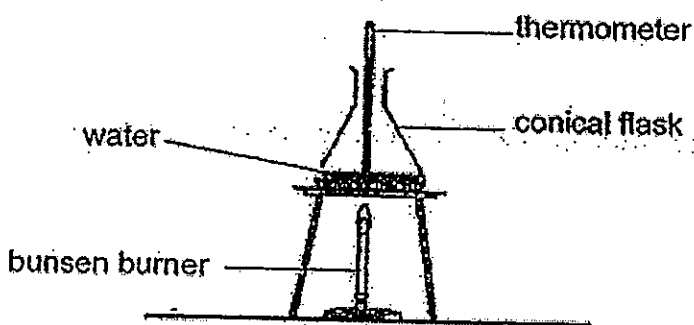

He recorded his results in a table shown below.

Set-up	Time taken for the water to boil (min)
X	13
Y	17
Z	15

- Which set-up, X, Y or Z, had the greatest amount of water at the beginning of the experiment? Explain your answer. [2]

Score	4
-------	---

44. The diagram below shows set-up X which consists of a metal bob attached to a string hung from a support.

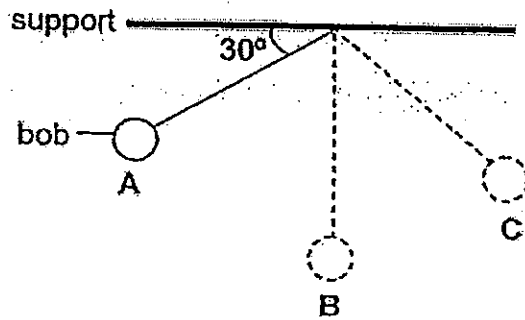

Set-up X.

When the metal bob is released from point A, it swings to point B and then to point C.

- (a) At which point, A, B or C, does the metal bob possess the most amount of gravitational potential energy? Give a reason for your answer. [1]

- (b) Give a reason why the metal bob is unable to move back to the same height at point A after the first swing. [1]

Score	2
-------	---

The diagram below shows another identical set-up, Y. The metal bob is released at position, D.

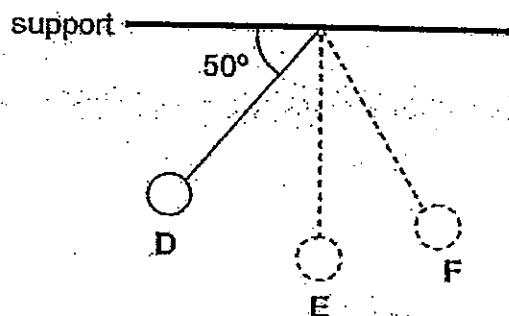

Set-up Y

- (c) In which set-up, X or Y, would the metal bob possess a greater amount of kinetic energy at the lowest point of the swing, point B or point E, respectively? Explain your answer. [2]

- END OF PAPER -

Setters : Ms Lee Suan Khim, Mdm Lim Sok Yen, Ms Loo Ching Yee, Mrs Sharon Seah

Score	
	2

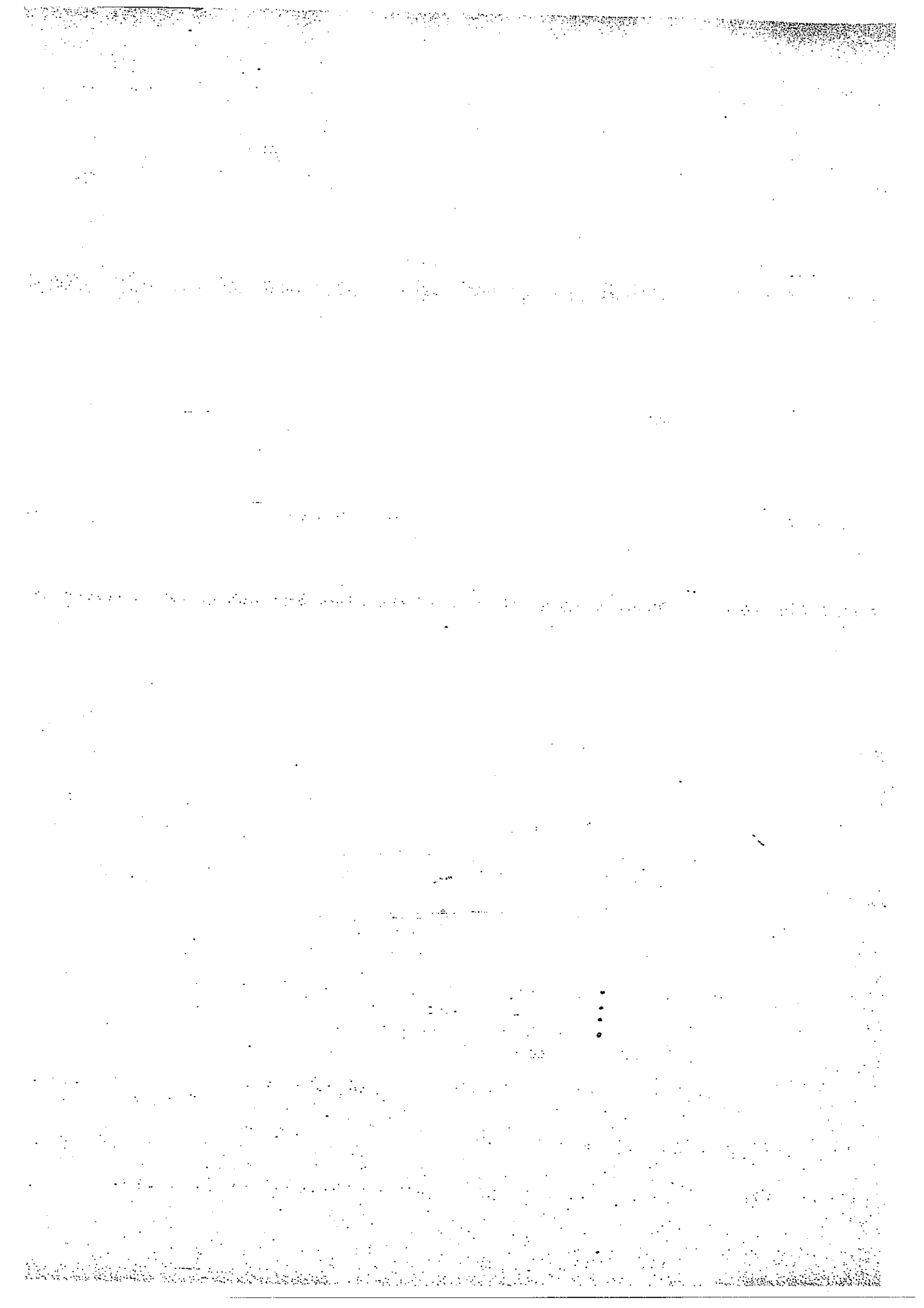

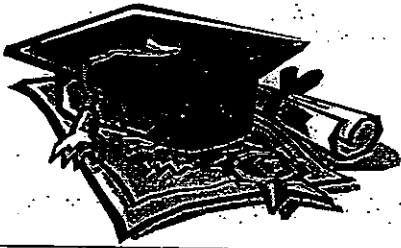

ANSWER SHEET

EXAM PAPER 2012

**SCHOOL : RAFFLES GIRLS'
SUBJECT : PRIMARY 6 SCIENCE**

TERM : SA2

Q1	Q2	Q3	Q4	Q5	Q6	Q7	Q8	Q9	Q10	Q11	Q12	Q13	Q14	Q15	Q16	Q17
1	1	3	1	2	3	1	4	4	3	1	3	3	2	4	1	2

Q18	Q19	Q20	Q21	Q22	Q23	Q24	Q25	Q26	Q27	Q28	Q29	Q30
4	3	2	1	2	1	3	4	3	2	2	2	3

31)a) 5 months.

b) D/ Jun, Jul

32)a) The seedlings watered with more water grew taller than the ones watered with lesser water until the seedlings that were watered 65ml or more's daily average increase remained at 4.0cm.

b) 9ml.

33)a) i) water and mineral salts. ii) sugar.

b) The roots anchor the plant firmly to the ground.

34) Most of the sunlight was blocked by the plants found in the upper layers. Hence, the plants growing on the forest floor lacked sufficient sunlight to make food.

35)a) 1) Pour 200ml of pond water from the container into the beaker.

2) Put 5 aquatic plant A into each beaker.

3) Using the dropper, drop a few drops of pollutant X into one of the beakers.

4) Place beakers in a sunny area for 1 week.

5) Observe the number of aquatic plant A that remained alive after one week.

35)b)The aquatic plant X will die/ while the aquatic plants without pollutant will still be alive.

36)a)i)D ii)A iii)C iv)B

b)Bird X. The nest's entrance is at the bottom so rainwater cannot get in the nest, unlike the nest of Y which is exposed to the rain.

c)Top of X is covered up but the top of nest of Y is exposed so predators can spot them all easily.

37)a)S is the best conductor of heat among all the containers.

b)The water levels in the containers will be higher. The temperature difference between the water and the surrounding air is smaller, so water in the containers evaporate slower.

38)a)i)no change. ii)increase.

b)When water vapour in the surrounding air loses heat to the cooler outer surface Y, and condenses to form water droplets on the outer surface of Y. This results in an increase in mass of Y.

39)a)

b)1)400 2)800 3)0 4)0

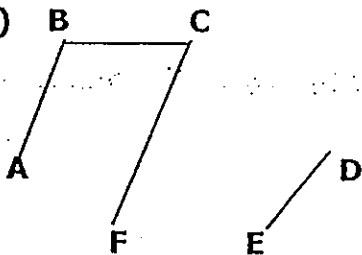

40)a)Rod S. The number of nails left in the tray was the least among all other set-up, showing that Rod S attracted the most nails.

b)The number of batteries in every set-up.

c)T is a non-magnetic material and cannot be magnetized into an electromagnet.

41)a)The force exerted by the air rushing out of the balloon was not enough to overcome the friction between the wire and the straw.

b)Blow more air into the balloon.

42)a)Chemical potential energy → heat energy → kinetic energy

b)The shorter the distance between the candle flame and the cup, the faster the spinning rate of the cup.

c)Two candles take in more oxygen and produce more carbon dioxide than one candle, resulting in more kinetic energy of the cup as the carbon dioxide will push the cup side ways due to the slits. Warm air rises and cool air sinks.

43) Y has most water which needs to gain more heat to reach the boiling point. Hence, it took the longest time to boil.

44) a) Point A. At A, the bob is at the highest point before swinging down to B. The metal bob not swing higher than its starting position at C.

b) All the gravitational potential energy is converted to kinetic energy, sound energy and heat energy.

c) There is more gravitational potential energy in the bob at point A than the bob at point D, so more gravitational potential energy was converted to more kinetic energy.

