



SERANGOON JUNIOR COLLEGE
General Certificate of Education Advanced Level
Higher 1

NAME

CG

INDEX NO.

PHYSICS

8866/01

Preliminary Examination
Paper 1 Multiple Choice

21st Sep 2017
1 hour

Additional Materials: OMS.

READ THIS INSTRUCTIONS FIRST

Write your name, civics group and index number in the spaces at the top of this page.

Write in soft pencil.

Do not use staples, paper clips, glue or correction fluid.

There are **thirty** questions in this section. Answer **all** questions. For each question there are four possible answers **A, B, C** and **D**.

Choose the **one** you consider correct and record your choice in soft pencil on the OMS.

Each correct answer will score one mark. A mark will not be deducted for a wrong answer.

Any rough working should be done in this booklet.

The use of an approved scientific calculator is expected, where appropriate.

For Examiners' Use

MCQ

/ 30

DATA AND FORMULAE

Data

| | |
|-------------------------------|---|
| speed of light in free space, | $c = 3.00 \times 10^8 \text{ m s}^{-1}$ |
| elementary charge, | $e = 1.60 \times 10^{-19} \text{ C}$ |
| the Planck constant, | $h = 6.63 \times 10^{-34} \text{ J s}$ |
| unified atomic mass constant, | $u = 1.66 \times 10^{-27} \text{ kg}$ |
| rest mass of electron, | $m_e = 9.11 \times 10^{-31} \text{ kg}$ |
| rest mass of proton, | $m_p = 1.67 \times 10^{-27} \text{ kg}$ |
| acceleration of free fall, | $g = 9.81 \text{ m s}^{-2}$ |

Formulae

| | |
|-------------------------------|-------------------------------|
| uniformly accelerated motion, | $s = ut + \frac{1}{2} at^2$ |
| | $v^2 = u^2 + 2as$ |
| work done on/by a gas, | $W = p\Delta V$ |
| hydrostatic pressure, | $p = \rho gh$ |
| resistors in series, | $R = R_1 + R_2 + \dots$ |
| resistors in parallel, | $1/R = 1/R_1 + 1/R_2 + \dots$ |

Answer all questions.

- 1 Four students conducted an experiment to determine the value of g , acceleration of free fall. The values obtained by the students are as shown in the table.

| Student | $g_1 / \text{m s}^{-2}$ | $g_2 / \text{m s}^{-2}$ | $g_3 / \text{m s}^{-2}$ | $g_4 / \text{m s}^{-2}$ |
|---------|-------------------------|-------------------------|-------------------------|-------------------------|
| P | 9.40 | 9.80 | 9.55 | 9.65 |
| Q | 9.80 | 9.60 | 9.90 | 10.06 |
| R | 10.10 | 9.90 | 10.15 | 9.85 |
| S | 9.45 | 9.48 | 9.52 | 9.55 |

If the correct value of g is 9.82 m s^{-2} , which of the students has/have the largest systematic and random errors in their experiments?

| | Largest systematic error | Largest random error |
|----------|--------------------------|----------------------|
| A | Q | S |
| B | S | Q |
| C | Q | P |
| D | P | Q |

- 2 A changing magnetic flux Φ can induce an e.m.f. E in a coil given by $E = - \frac{d\Phi}{dt}$. What are the base units of magnetic flux ?

A $\text{m s}^{-2} \text{ A}^{-1}$ **B** $\text{m s}^{-1} \text{ A}$ **C** $\text{kg m s}^{-2} \text{ A}^{-1}$ **D** $\text{kg m}^2 \text{ s}^{-2} \text{ A}^{-1}$

- 3 Lorry P and Lorry Q are initially at a distance x metres apart and are travelling in the opposite directions as shown below.

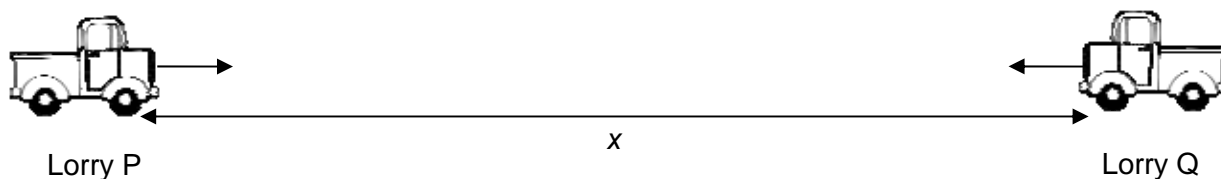

The graph shows the variation with time t of the speeds v of Lorry P and Lorry Q respectively.

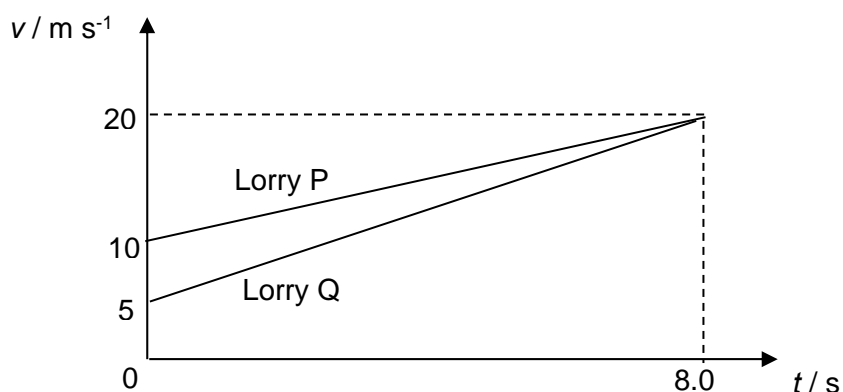

At $t = 8.0$ s, the two lorries are 40 m apart. What is x ?

- A 60 m B 120 m C 220 m D 260 m
- 4 To determine the acceleration of free fall, a steel ball is dropped above two light gates as shown.

The ball passes light gates 1 and 2 at times t_1 and t_2 respectively after release.

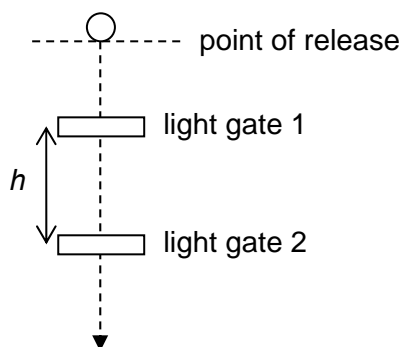

What is the acceleration of free fall?

- A $\frac{2h}{(t_2 - t_1)}$ B $\frac{2h}{(t_2^2 - t_1^2)}$ C $\frac{2h}{(t_2 - t_1)^2}$ D $\frac{2h}{\left(\frac{t_2 + t_1}{2}\right)^2}$

- 5 The graph shows how the speed v of an object varies with time t .

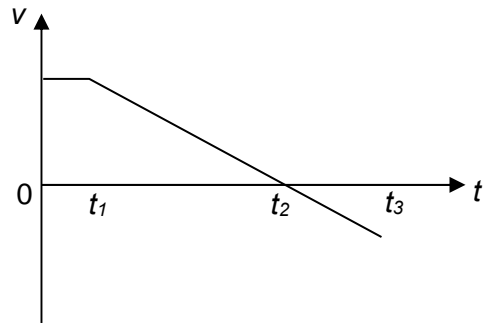

Which graph represents the variation the displacement s travelled by the object with time t ?

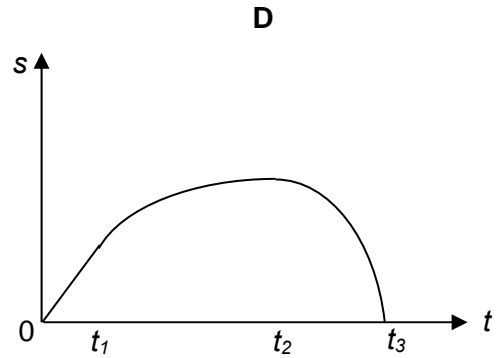
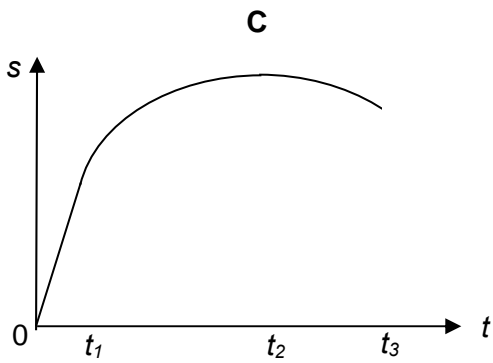
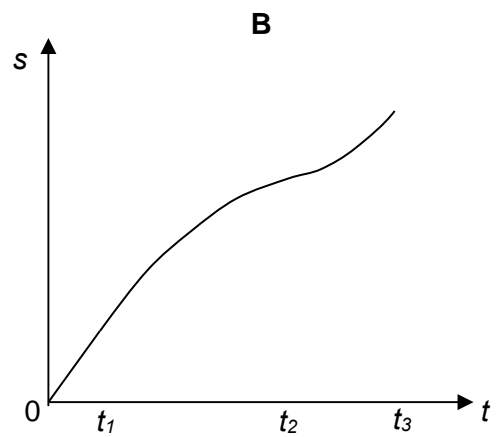
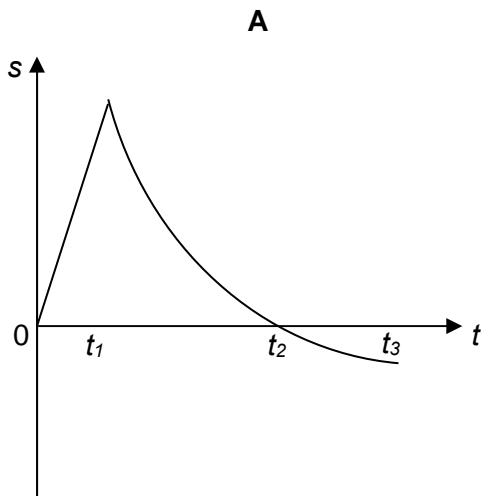

- 6 A jet of water of density 1000 kg m^{-3} leaves the nozzle of a hose of radius $2.0 \times 10^{-2} \text{ m}$. The water is directed perpendicularly to the wall at a speed of 0.50 m s^{-1} . Assume that the water does not rebound.

What is the force exerted on the wall by the water?

- A 0.314 N B 0.628 N C 1.27 N D 15.7 N
- 7 An astronaut falls vertically from a space vehicle and hops on the moon. The following statements are about the forces acting while the astronaut is in contact with the surface of the moon.

Which statement is correct?

- A The force that the astronaut exerts on the moon is always equal to the weight of the astronaut.
- B The force that the astronaut exerts on the moon is always less than the weight of the astronaut.
- C The weight of the astronaut is always equal in magnitude and opposite in direction to the force that the moon exerts on the astronaut.
- D The force that the astronaut exerts on the moon is always equal in magnitude and opposite in direction to the force the moon exerts on the astronaut.
- 8 A box of mass 8.0 kg rests on a horizontal, rough surface. A string attached to the box passes over a smooth pulley and supports a 2.0 kg mass at its other end.

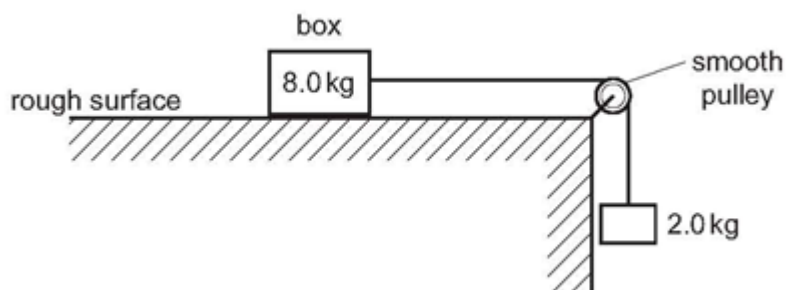

When the box is released, a friction force of 6.0 N acts on it.

What is the acceleration of the box?

- A 1.4 m s^{-2} B 1.7 m s^{-2} C 2.0 m s^{-2} D 2.5 m s^{-2}

- 9 A uniform L-shape object of dimensions in centimetres is placed on a Cartesian plane as shown.

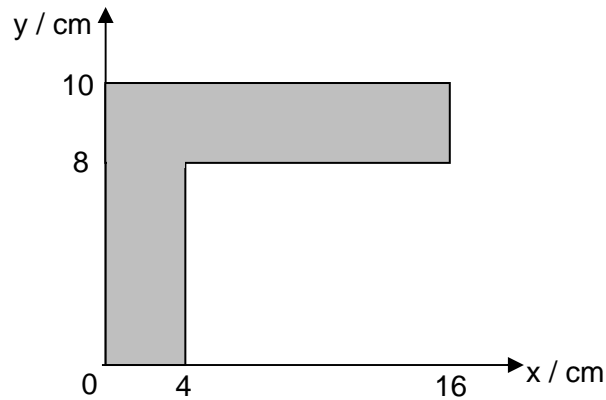

What is the location of the centre of mass of the object in the x-direction?

- A 2.0 cm B 3.5 cm C 5.0 cm D 8.0 cm
- 10 A spring of negligible mass has a spring constant of 1600 N m^{-1} . The spring is placed vertically on the floor. A 1.20 kg book is then dropped onto the spring from a height of 0.80 m above the top of the spring.

What is the maximum distance in which the spring will be compressed?

- A 0.0117 m B 0.0119 m C 0.108 m D 0.116 m
- 11 There are many forces acting on the flat object as shown. Amongst the forces, there exists a couple. What is the torque of the couple?

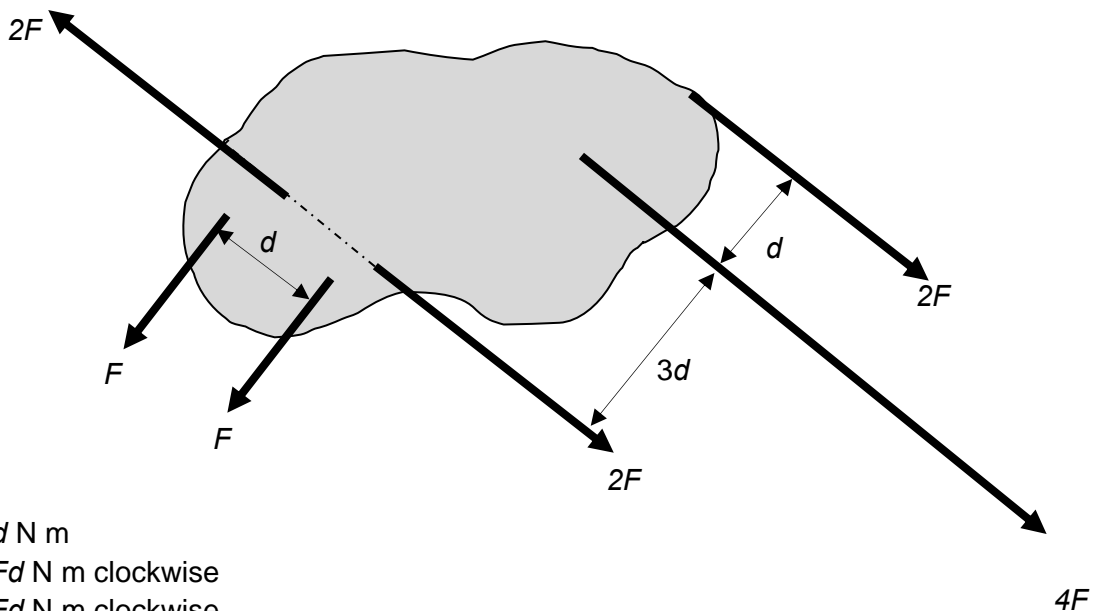

- A $Fd \text{ N m}$
 B $6Fd \text{ N m}$ clockwise
 C $8Fd \text{ N m}$ clockwise
 D $24Fd \text{ N m}$ clockwise

- 12 A student pushes a box from rest along a rough floor with constant friction of 2.0 N.

The graph shows the variation of the force exerted by the student on the box with displacement.

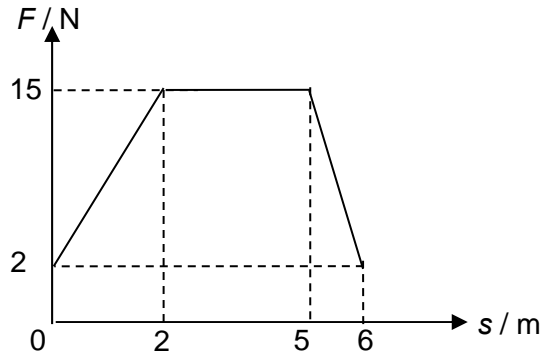

The final speed of the box after travelling 6 m is 5.0 m s^{-1} .

What is the mass of the box?

- A 4.68 kg B 5.64 kg C 23.4 kg D 28.2 kg
- 13 The graph shows how the potential energy U of an object varies with displacement x .

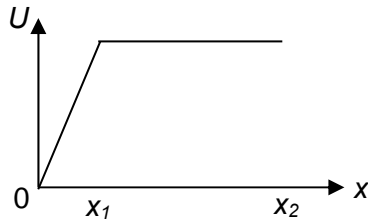

Which of the following graphs represents the variation of force acting on the object with displacement x ?

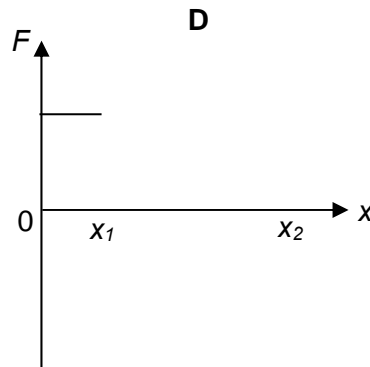
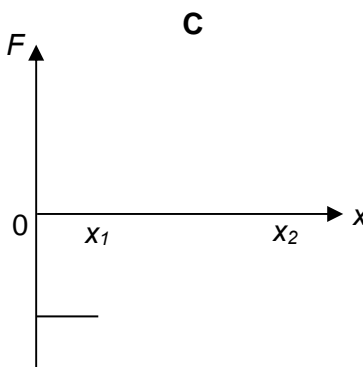
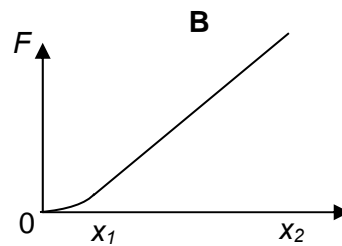
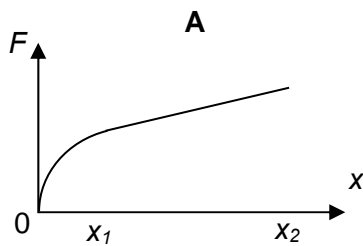

- 14 An unpolarised wave passes through polariser O such that the emerging wave is plane-polarized with an intensity of 2.0 W m^{-2} . A second polariser P is placed further such that the plane-polarised wave is incident normally on it. Polariser P is rotated clockwise by an angle of 60° .

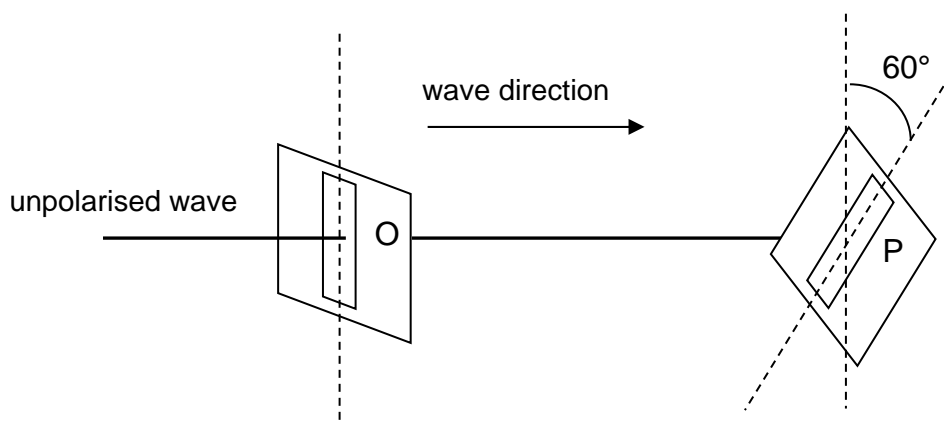

What is the intensity of the wave after passing through polariser P ?

- A 0.25 W m^{-2} B 0.5 W m^{-2} C 1.0 W m^{-2} D 2.0 W m^{-2}
- 15 The figure shows a loudspeaker which emits a sound of constant frequency. The graph shows the displacements of the air particles from their undisturbed positions at one instant in time along x . Direction to the right is taken as positive.

At which of the four points A, B, C, D is the instantaneous pressure at its minimum value?

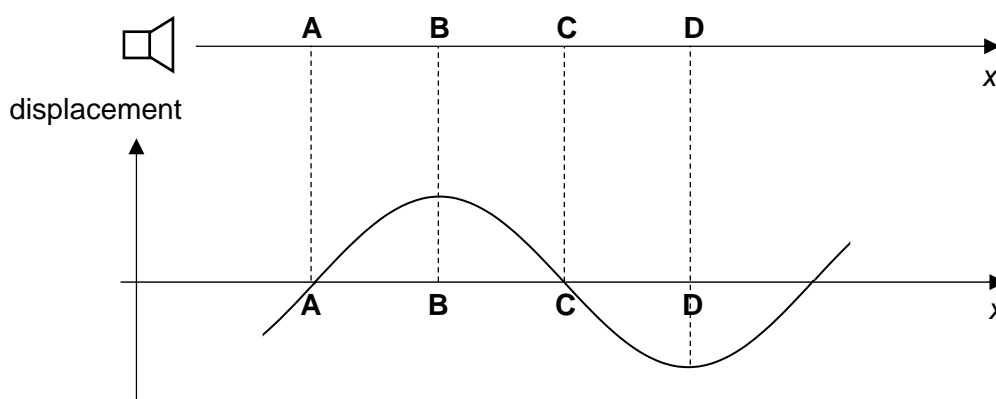

- 16 The arrows on the diagrams represent the movement of the air molecules in a pipe, opened at both ends, in which a stationary longitudinal wave has been set up. The length of each arrow represents the amplitude of the motion. Which diagram shows a possible stationary wave in which there are two displacement nodes and three displacement antinodes?

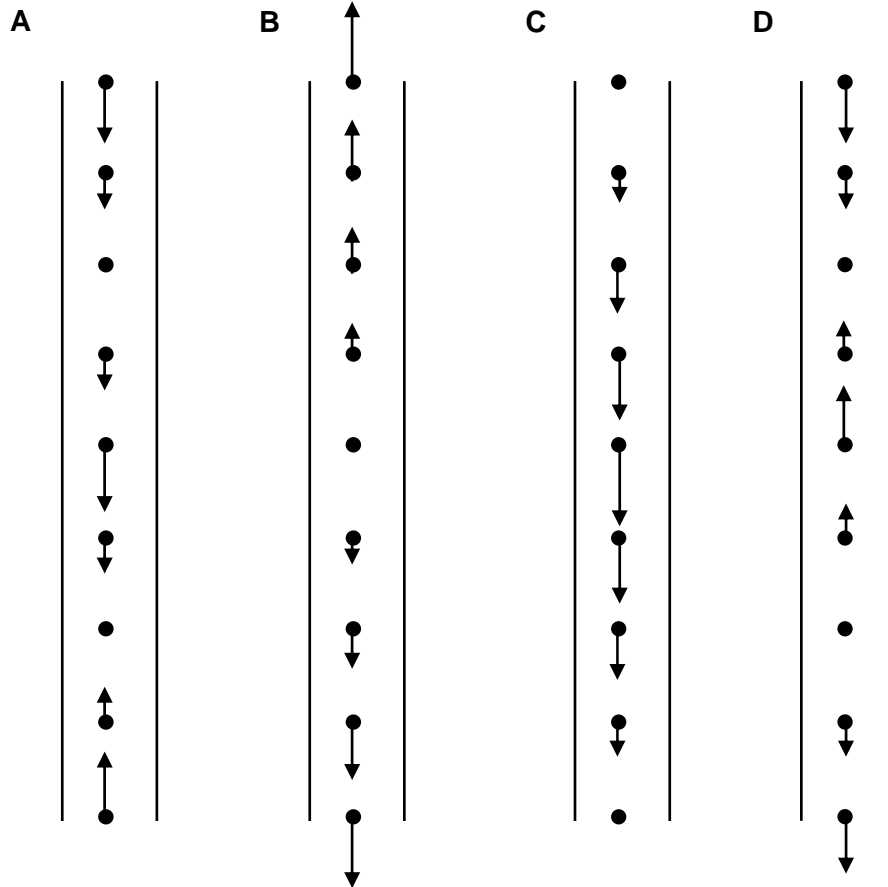

- 17 Water waves of wavelength 2.0 m are produced by two generators X and Y, placed 5.0 m apart and operating in phase. A point P is 12 m from X as shown below.

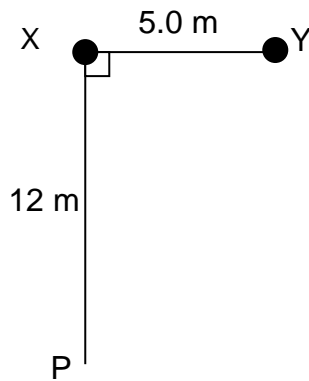

With generator X switched off, the intensity at P due to Y alone is I_0 . With generator Y switched off, the intensity at P due to X alone is $4I_0$. When both generators are switched on, what is the intensity at P?

- A** I_0 **B** $3I_0$ **C** $5I_0$ **D** $9I_0$

- 18 Which two phenomena show appropriate experimental evidence for the wave nature and the particulate nature of electromagnetic radiation?

| | wave nature | particulate nature |
|----------|----------------------|----------------------|
| A | photoelectric effect | diffraction |
| B | interference | photoelectric effect |
| C | interference | diffraction |
| D | diffraction | interference |

- 19 A generator, with output power P and output voltage V , is connected to a factory by cables of total resistance R .

What is the power input to the factory?

- A** P
- B** $P - \left(\frac{P}{V}\right)^2 R$
- C** $P - \left(\frac{P}{V}\right)^2 \frac{R}{2}$
- D** $\left(\frac{P}{V}\right)^2 R$

- 20 A d.c. supply of constant e.m.f. and internal resistance is connected to a variable resistor of resistance R .

Which of the following graphs best shows how the total power P delivered by the supply varies with R ?

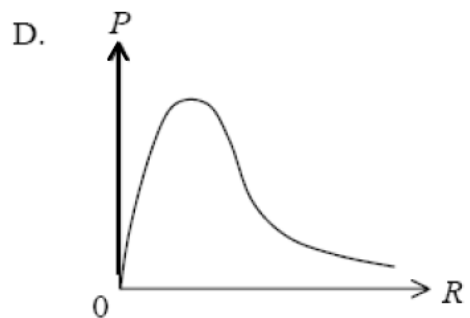
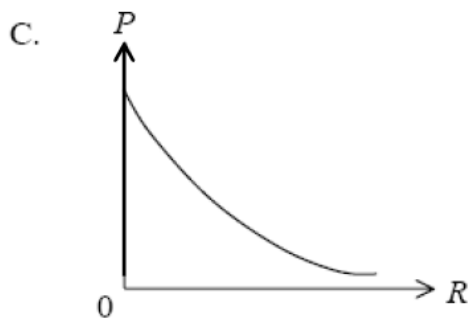
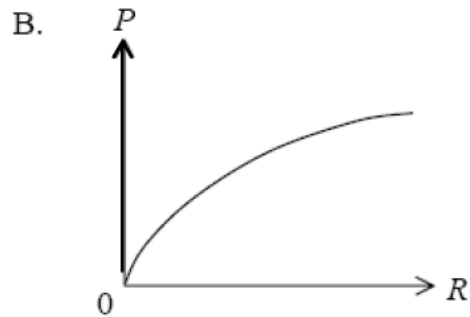
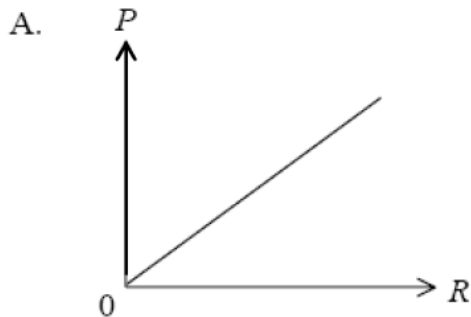

- 21 The I - V characteristics of two electrical components P and Q are shown below.

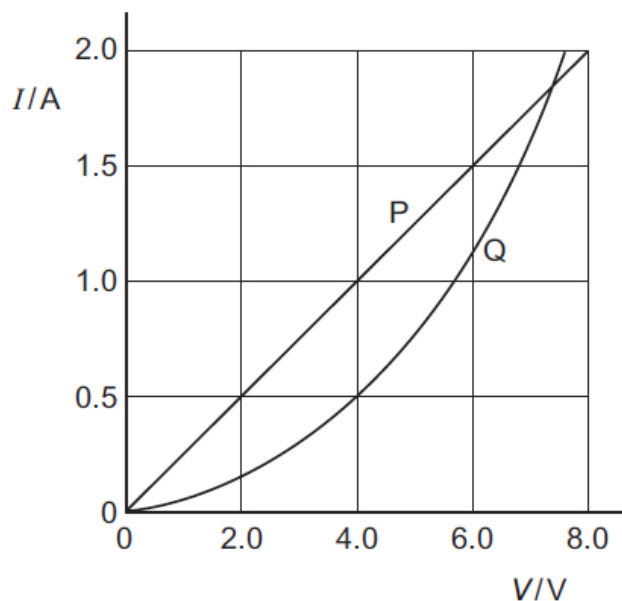

Which statement is correct?

- A At 0.5 A the power dissipated in Q is double that in P.
- B At 1.9 A the resistance of Q is approximately half that of P.
- C The resistance of Q increases as the current in it increases.
- D P is a resistor and Q is a filament lamp.

- 22 An ideal cell and four identical bulbs are connected as shown.

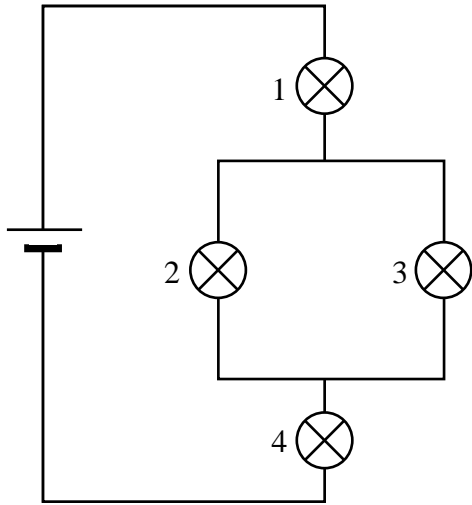

Bulb 3 is removed.

Which of the following describes the changes in the brightness of bulbs 1, 2 and 4?

| | Bulb 1 | Bulb 2 | Bulb 4 |
|---|----------|----------|----------|
| A | dimmer | brighter | brighter |
| B | dimmer | brighter | dimmer |
| C | brighter | dimmer | brighter |
| D | dimmer | dimmer | dimmer |

- 23 A light-dependent resistor (LDR) is connected in series with a fixed resistor of resistance R and a cell of e.m.f 10 V , as shown in the diagram below.

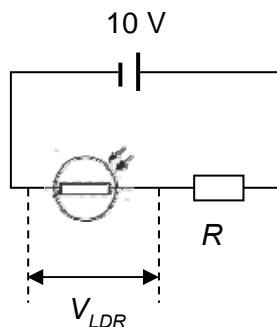

At a particular light intensity, resistance of the LDR is $5.3\ \Omega$ and the potential difference V_{LDR} across it is 4.5 V .

What is the value of V_{LDR} if the light intensity is increased and the resistance of the LDR drops to $3.1\ \Omega$?

- A 1.5 V B 2.6 V C 3.2 V D 3.5 V

- 24 A mains circuit contains six similar bulbs connected in series. One of the bulbs has a broken filament. Voltmeters X and Y of infinite resistance are placed in the circuit shown below. Which of the following voltmeter readings is correct?

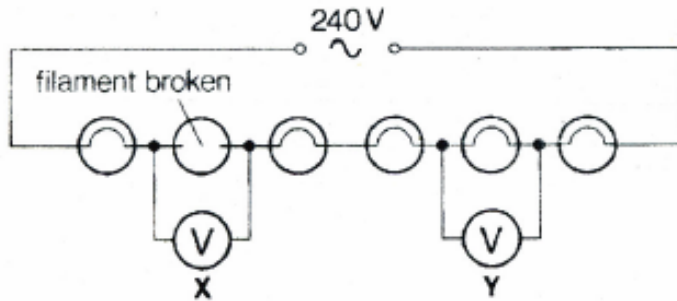

- | | Voltmeter X | Voltmeter Y |
|---|-------------|-------------|
| A | 0 V | 0 V |
| B | 0 V | 240 V |
| C | 240 V | 240 V |
| D | 240 V | 0 V |
- 25 A long solenoid of length l is connected to a cell with e.m.f. E and negligible internal resistance. The magnetic flux density at the centre of the solenoid is B_s .

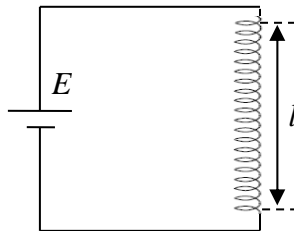

The solenoid is subsequently cut to a length of $\frac{l}{3}$ and is reconnected to the same cell as shown below.

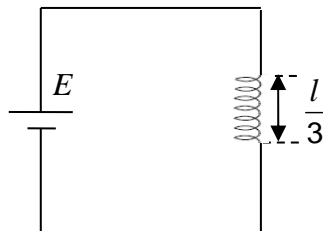

The magnetic flux density at the centre of a solenoid is equal to $\mu_0 nI$, where n is the number of turns per unit length and I is the current through the coil.

What is the magnetic flux density at the centre of the shortened solenoid?

- A $\frac{B_s}{3}$
- B B_s
- C $3B_s$
- D $6B_s$

- 26 Three particles travel through a region of space where the magnetic field is out of the page, as shown in the figure below.

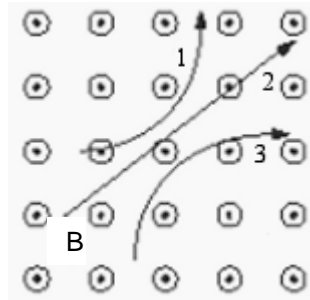

Which statement below about their charges is correct?

- A 1 is negative, 2 is neutral, and 3 is positive.
 B 1 is neutral, 2 is negative, and 3 is positive.
 C 1 is positive, 2 is negative, and 3 is neutral.
 D 1 is positive, 2 is neutral, and 3 is negative.
- 27 A bent wire PQRST carrying a current I is placed in a magnetic field of flux density B as shown. QR is the shortest and ST is the longest. PQ and RS are equal in length and both are longer than QR.

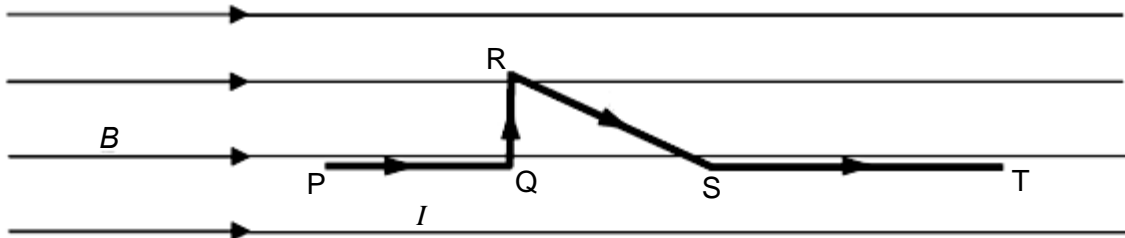

The forces acting on PQ, QR, RS and ST are given by F_{PQ} , F_{QR} , F_{RS} and F_{ST} respectively.

Which of the following is true?

- A $F_{QR} \neq F_{RS}$ and $F_{PQ} < F_{ST}$
 B $F_{QR} = F_{RS}$ and $F_{PQ} = F_{ST}$
 C $F_{QR} > F_{RS}$ and $F_{PQ} < F_{ST}$
 D $F_{QR} < F_{RS}$ and $F_{PQ} = F_{ST}$

- 28 Some of the energy levels of the hydrogen atom are represented in simplified form by the given diagram which has a linear scale. The emission of blue light is associated with the transition of an electron from E_4 to E_2 . Which of the following transitions could be associated with the absorption of the red light?

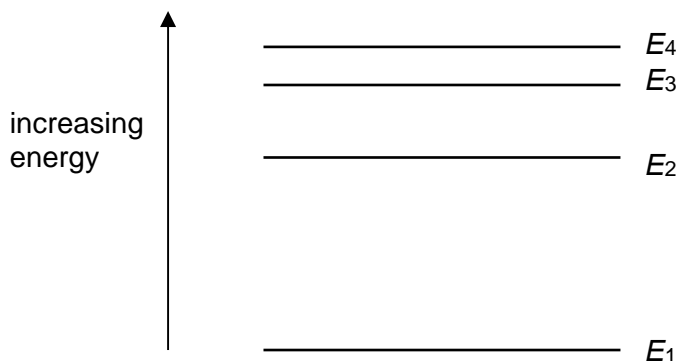

- A E_4 to E_1
 B E_3 to E_2
 C E_2 to E_3
 D E_1 to E_4
- 29 A particle of mass m has kinetic energy E . Which of the following gives the de Broglie wavelength of the particle?

A $h\sqrt{2mE}$ B $\frac{\sqrt{2mE}}{h}$ C $\frac{h}{\sqrt{mE}}$ D $\frac{h}{\sqrt{2mE}}$

- 30 A metal surface in an evacuated tube is illuminated with monochromatic light causing the emission of photo-electrons which are collected at an adjacent electrode. For a given intensity of light, the way in which the photocurrent I depends on the potential difference V between the electrodes is as shown in the diagram below.

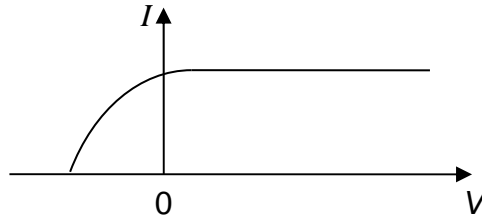

Which of the following graphs shows the result when the intensity of the light is increased? (The solid curve represents the original graph and the dotted curve represents the new graph.)

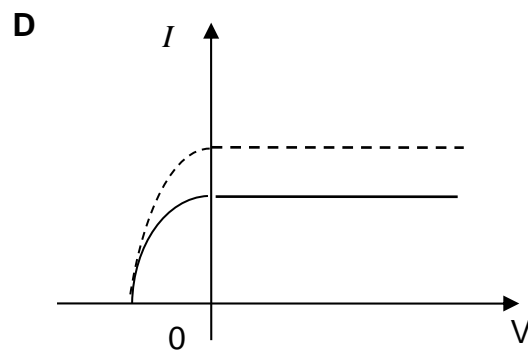
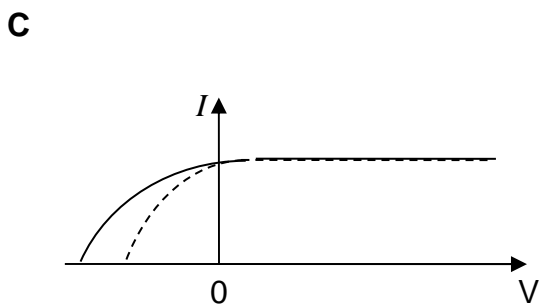
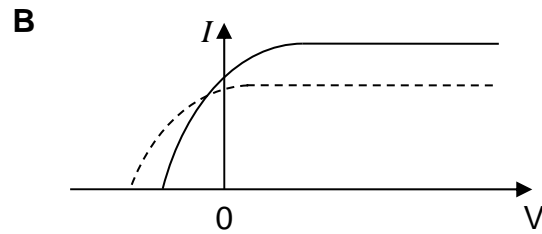
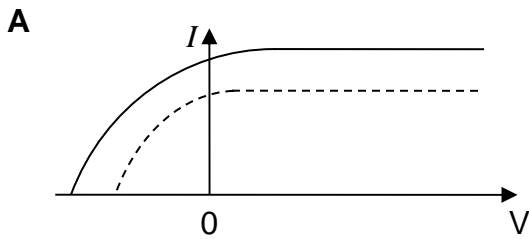

END OF PAPER



SERANGOON JUNIOR COLLEGE
General Certificate of Education Advanced Level
Higher 1

NAME

CG

INDEX NO.

PHYSICS

8866/01

Preliminary Examination
Paper 1 Multiple Choice

21st Sep 2017
1 hour

Additional Materials: OMS.

READ THIS INSTRUCTIONS FIRST

Write your name, civics group and index number in the spaces at the top of this page.

Write in soft pencil.

Do not use staples, paper clips, glue or correction fluid.

There are **thirty** questions in this section. Answer **all** questions. For each question there are four possible answers **A, B, C** and **D**.

Choose the **one** you consider correct and record your choice in soft pencil on the OMS.

Each correct answer will score one mark. A mark will not be deducted for a wrong answer.

Any rough working should be done in this booklet.

The use of an approved scientific calculator is expected, where appropriate.

| | |
|---------------------------|------|
| For Examiners' Use | |
| MCQ | / 30 |

DATA AND FORMULAE

Data

| | |
|-------------------------------|---|
| speed of light in free space, | $c = 3.00 \times 10^8 \text{ m s}^{-1}$ |
| elementary charge, | $e = 1.60 \times 10^{-19} \text{ C}$ |
| the Planck constant, | $h = 6.63 \times 10^{-34} \text{ J s}$ |
| unified atomic mass constant, | $u = 1.66 \times 10^{-27} \text{ kg}$ |
| rest mass of electron, | $m_e = 9.11 \times 10^{-31} \text{ kg}$ |
| rest mass of proton, | $m_p = 1.67 \times 10^{-27} \text{ kg}$ |
| acceleration of free fall, | $g = 9.81 \text{ m s}^{-2}$ |

Formulae

| | |
|-------------------------------|--|
| uniformly accelerated motion, | $s = ut + \frac{1}{2} at^2$ $v^2 = u^2 + 2as$ |
| work done on/by a gas, | $W = p\Delta V$ |
| hydrostatic pressure, | $p = \rho gh$ |
| resistors in series, | $R = R_1 + R_2 + \dots$ |
| resistors in parallel, | $1/R = 1/R_1 + 1/R_2 + \dots$ |

Answer all questions.

- 1 Four students conducted an experiment to determine the value of g , acceleration of free fall. The values obtained by the students are as shown in the table.

| Student | $g_1 / \text{m s}^{-2}$ | $g_2 / \text{m s}^{-2}$ | $g_3 / \text{m s}^{-2}$ | $g_4 / \text{m s}^{-2}$ |
|---------|-------------------------|-------------------------|-------------------------|-------------------------|
| P | 9.40 | 9.80 | 9.55 | 9.65 |
| Q | 9.80 | 9.60 | 9.90 | 10.06 |
| R | 10.10 | 9.90 | 10.15 | 9.85 |
| S | 9.45 | 9.48 | 9.52 | 9.55 |

If the correct value of g is 9.82 m s^{-2} , which of the students has/have the largest systematic and random errors in their experiments?

| | Largest systematic error | Largest random error |
|----------|--------------------------|----------------------|
| A | Q | S |
| B | S | Q |
| C | Q | P |
| D | P | Q |

Ans : B

| Student | Mean | Range |
|---------|--|----------------------|
| P | 9.60 | 0.4 |
| Q | 9.84 | 0.46 (biggest range) |
| R | 10.0 | 0.3 |
| S | 9.50 (biggest diff to correct value of 9.82 m s^{-2}) | 0.1 |

- 2 A changing magnetic flux Φ can induce an e.m.f. E in a coil given by $E = - \frac{d\Phi}{dt}$. What are the base units of magnetic flux ?

A $\text{m s}^{-2} \text{ A}^{-1}$ **B** $\text{m s}^{-1} \text{ A}$ **C** $\text{kg m s}^{-2} \text{ A}^{-1}$ **D** $\text{kg m}^2 \text{ s}^{-2} \text{ A}^{-1}$

Ans : D

$$\begin{aligned}
 \text{Base unit of } \Phi &= [\text{emf}][t] \\
 &= [P]/[I] \times [t] \\
 &= [\text{energy}]/([t] \times [I]) \times [t] \\
 &= \text{kg m}^2 \text{ s}^{-2} \text{ A}^{-1}
 \end{aligned}$$

- 3 Lorry P and Lorry Q are initially at a distance x metres apart and are travelling in the opposite directions as shown below.

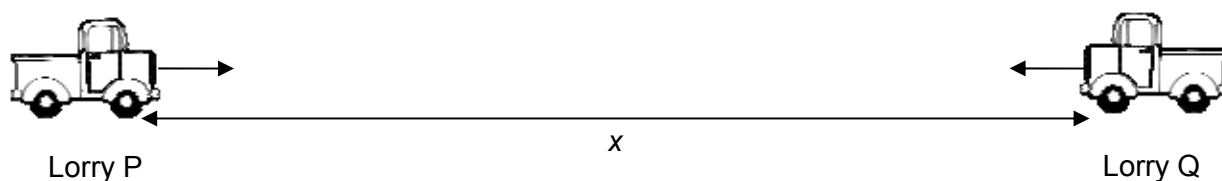

The graph shows the variation with time t of the speeds v of Lorry P and Lorry Q respectively.

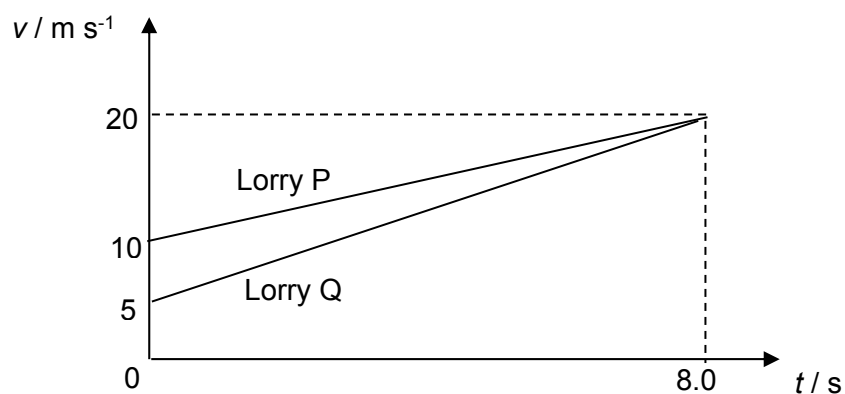

At $t = 8.0$ s, the two lorries are 40 m apart. What is x ?

- A** 60 m **B** 120 m **C** 220 m **D** 260 m

Answer: D

Distance travelled by Lorry P + Distance travelled by Lorry Q + 40 = x

$$\frac{1}{2}(10 + 20)(8.0) + \frac{1}{2}(5 + 20)(8.0) + 40 = x$$

$$x = 260 \text{ m}$$

- 4 To determine the acceleration of free fall, a steel ball is dropped above two light gates as shown.

The ball passes light gates 1 and 2 at times t_1 and t_2 respectively after release.

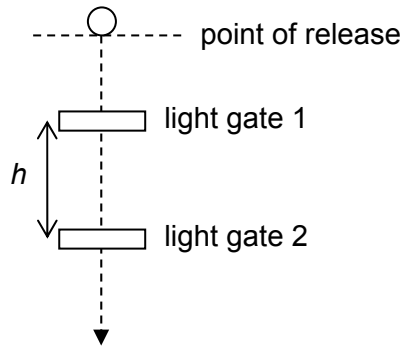

What is the acceleration of free fall?

- A $\frac{2h}{(t_2 - t_1)}$ B $\frac{2h}{(t_2^2 - t_1^2)}$ C $\frac{2h}{(t_2 - t_1)^2}$ D $\frac{2h}{\left(\frac{t_2 + t_1}{2}\right)^2}$

Answer: B

$$h = s_2 - s_1$$

$$= \frac{1}{2}gt_2^2 - \frac{1}{2}gt_1^2 \quad \text{since } u = 0$$

$$g = \frac{2h}{(t_2^2 - t_1^2)}$$

- 5 The graph shows how the speed v of an object varies with time t .

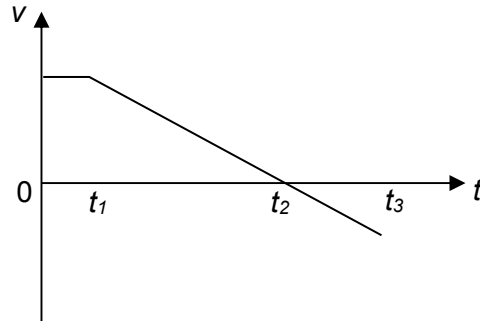

Which graph represents the variation the displacement s travelled by the object with time t ?

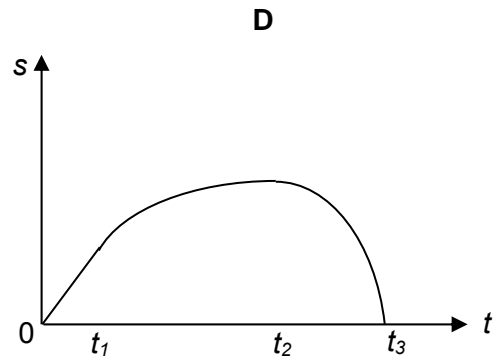
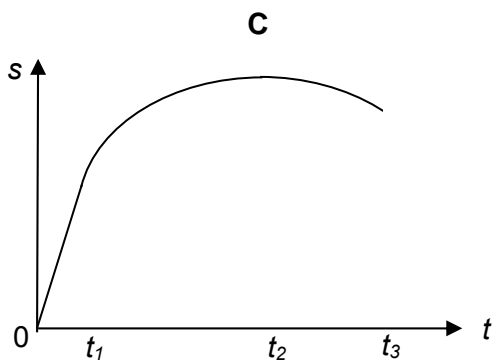
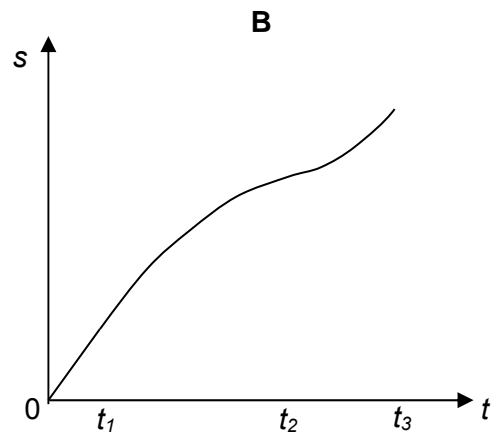
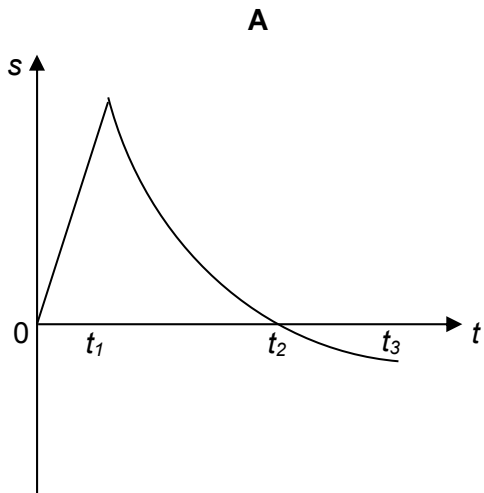

Answer: C

The area under v - t graph represents the change in displacement.

- 6 A jet of water of density 1000 kg m^{-3} leaves the nozzle of a hose of radius $2.0 \times 10^{-2} \text{ m}$. The water is directed perpendicularly to the wall at a speed of 0.50 m s^{-1} . Assume that the water does not rebound.

What is the force exerted on the wall by the water?

- A 0.314 N B 0.628 N C 1.27 N D 15.7 N

Answer: A

$$\begin{aligned}
 \text{Force by wall on water} &= \langle F_{net} \rangle = \text{mass per unit time} \times \Delta v \\
 &= \frac{m}{\Delta t} \Delta v = \frac{\rho(\text{Vol})}{\Delta t} \Delta v \quad \text{since } m = \rho(\text{Vol}) \\
 &= \frac{\rho \times \pi r^2 L}{t} \Delta v \\
 &= \rho \times \pi r^2 v \Delta v \\
 &= \rho \pi r^2 v(0 - v) \\
 &= -\rho \pi r^2 v^2 \\
 &= -1000\pi(2.0 \times 10^{-2})^2(0.50)^2 \\
 &= -0.314 \text{ N}
 \end{aligned}$$

By Newton's 3rd Law, Force by water on wall = Force by wall on water = 0.314 N

- 7 An astronaut falls vertically from a space vehicle and hops on the moon. The following statements are about the forces acting while the astronaut is in contact with the surface of the moon.

Which statement is correct?

- A The force that the astronaut exerts on the moon is always equal to the weight of the astronaut.
- B The force that the astronaut exerts on the moon is always less than the weight of the astronaut.
- C The weight of the astronaut is always equal in magnitude and opposite in direction to the force that the moon exerts on the astronaut.
- D The force that the astronaut exerts on the moon is always equal in magnitude and opposite in direction to the force the moon exerts on the astronaut.

Answer: D

Newton's third law

- 8 A box of mass 8.0 kg rests on a horizontal, rough surface. A string attached to the box passes over a smooth pulley and supports a 2.0 kg mass at its other end.

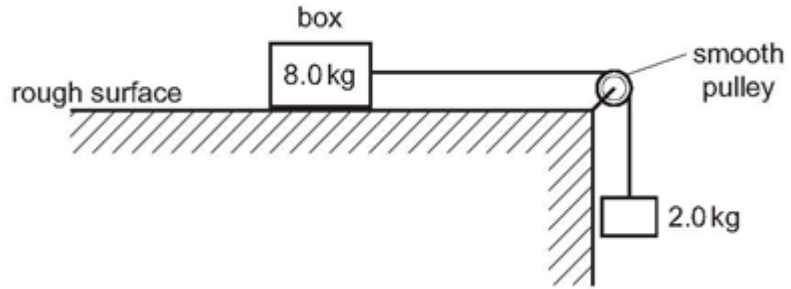

When the box is released, a friction force of 6.0 N acts on it.

What is the acceleration of the box?

- A 1.4 m s⁻² B 1.7 m s⁻² C 2.0 m s⁻² D 2.5 m s⁻²

Answer: A

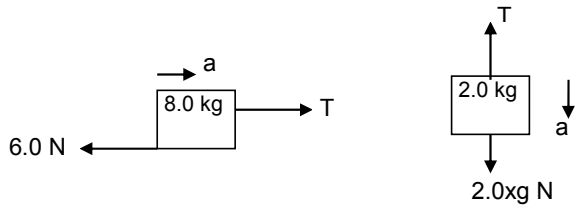

$$2.0 \times 9.81 - T = 2.0a \dots\dots (1)$$

$$T - 6.0 = 8.0a \dots\dots\dots (2)$$

From (1) & (2) $a = 1.4 \text{ m s}^{-2}$

OR

$$2.0 \times 9.81 - 6.0 = (2.0 + 8.0)a$$

$$a = 1.4 \text{ m s}^{-2}$$

- 9 A uniform L-shape object of dimensions in centimetres is placed on a Cartesian plane as shown.

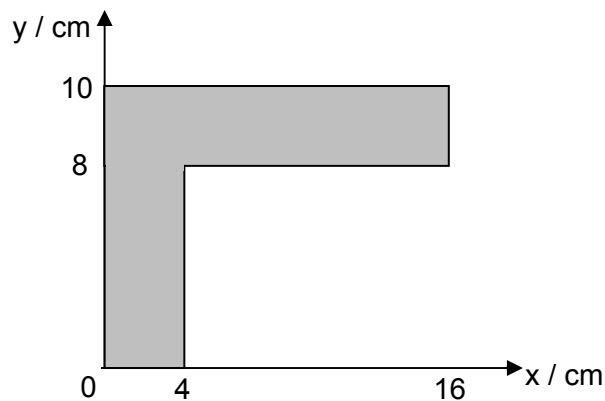

What is the location of the centre of mass of the object in the x-direction?

- A 2.0 cm B 3.5 cm C 5.0 cm D 8.0 cm

Answer: C

Consider that the block is made of two parts A and B.

Let t be the thickness of the block, ρ be the density of the object

Consider the x-direction, taking moment about the origin (0, 0)

Moment due to weight of A + Moment due to weight of B

= Moment due to the weight of the block

$$(10 \times 4)(t\rho g)(2) + (12 \times 2)(t\rho g)(10) = (10 \times 4 + 12 \times 2) t\rho g x$$

$$x = 5.0 \text{ cm}$$

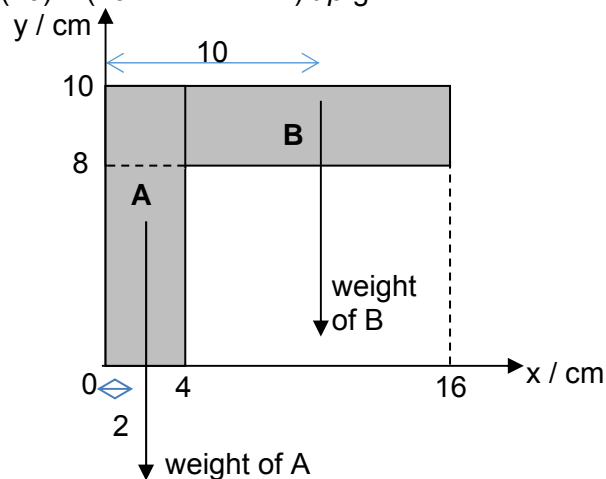

- 10 A spring of negligible mass has a spring constant of 1600 N m^{-1} . The spring is placed vertically on the floor. A 1.20 kg book is then dropped onto the spring from a height of 0.80 m above the top of the spring.

What is the maximum distance in which the spring will be compressed?

- A 0.0117 m B 0.0119 m C 0.108 m D 0.116 m

Answer: D

Loss in GPE = Gain in EPE

$$1.20 (9.81)(0.80 + x) = \frac{1}{2}(1600)x^2$$

$$x = 0.116 \text{ m}$$

- 11 There are many forces acting on the flat object as shown. Amongst the forces, there exists a couple. What is the torque of the couple?

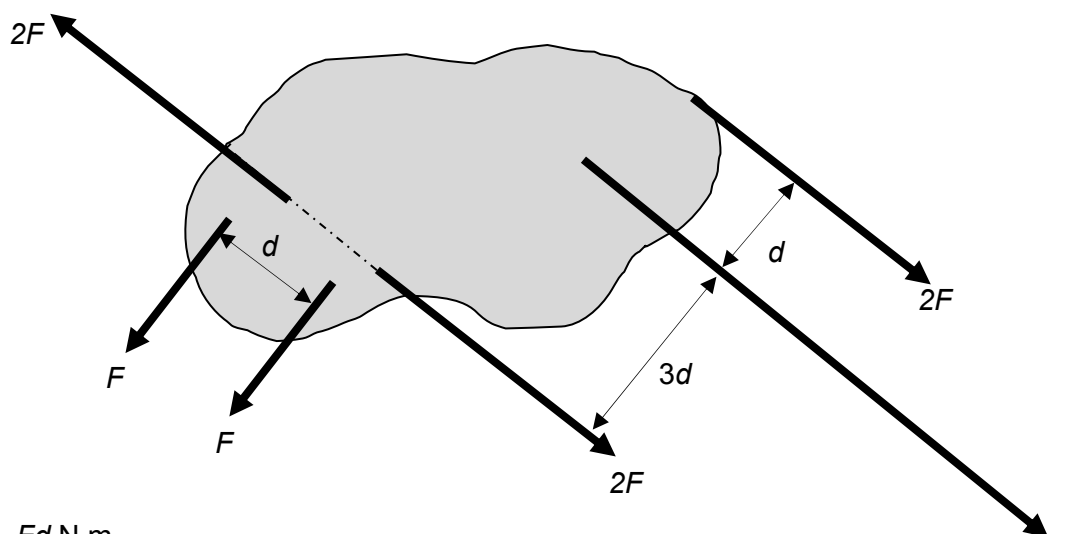

- A Fd N m
 B $6Fd$ N m clockwise
 C $8Fd$ N m clockwise
 D $24Fd$ N m clockwise

Answer: C

Torque of the couple

$$= (2F)(4d)$$

$$= 8Fd \text{ Nm clockwise}$$

- 12 A student pushes a box from rest along a rough floor with constant friction of 2.0 N.

The graph shows the variation of the force exerted by the student on the box with displacement.

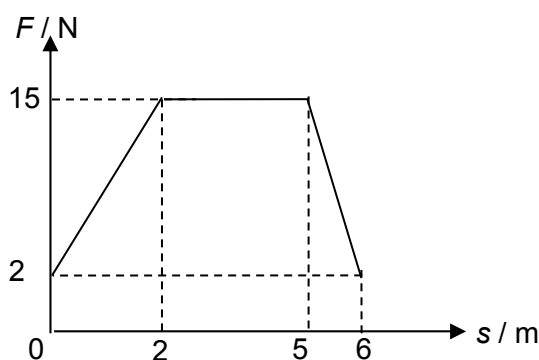

The final speed of the box after travelling 6 m is 5.0 m s^{-1} .

What is the mass of the box?

- A 4.68 kg B 5.64 kg C 23.4 kg D 28.2 kg

Answer: A

Using Work-energy theorem,

Net work done = Gain in KE

Work done by $F_{net} = KE_f - 0$

$$\frac{1}{2}(3+6)(13) - 2.0(6) = \frac{1}{2}m(5.0)^2 - 0$$

$$m = 4.68 \text{ kg}$$

- 13 The graph how the potential energy U of an object varies with displacement x .

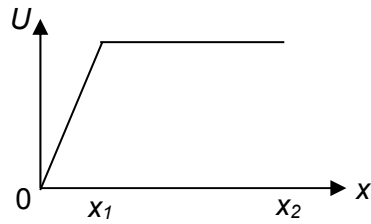

Which of the following graphs represents the variation of force acting on the object with displacement x ?

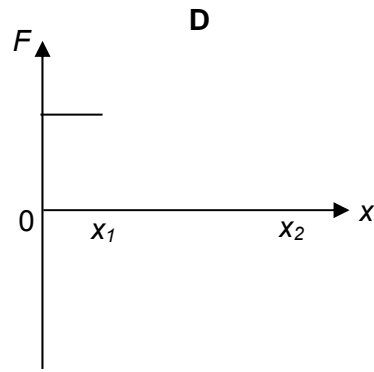
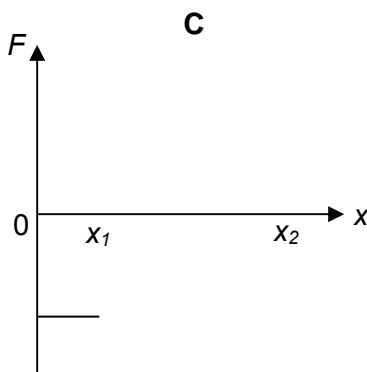
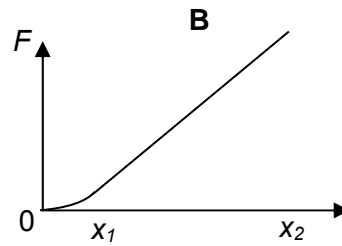
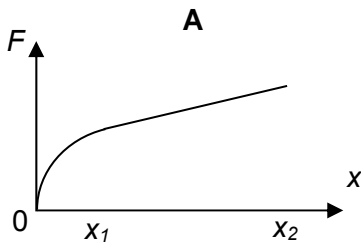

Answer: C

Using $F = -dU/dx$, the graph of $F - x$ will be the negative of potential gradient.

- 14 An unpolarised wave passes through polariser O such that the emerging wave is plane-polarized with an intensity of 2.0 W m^{-2} . A second polariser P is placed further such that the plane-polarised wave is incident normally on it. Polariser P is rotated clockwise by an angle of 60° .

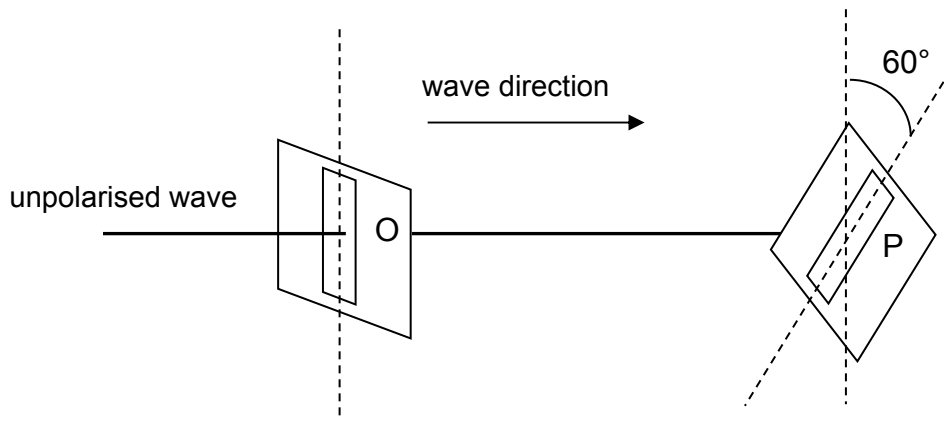

What is the intensity of the wave after passing through polariser P ?

- A 0.25 W m^{-2} B 0.5 W m^{-2} C 1.0 W m^{-2} D 2.0 W m^{-2}

Ans : B

$$\begin{aligned} \text{Using Malus' Law, } I_p &= I_o \cos^2 \theta \\ &= 2.0 (\cos^2 60^\circ) = 0.5 \text{ W m}^{-2} \end{aligned}$$

- 15 The figure shows a loudspeaker which emits a sound of constant frequency. The graph shows the displacements of the air particles from their undisturbed positions at one instant in time along x. Direction to the right is taken as positive. At which of the four points A, B, C, D is the instantaneous pressure at its minimum value?

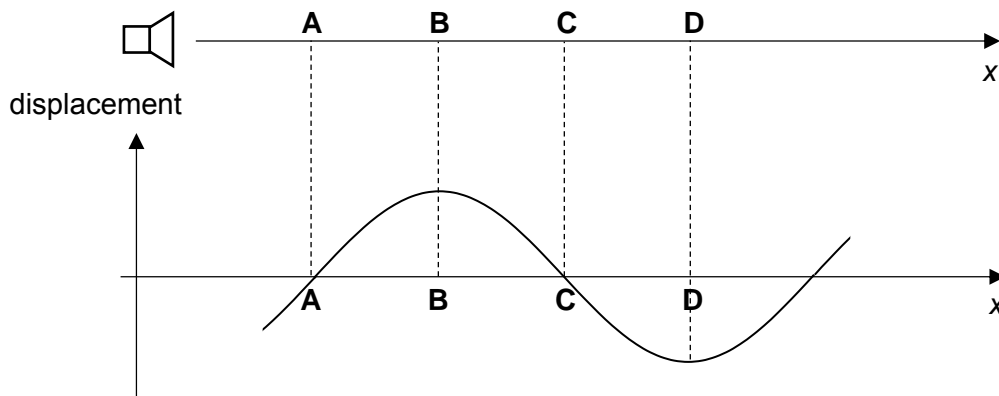

Ans : A

Particles on the left of A move to the left whereas those on the right of A move to the right, hence pressure at C is the least.

- 16 The arrows on the diagrams represent the movement of the air molecules in a pipe, opened at both ends, in which a stationary longitudinal wave has been set up. The length of each arrow represents the amplitude of the motion. Which diagram shows a possible stationary wave in which there are two displacement nodes and three displacement antinodes?

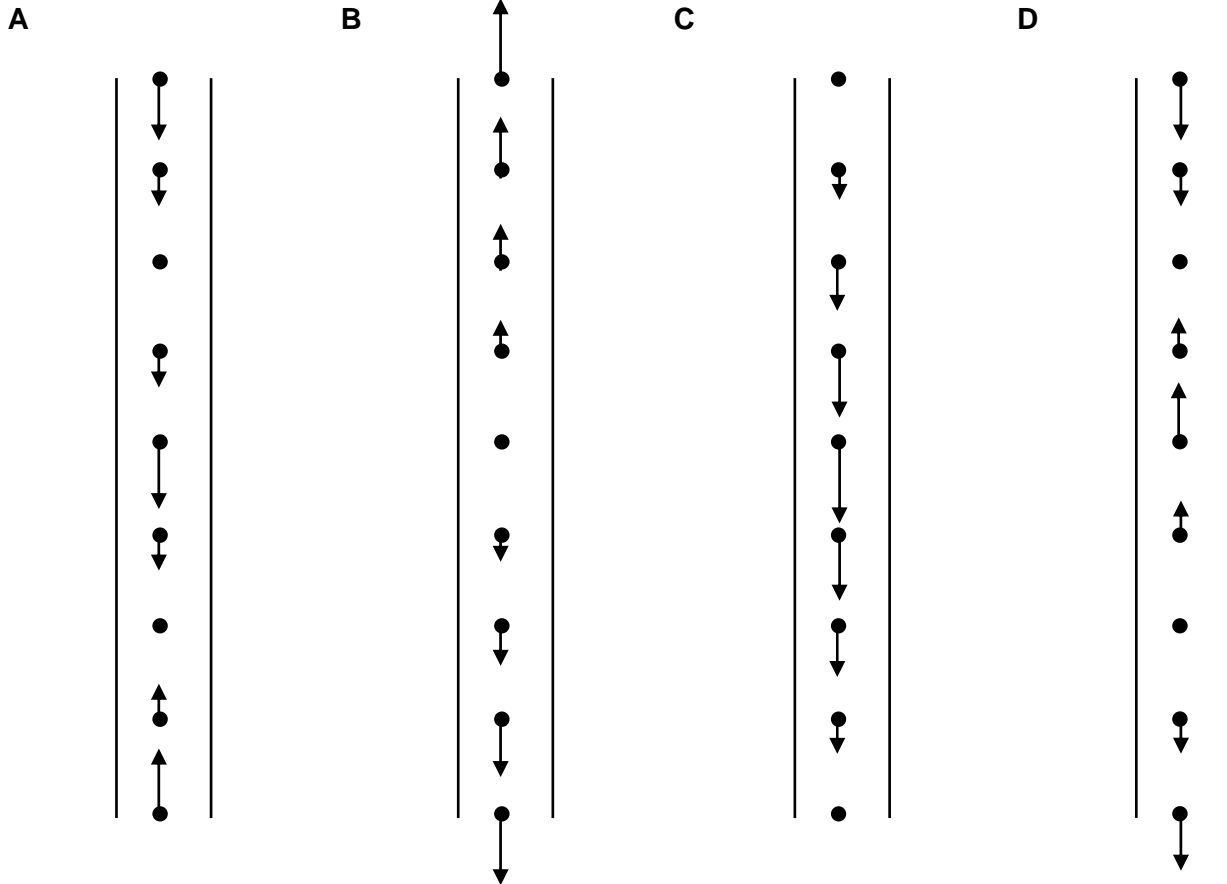

Answer: D

Option B does not show 2 displacement nodes.

Option C shows 2 displacement nodes at each of the ends of the open pipes which is not true for stationary waves in open-ended pipes.

For Option A (Top to bottom) – direction of oscillation does not change after the 1st node from the top, which is untrue.

For Option D – direction of oscillation is different on both sides of each node position, which is true.

- 17 Water waves of wavelength 2.0 m are produced by two generators X and Y, placed 5.0 m apart and operating in phase. A point P is 12 m from X as shown below.

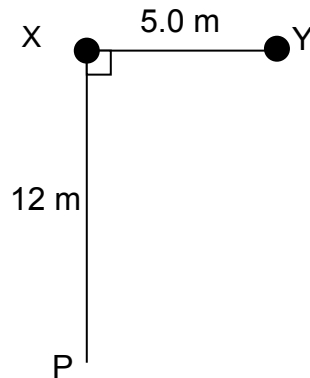

With generator X switched off, the intensity at P due to Y alone is I_0 . With generator Y switched off, the intensity at P due to X alone is $4I_0$. When both generators are switched on, what is the intensity at P?

- A I_0 B $3I_0$ C $5I_0$ D $9I_0$

Answer: A

$$I \propto A^2 \quad \text{Thus,} \quad A_Y = k\sqrt{I_0} \quad A_X = k\sqrt{4I_0} = 2k\sqrt{I_0}$$

At P, path difference = $13 - 12 = 1 \text{ m} = \frac{1}{2}\lambda$, so destructive interference takes place.

$$\text{Resultant amplitude at P,} \quad A_{\text{total}} = A_X - A_Y = k\sqrt{I_0}$$

$$\text{so } I_{\text{total}} \propto A_{\text{total}}^2 = I_0$$

- 18 Which two phenomena show appropriate experimental evidence for the wave nature and the particulate nature of electromagnetic radiation?

| | wave nature | particulate nature |
|---|----------------------|----------------------|
| A | photoelectric effect | diffraction |
| B | interference | photoelectric effect |
| C | interference | diffraction |
| D | diffraction | interference |

Answer: B

Interference and diffraction show evidence for wave nature, while photoelectric effect shows evidence for particulate nature of electromagnetic radiation.

- 19 A generator, with output power P and output voltage V , is connected to a factory by cables of total resistance R .

What is the power input to the factory?

- A P
 B $P - \left(\frac{P}{V}\right)^2 R$
 C $P - \left(\frac{P}{V}\right)^2 \frac{R}{2}$
 D $\left(\frac{P}{V}\right)^2 R$

Ans: B

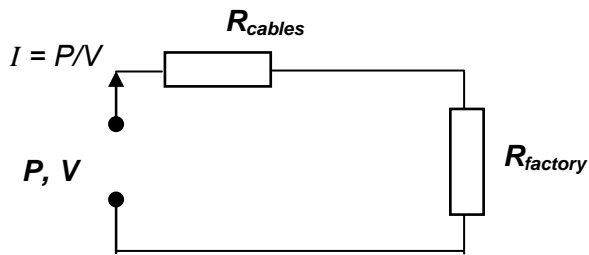

$$\begin{aligned} \text{Power input to factory} &= P - \text{power loss in cables} \\ &= P - I^2 R_{\text{cables}} \\ &= P - \left(\frac{P}{V}\right)^2 R \end{aligned}$$

- 20 A d.c. supply of constant e.m.f. and internal resistance is connected to a variable resistor of resistance R . Which of the following graphs best shows how the total power P **delivered** by the supply varies with R ?

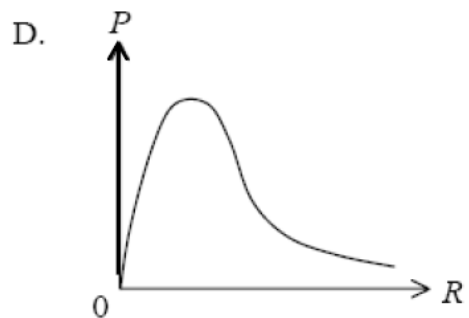
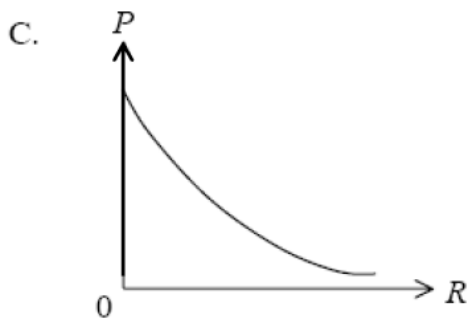
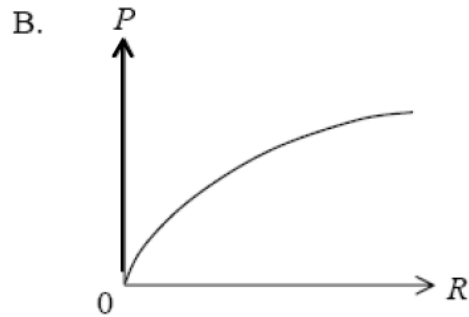
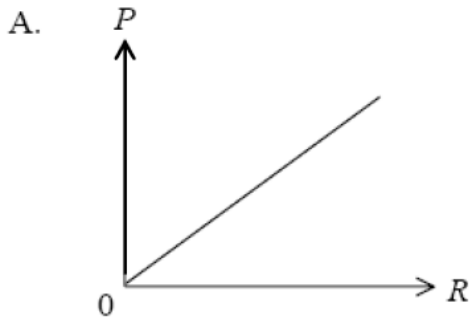

Ans: C

Power delivered by supply = $E^2 / (R + r)$; with E and r as constants.
 (so, when R increases, power decreases).

- 21 The I - V characteristics of two electrical components P and Q are shown below.

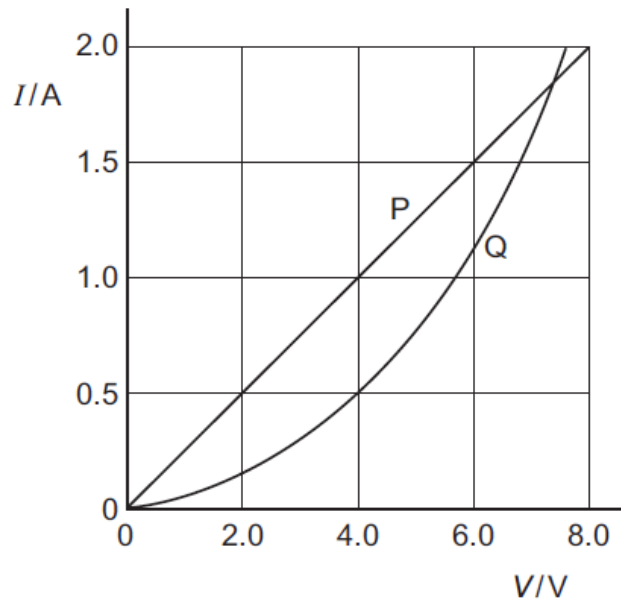

Which statement is correct?

- A At 0.5 A the power dissipated in Q is double that in P.
- B At 1.9 A the resistance of Q is approximately half that of P.
- C The resistance of Q increases as the current in it increases.
- D P is a resistor and Q is a filament lamp.

Ans: A

Ans: A

- A. $P = IV$. When the current is constant 0.5 A, the potential difference at Q is double that at P.
- B. At 1.9 A, the resistance ($R = V/I$ ratio) is approximately the same.
- C. Resistance of Q decreases as current in it decreases.
- D. Q is a thermistor.

- 22 An ideal cell and four identical bulbs are connected as shown.

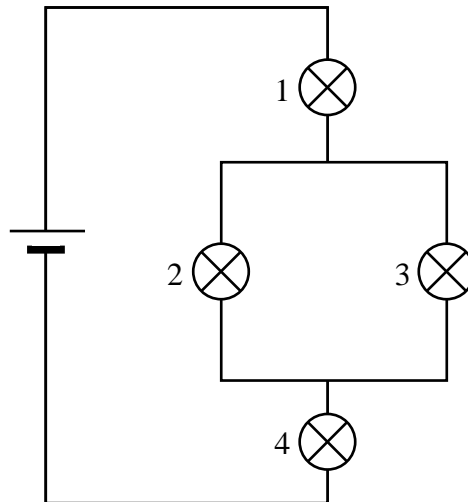

Bulb 3 is removed. Which of the following describes the changes in the brightness of bulbs 1, 2 and 4?

| | Bulb 1 | Bulb 2 | Bulb 4 |
|----------|----------|----------|----------|
| A | dimmer | brighter | brighter |
| B | dimmer | brighter | dimmer |
| C | brighter | dimmer | brighter |
| D | dimmer | dimmer | dimmer |

Ans: B

With bulb 3 in parallel to bulb 2, the potential difference across bulb 2 is a smaller fraction of the cell's e.m.f as compared to that of bulbs 1 and 4.

With bulb 3 removed, the potential difference across bulb 2 increases while those of bulb 1 and bulb 4 decrease correspondingly. With fixed resistance, power dissipated increases as potential increases, hence bulbs 1 and 4 became dimmer and bulb 2 became brighter.

Alternatively,

Before bulb 3 was removed,

$$R_{total} = R + \left(\frac{1}{R} + \frac{1}{R} \right) + R = 2.5R$$

$$I_{total} = \frac{V}{2.5R} = 0.4 \frac{V}{R} = I_{bulb1} = I_{bulb4}$$

$$I_{bulb2} = I_{bulb3} = 0.2 \frac{V}{R}$$

After bulb 3 was removed,

$$R_{total} = R + R + R = 3R$$

$$I_{total} = \frac{V}{3R} = 0.33 \frac{V}{R} = I_{bulb1} = I_{bulb2} = I_{bulb4}$$

$\therefore I_{bulb1}$ and I_{bulb4} decreased, I_{bulb2} increased

since brightness \propto power dissipated $= I^2 R$

bulbs 1 and 4 became dimmer, bulb 2 became brighter

- 23 A light-dependent resistor (LDR) is connected in series with a fixed resistor of resistance R and a cell of e.m.f 10 V, as shown in the diagram below.

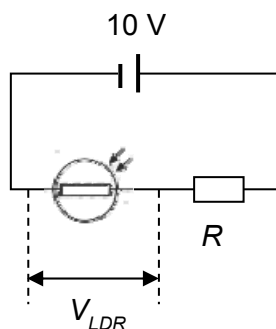

At a particular light intensity, resistance of the LDR is 5.3Ω and the potential difference V_{LDR} across it is 4.5 V.

What is the value of V_{LDR} if the light intensity is increased and the resistance of the LDR drops to 3.1Ω ?

- A** 1.5 V **B** 2.6 V **C** 3.2 V **D** 3.5 V

Ans: C

$$\text{When resistance of LDR is } 5.3 \Omega, V_{LDR} = \frac{5.3}{5.3 + R} \times 10 = 4.5$$

By PDP, $\Rightarrow R = 6.478 \Omega$

$$\text{When resistance of LDR is } 3.1 \Omega, V_{LDR} = \frac{3.1}{6.478 + 3.1} \times 10 = 3.2 \text{ V}$$

- 24 A mains circuit contains six similar bulbs connected in series. One of the bulbs has a broken filament. Voltmeters X and Y of infinite resistance are placed in the circuit shown below. Which of the following voltmeter readings is correct?

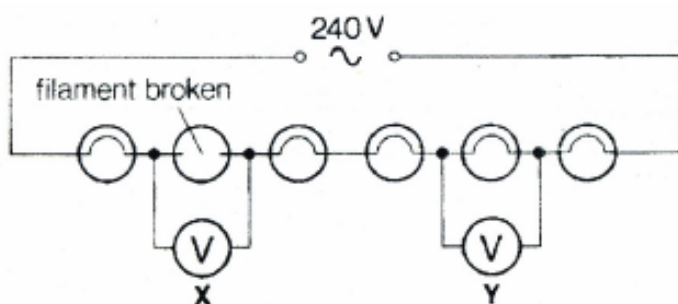

- | | Voltmeter X | Voltmeter Y |
|----------|--------------------|--------------------|
| A | 0 V | 0 V |
| B | 0 V | 240 V |
| C | 240 V | 240 V |
| D | 240 V | 0 V |

Ans: D

Due to broken bulb, current in circuit is zero. So, the potential difference across ALL bulbs $V = IR$ is zero, EXCEPT the broken bulb (which has p.d. of 240 V).

- 25 A long solenoid of length l is connected to a cell with e.m.f. E and negligible internal resistance. The magnetic flux density at the centre of the solenoid is B_s .

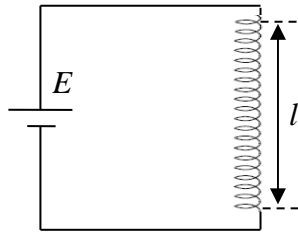

The solenoid is subsequently cut to a length of $\frac{l}{3}$ and is reconnected to the same cell as shown below.

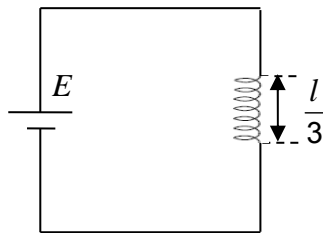

The magnetic flux density at the centre of a solenoid is equal to $\mu_0 nI$, where n is the number of turns per unit length and I is the current through the coil.

What is the magnetic flux density at the centre of the shortened solenoid?

- A $\frac{B_s}{3}$
 B B_s
 C $3B_s$
 D $6B_s$

Answer: C

Magnetic flux density $\propto I$ (since μ_0 and n are constant).

Reducing the solenoid length to one-third its original length will cause its resistance to correspondingly decrease to one-third its original value. Since the same battery is used, current I through the solenoid will triple.

- 26 Three particles travel through a region of space where the magnetic field is out of the page, as shown in the figure below.

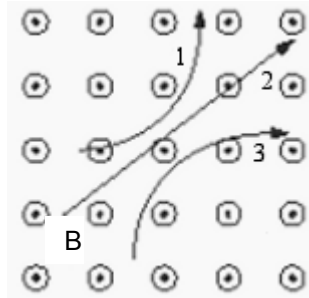

Which statement below about their charges is correct?

- A 1 is negative, 2 is neutral, and 3 is positive.
- B 1 is neutral, 2 is negative, and 3 is positive.
- C 1 is positive, 2 is negative, and 3 is neutral.
- D 1 is positive, 2 is neutral, and 3 is negative.

Answer: A

Particle 2 is neutral since its path is straight and not affected by the magnetic field. Using Fleming's Left Hand Rule, the curved paths of the particles 1 and 3 indicates that particle 1 is negatively charged whereas particle 3 is positively charged.

- 27 A bent wire PQRST carrying a current I is placed in a magnetic field of flux density B as shown. QR is the shortest and ST is the longest. PQ and RS are equal in length and both are longer than QR.

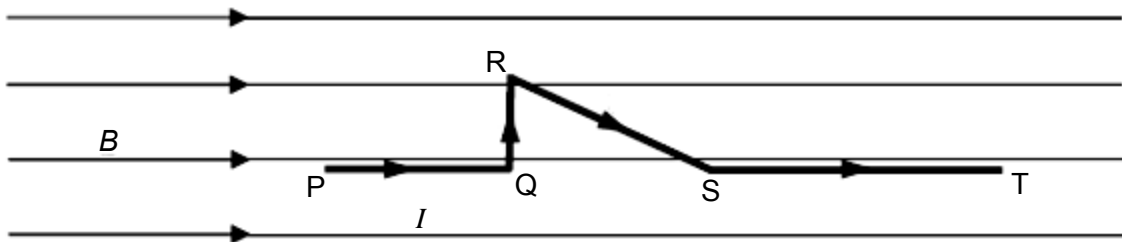

The forces acting on PQ, QR, RS and ST are given by F_{PQ} , F_{QR} , F_{RS} and F_{ST} respectively.

Which of the following is true?

- A $F_{QR} \neq F_{RS}$ and $F_{PQ} < F_{ST}$
- B $F_{QR} = F_{RS}$ and $F_{PQ} = F_{ST}$
- C $F_{QR} > F_{RS}$ and $F_{PQ} < F_{ST}$
- D $F_{QR} < F_{RS}$ and $F_{PQ} = F_{ST}$

Answer: B

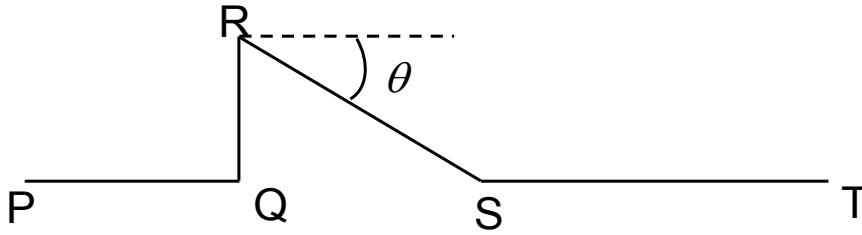

$$L_{RS} \sin\theta = L_{QR}$$

$$F_{QR} = BI(L_{QR}) = BI(L_{RS} \sin\theta) = F_{RS}$$

L_{PQ} and L_{ST} are parallel to B-field

$$F_{PQ} = F_{ST} = 0$$

- 28 Some of the energy levels of the hydrogen atom are represented in simplified form by the given diagram which has a linear scale. The emission of blue light is associated with the transition of an electron from E_4 to E_2 . Which of the following transitions could be associated with the absorption of the red light ?

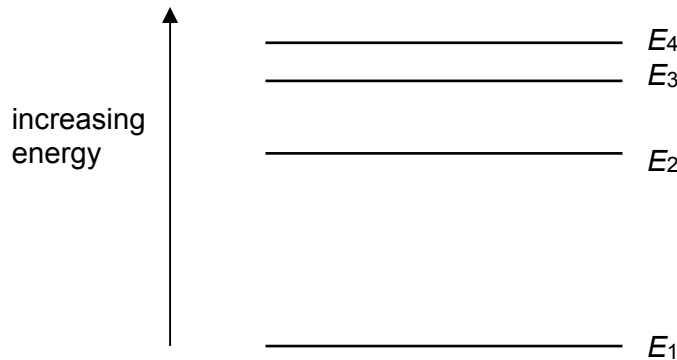

- A E_4 to E_1
 B E_3 to E_2
 C E_2 to E_3
 D E_1 to E_4

Ans : C

Absorption transition is in the direction of increasing energy.

$$\Delta E = hf$$

Since $f_{\text{red}} < f_{\text{blue}}$, therefore $\Delta E_{\text{red}} < \Delta E_{\text{blue}}$

- 29 A particle of mass m has kinetic energy E . Which of the following gives the de Broglie wavelength of the particle?

- A $h\sqrt{2mE}$ B $\frac{\sqrt{2mE}}{h}$ C $\frac{h}{\sqrt{mE}}$ D $\frac{h}{\sqrt{2mE}}$

Ans: D

$$E = \frac{1}{2} mv^2 = \frac{p^2}{2m}$$

$$\text{Therefore, } p = \sqrt{2mE}$$

$$\lambda = h/p = h/\sqrt{2mE}$$

- 30 A metal surface in an evacuated tube is illuminated with monochromatic light causing the emission of photo-electrons which are collected at an adjacent electrode. For a given intensity of light, the way in which the photocurrent I depends on the potential difference V between the electrodes is as shown in the diagram below.

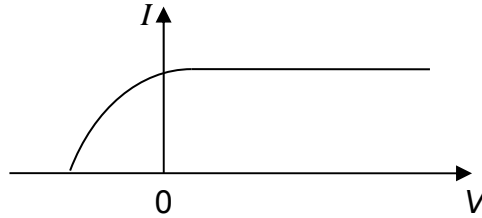

Which of the following graphs shows the result when the intensity of the light is increased? (The solid curve represents the original graph and the dotted curve represent the new graph.)

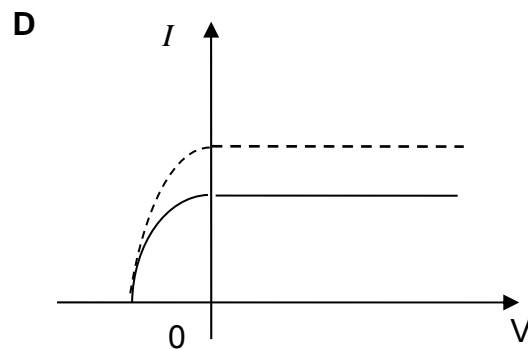
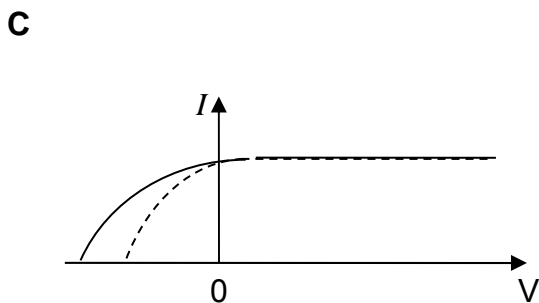
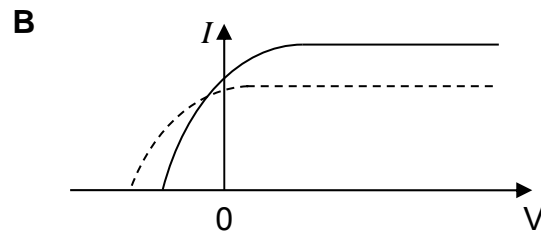
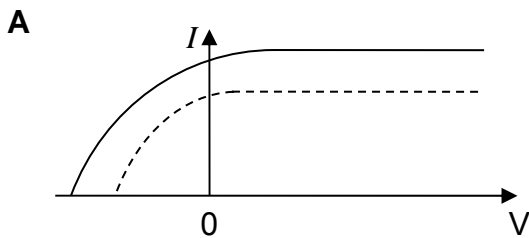

Ans: D

When the intensity is doubled, the rate of incidence is increased, hence the rate of emission of photoelectrons and hence photocurrent is increased. Since the frequency of light does not change, the stopping potential does not change.



SERANGOON JUNIOR COLLEGE
General Certificate of Education Advanced Level
Higher 1

NAME

CG

INDEX NO.

PHYSICS

8866/02

Preliminary Examination
Paper 2 Structured Questions

11th September 2017
2 hours

Candidates answer on the Question Paper.
No Additional Materials are required.

READ THIS INSTRUCTIONS FIRST

Write your name, civics group and index number in the spaces at the top of this page.

Write in dark blue or black pen on both sides of the paper.
You may use HB pencil for any diagrams or graphs.
Do not use staples, paper clips, glue or correction fluid.

The use of an approved scientific calculator is expected, where appropriate.

Answer **all** questions in Section A and any **two** questions in Section B.

At the end of the examination, fasten all your work securely together.
The number of marks is given in bracket [] at the end of each question or part question.

| For Examiners' Use | |
|---------------------------|------|
| Q1 | / 8 |
| Q2 | / 7 |
| Q3 | / 8 |
| Q4 | / 9 |
| Q5 | / 8 |
| Q6 | / 20 |
| Q7 | / 20 |
| Q8 | / 20 |
| Total marks | / 80 |

DATA AND FORMULAE**Data**

| | |
|-------------------------------|---|
| speed of light in free space, | $c = 3.00 \times 10^8 \text{ m s}^{-1}$ |
| elementary charge, | $e = 1.60 \times 10^{-19} \text{ C}$ |
| the Planck constant, | $h = 6.63 \times 10^{-34} \text{ J s}$ |
| unified atomic mass constant, | $u = 1.66 \times 10^{-27} \text{ kg}$ |
| rest mass of electron, | $m_e = 9.11 \times 10^{-31} \text{ kg}$ |
| rest mass of proton, | $m_p = 1.67 \times 10^{-27} \text{ kg}$ |
| acceleration of free fall, | $g = 9.81 \text{ m s}^{-2}$ |

Formulae

| | |
|-------------------------------|-------------------------------|
| uniformly accelerated motion, | $s = ut + \frac{1}{2} at^2$ |
| | $v^2 = u^2 + 2as$ |
| work done on/by a gas, | $W = p\Delta V$ |
| hydrostatic pressure, | $p = \rho gh$ |
| resistors in series, | $R = R_1 + R_2 + \dots$ |
| resistors in parallel, | $1/R = 1/R_1 + 1/R_2 + \dots$ |

Section A

Answer all the questions in this Section.

- 1 In order to determine the value of the gravitational acceleration g , a student throws a ball at a speed of 15 m s^{-1} horizontally from a building.

(a) The student collects the following data for the ball when it reaches the ground.

| Quantity | Value | Absolute Uncertainty |
|-------------------------|-----------|----------------------|
| Vertical displacement | 122.500 m | 0.002 m |
| Horizontal displacement | 75.000 m | 0.002 m |

(i) Show that the time taken to reach the ground is 5.0 s. [1]

(ii) The uncertainty of the time taken is 0.4 s.

Determine the value of g , with its associated uncertainty.

$$g = \dots\dots\dots \pm \dots\dots\dots \text{ m s}^{-2} \text{ [3]}$$

- (b) In the absence of air resistance, the variation of the vertical speed v of the ball with time t is shown in Fig. 1.1.

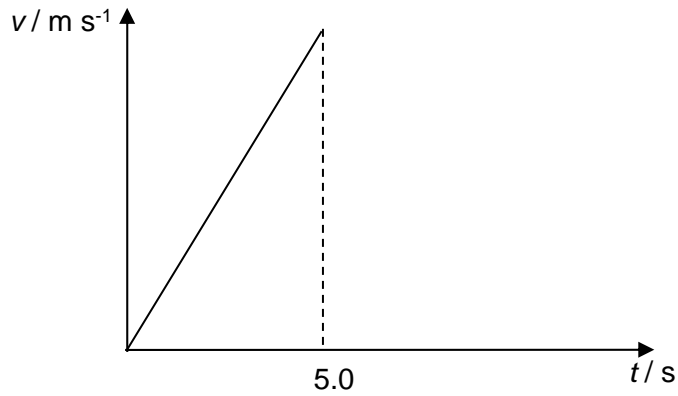

Fig. 1.1

- (i) In reality, there is air resistance. Sketch the graph of variation of vertical speed with time on Fig. 1.1, and label this graph Z. [2]
- (ii) Explain the shape of the graph Z.

.....

.....

.....

..... [2]

- 2 A uniform rod of weight 20 N is freely hinged to a wall at P as shown in Fig.2.1. It is held horizontal by an elastic cord made of material X of force constant 10 N cm^{-1} , attached at Q at an angle of 15° to the rod.

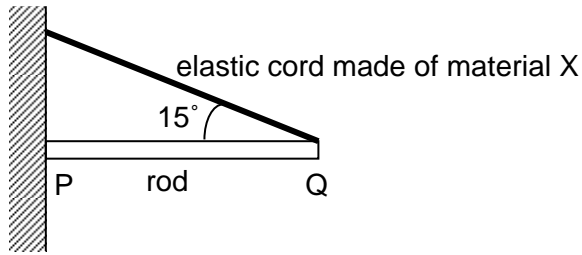

Fig.2.1

- (a) Show the extension of the elastic cord is 3.86 cm. [2]

- (b) Determine the magnitude of the resultant force acting at P.

magnitude of resultant force at P = N [3]

- (c) The elastic cord X is now replaced by two other identical elastic cords of the same unstretched length as elastic cord X. These two elastic cords are connected in parallel. The rod PQ remains horizontal. State and explain the value of the force constant of each of the new elastic cords.

.....

 [2]

- 3 Fig. 3.1 shows the cross-section of two long straight wires X and Y perpendicular to the page, placed at a distance of 3.0 cm apart. There is an electric current in both wires out of the page. The current in wires X and Y are 1.0 A and 2.0 A respectively.

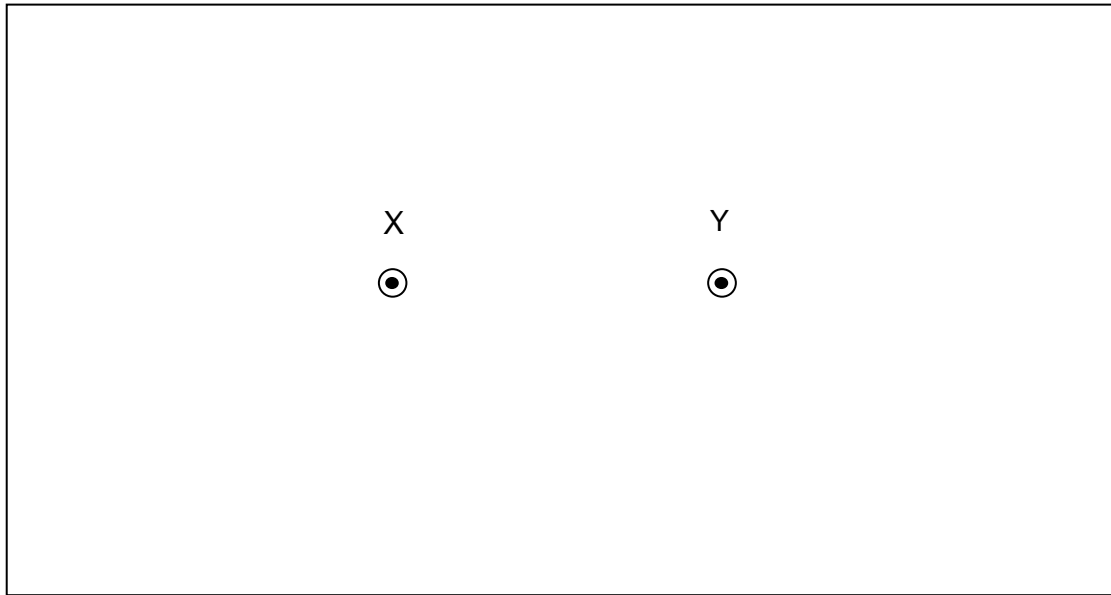

Fig. 3.1

- (a) Sketch the resultant magnetic field pattern around the wires. Include direction arrows on the field lines. [3]
- (b) Each wire exerts a force on the other wire. Draw one arrow on each wire to show the direction of these forces. [1]
- (c) For a straight current-carrying conductor, the magnetic flux density B at a distance r from the conductor is given by the relation

$$B = (2.0 \times 10^{-7}) \frac{I}{r}$$

where I is the current flowing in the conductor.

Determine the magnetic flux density experienced by wire Y due to the current flowing in wire X.

magnetic flux density = T [2]

- (d) Hence, determine the magnitude of the force per unit length between the wires.

force per unit length = N m⁻¹ [2]

- 4 (a) By reference to the photoelectric effect, explain why, even when the incident light is monochromatic, the emitted electrons have a range of kinetic energies up to a maximum value.

.....

.....

.....

.....

.....

..... [2]

- (b) In an experiment to investigate the photoelectric effect, a student measures the wavelength λ of the light incident on a metal surface, and the maximum kinetic energy E_{max} of $1/\lambda$ as shown in Fig. 4.1.

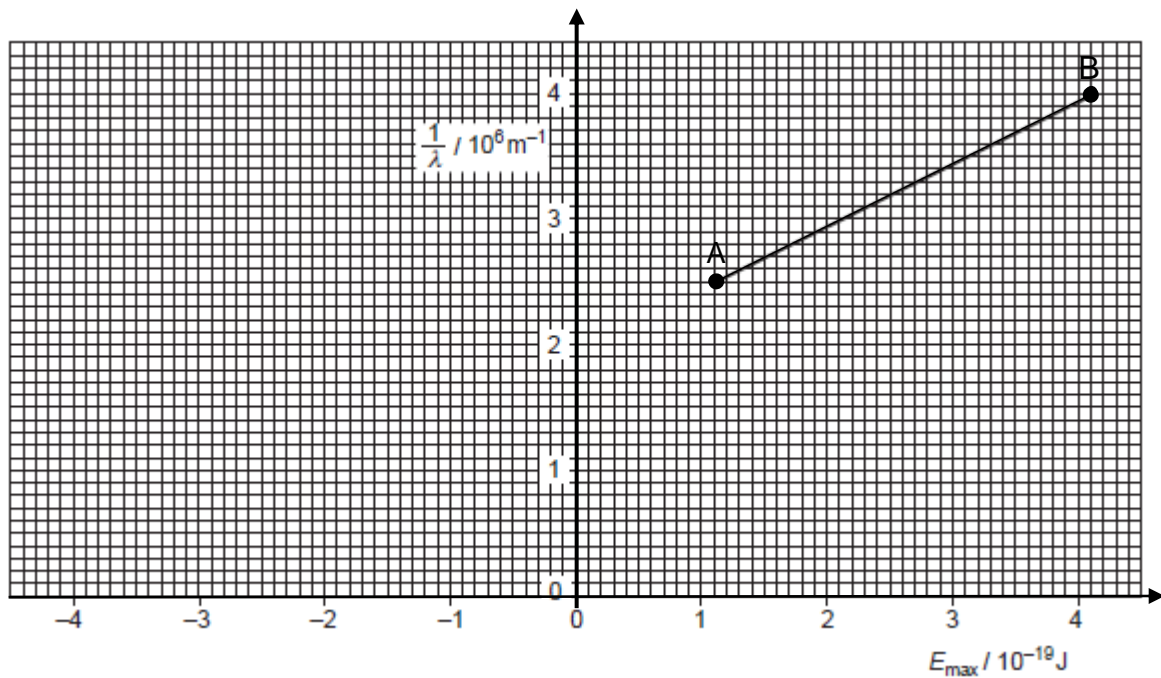

Fig. 4.1

- (i) Without using the value of the Planck constant, determine the work function of the metal surface.

work function = J [2]

- (ii) Using points A and B, determine the Planck constant.

Planck constant = J s [3]

- (c) White light in a beam is incident on some cool hydrogen gas as shown in Fig. 4.2.

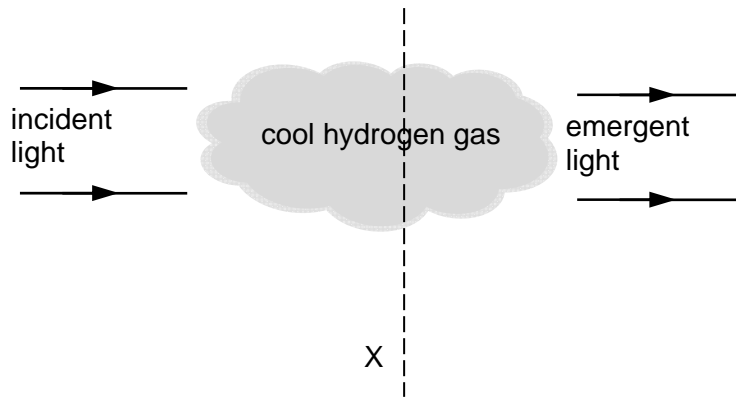

Fig. 4.2

Describe and explain the appearance of the spectrum viewed from position X.

.....

.....

..... [2]

- 5 A capacitor is an electrical device which can store charges and energy. A simple parallel plate capacitor consists of two parallel conducting plates separated by an insulator, as shown in Fig. 5.1.

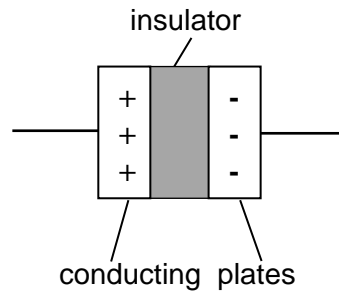

Fig. 5.1

When charged, the two plates carry opposite charges of the same magnitude. The relationship between the amount of charge stored Q , the potential difference V between the plates and the capacitance C is given by the equation

$$Q = CV$$

The capacitor is now charged. Fig. 5.2 shows the variation of the amount of charge Q with the potential difference V between the plates.

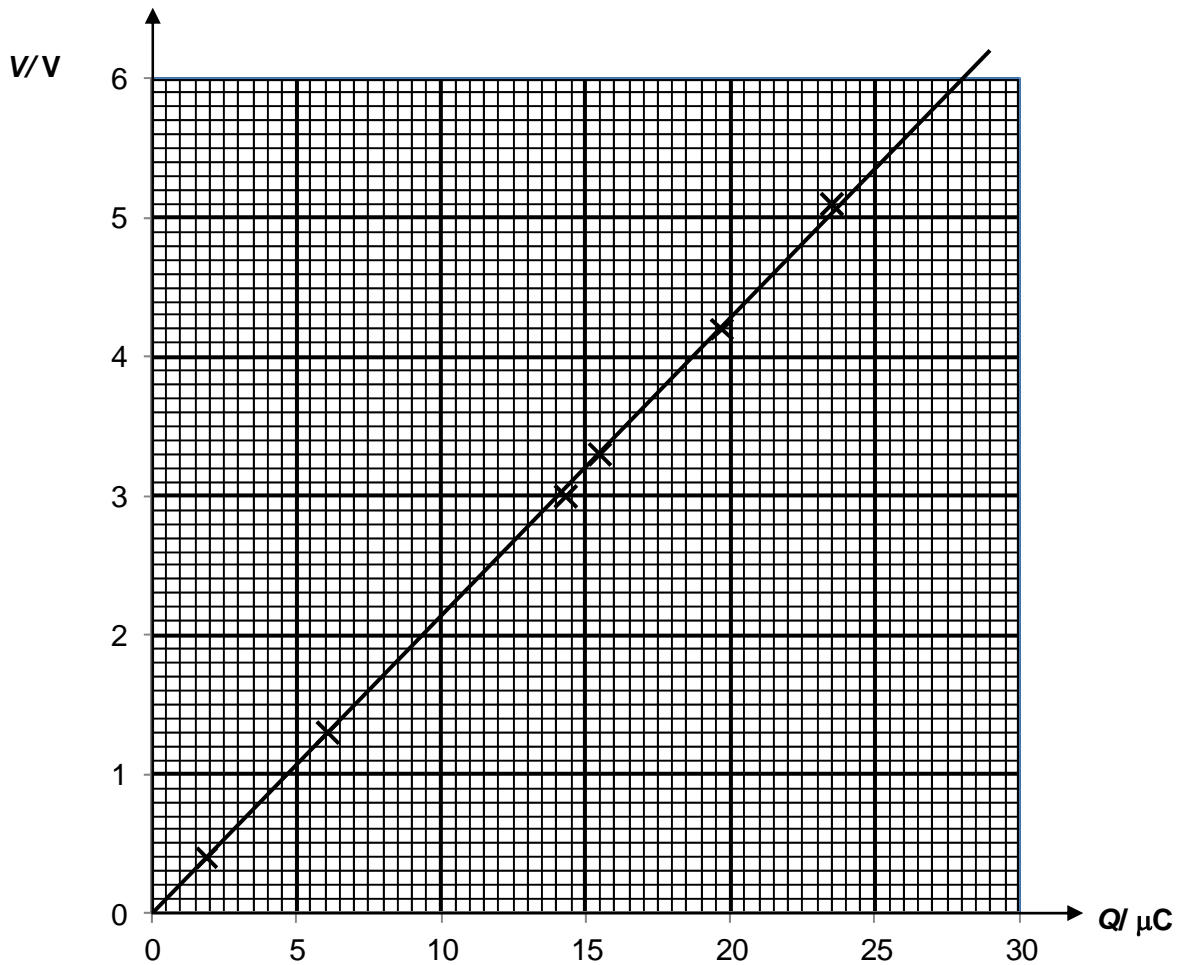

Fig. 5.2

- (a) State the quantity represented by the gradient of the graph.

..... [1]

- (b) The capacitor is now discharged by connecting it across a resistor of resistance R as shown in Fig. 5.3.

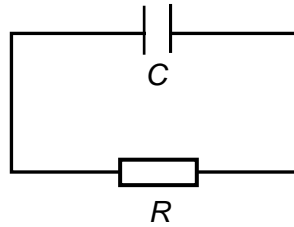

Fig. 5.3

Fig. 5.4 shows the variation with time t of the potential difference V across the resistor.

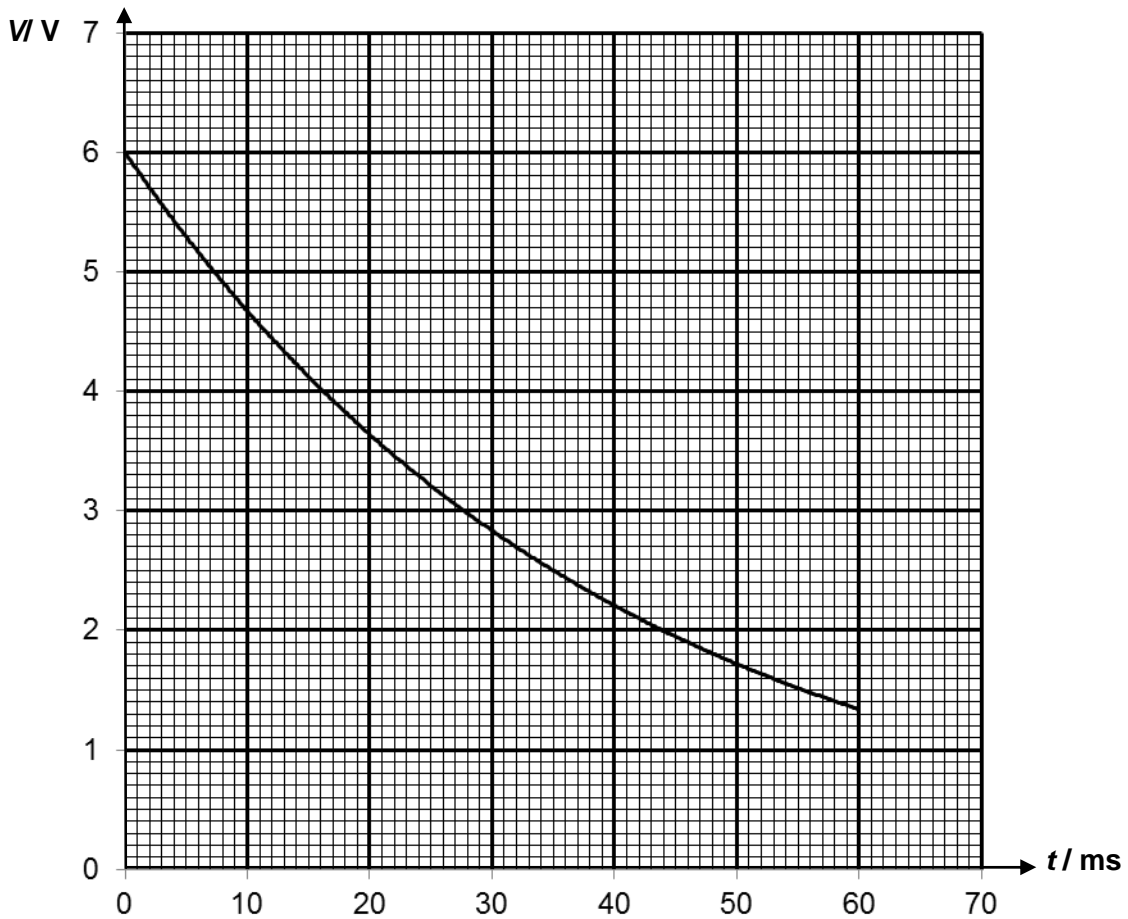

Fig. 5.4

- (i) Using Fig. 5.2 and Fig. 5.4, determine the initial amount of charge stored.

charge = μC [2]

- (ii) Hence, calculate the capacitance C .

capacitance = C V^{-1} [2]

- (iii) The energy E stored in a capacitor is $\frac{1}{2} CV^2$.
Calculate the energy lost when the capacitor has been discharged for 45 ms.

energy lost = J [3]

Section B
Answer two questions from this Section.

6 (a) State Newton's second law of motion.

.....
.....
..... [2]

(b) Two blocks, R and S, of masses 0.30 kg and 1.50 kg respectively, are connected by a string that passes over a pulley as shown in Fig. 6.1. The pulley is frictionless and the string is inelastic. The system is released from rest. Block S falls vertically before it strikes a spring that is firmly attached to the floor. The spring constant of the spring is 500 N m⁻¹.

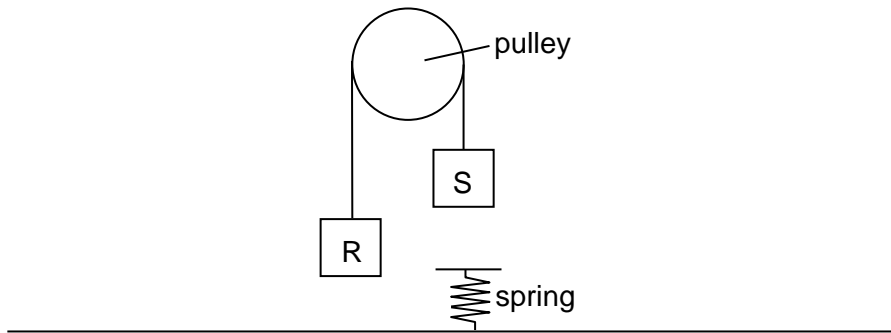

Fig. 6.1

(i) Draw the labelled free-body diagrams of Blocks R and S at the instant when the system is released from rest. [2]

(ii) Determine the magnitude of the acceleration of Block S before striking the spring.

magnitude of acceleration = m s⁻² [3]

(iii) The acceleration of Block S decreases after it touches the spring. Block S comes to a stop after some time and the spring is observed to be compressed.

1. By considering the free body diagrams of both blocks at equilibrium, show that the maximum compression of the spring is 0.0235 m. [2]

2. Hence, explain how the maximum compression would change if a spring of smaller spring constant is used.

.....
.....
.....
..... [2]

(iv) Sketch on Fig. 6.2 for Block S, the variation with the distance from the point of release of its

1. gravitational potential energy (label the graph G),
2. elastic potential energy (label the graph E),
3. kinetic energy (label the graph K). [3]

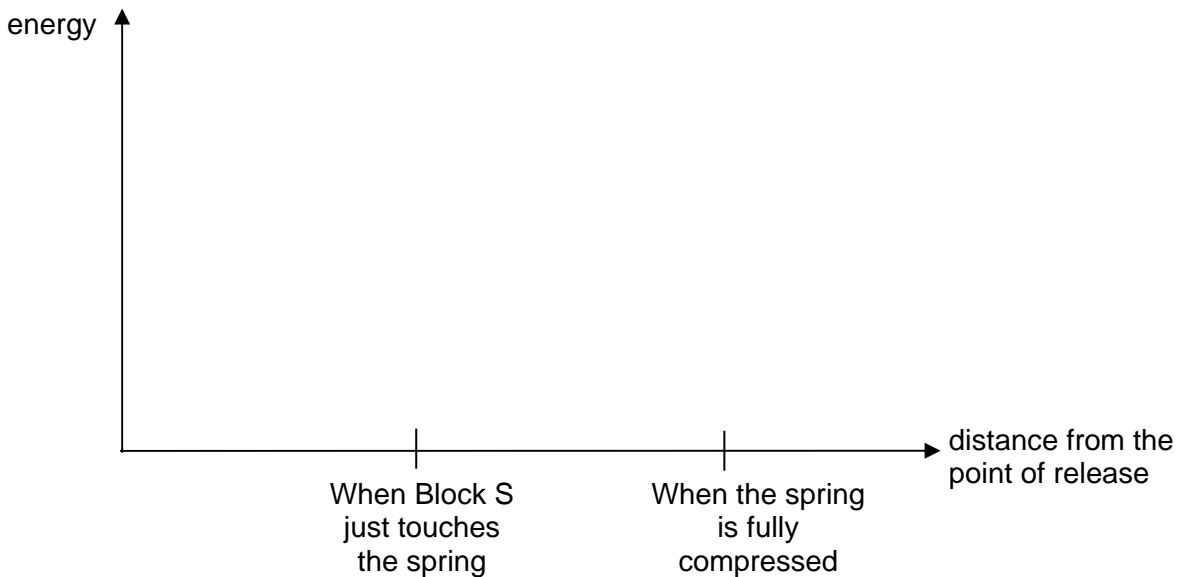

Fig. 6.2

- (c) Truck X of mass 22 000 kg and moving at a speed of 3.0 m s^{-1} , catches up and collides with Truck Y moving at 1.0 m s^{-1} moving in the same direction as shown in Fig. 6.3.

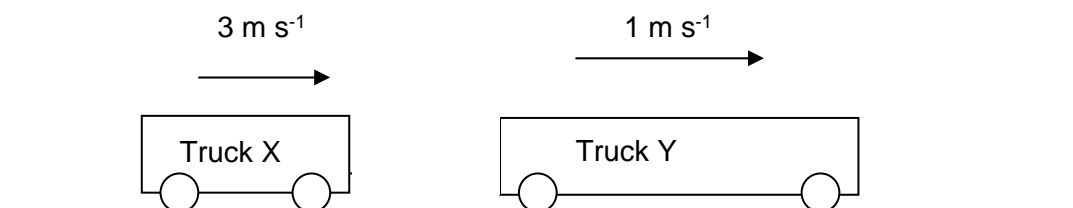

Fig. 6.3

Fig. 6.3 shows the variation of speeds v of the trucks with time t before, during and after the collision.

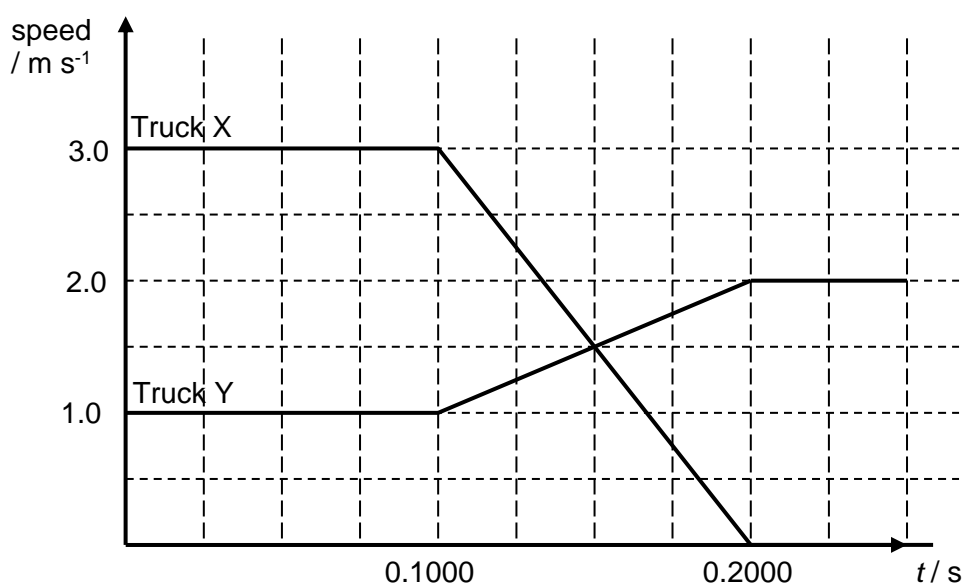

Fig. 6.3

- (i) Using Fig. 6.3, show that the mass of Truck Y is 66000 kg. [2]
- (ii) Show that the collision is elastic. [1]

- (iii) 1. Calculate the magnitude of the impulse exerted by Truck X on Truck Y.

magnitude of the impulse = N s [2]

2. If the duration of collision is reduced, with the initial and final speeds of both trucks unchanged, state and explain how this affects your answer in 1.

.....

..... [1]

7 (a) State what is meant by *coherent sources*.

.....

 [2]

(b) Fig. 7.1 below shows a progressive wave displayed on a cathode ray oscilloscope (c.r.o.). Sketch on Fig. 7.1 one cycle of a wave that has a phase difference of $\frac{\pi}{2}$ radians with the progressive wave.
 with the progressive wave.

[2]

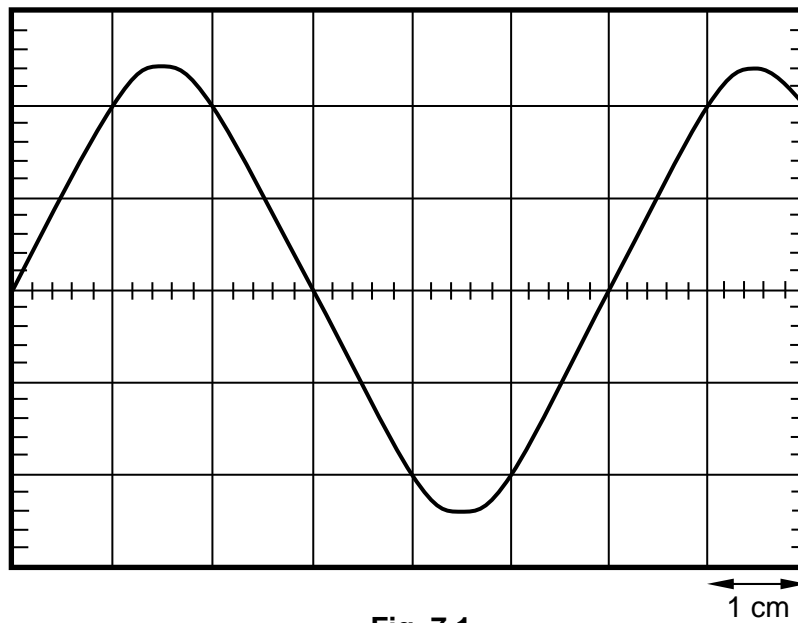

Fig. 7.1

- (c) A stereo system in a large hall has two identical speakers, S_1 and S_2 , placed 1.2 m apart as shown in Fig. 7.2. The amplitude of the output of each speaker is proportional to the potential difference across its terminals, which is adjusted by means of a balance control.

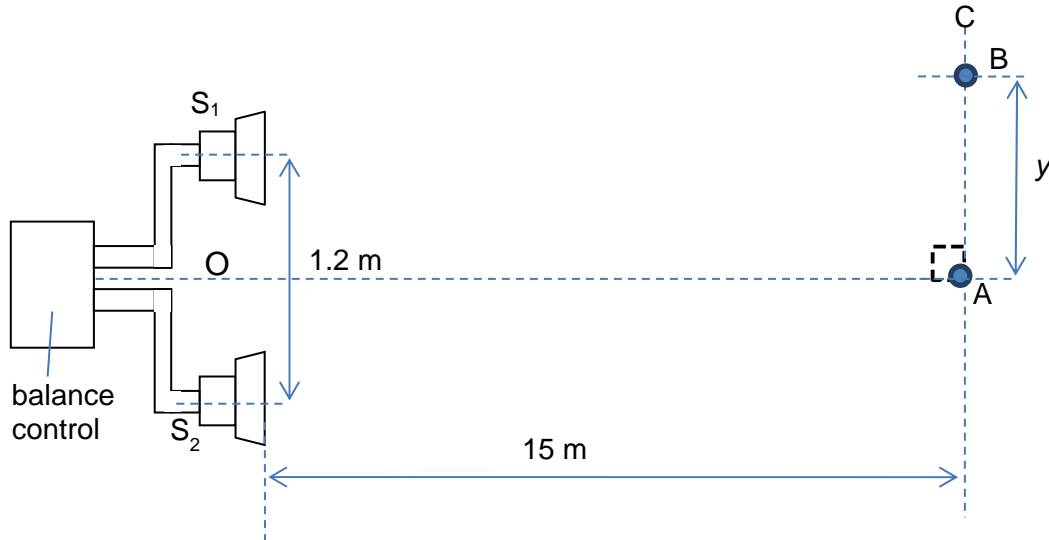

Fig. 7.2 (not to scale)

Initially, the speakers are emitting signals of frequency 1000 Hz which are in phase. The balance control is set such that the potential difference across the terminals of both speakers are the same.

Line AC is 15 m away from the speakers. An observer hears a loud sound of intensity I_{\max} at A. As he moves along the line AC, 15 m away from the speakers, he observes that the intensity of the sound first falls to zero at point B, a distance y from A. The speed of sound in air is 330 m s^{-1} .

- (i) Using Young's Double Slit formula, determine the distance between adjacent positions of loud sounds.

distance = m [3]

- (ii) Hence, show that the distance y is 2.1 m. [1]

- (iii) The balance control is now adjusted such that the amplitude of the signal from S_1 is reduced while the amplitude of the signal from S_2 is unchanged.

Suggest and explain any changes to the sound heard at B.

.....

.....

.....

..... [2]

- (iv) State the effect on the interference pattern along the line AC when the distance between the two speakers is decreased.

.....

.....

..... [1]

- (d) Fig. 7.3 shows a string stretched between two fixed points P and Q.

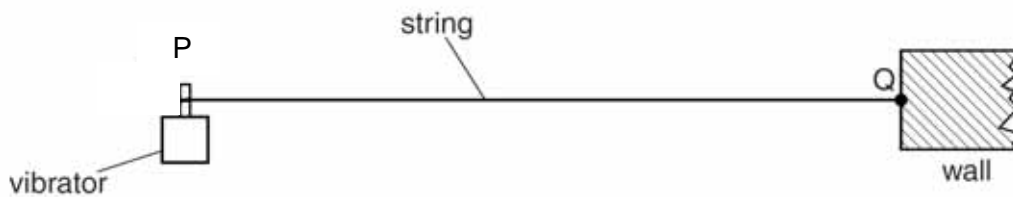

Fig. 7.3

A vibrator is attached at end P of the string. End Q is fixed to a wall. The stationary wave produced on PQ at one instant of time t is shown on Fig. 7.4. Each point on the string is at its maximum displacement.

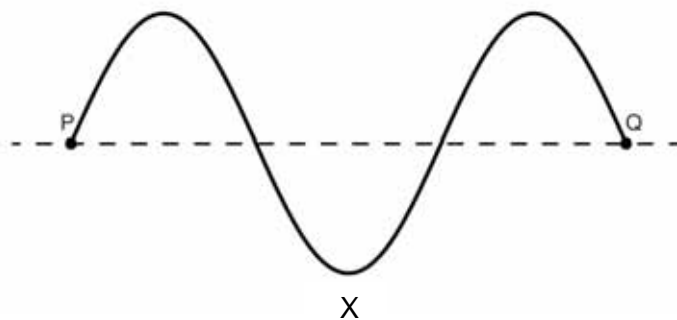

Fig. 7.4

- (i) Explain how this arrangement may produce a stationary wave on the string.

.....

 [2]

- (ii) It takes 0.01 s for the point X on the string to reach the highest point of its oscillation.

Calculate the frequency of the vibrator.

frequency = Hz [2]

- (iii) The length of PQ is 1.2 m. Determine the wavelength of the stationary wave.

wavelength = m [2]

- (iv) Hence, show that the speed of the stationary wave is 40 m s^{-1} . [1]

- (v) Draw on Fig. 7.4 the stationary wave when the frequency of the vibrator is doubled while keeping the speed of the wave constant. [2]

8 (a) A household electric lamp is rated as 240V, 40W. The filament lamp is made from tungsten wire of radius 5.0×10^{-6} m. The resistivity of tungsten at the normal operating temperature of the lamp is $7.9 \times 10^{-7} \Omega\text{m}$.

(i) For the lamp at its normal operating condition, show that the resistance of the filament is 1440 Ω .

[1]

(ii) Calculate the length of the filament.

length = m [3]

(iii) Comment on your answer in (ii).

.....

..... [2]

- (b) An electric heater consists of three similar heating elements A, B, C, connected as shown in Fig. 8.1.

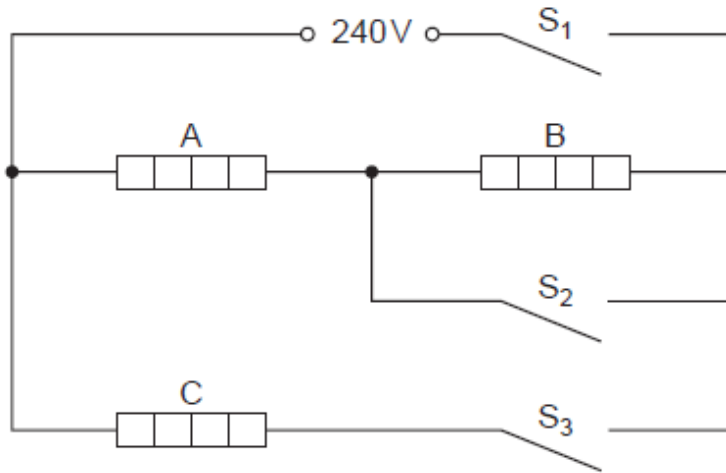

Fig. 8.1

Each heating element is rated as 1.5kW, 240V and may be assumed to have constant resistance.

The circuit is connected to a 240 V supply.

The switches S_1 , S_2 and S_3 may be either open or closed.

- (i) When S_1 , S_2 and S_3 are all closed, state the total power dissipation of the heater.

total power dissipation = kW [1]

- (ii) When S_1 is closed, S_2 is open, and S_3 is open, show that the total power dissipation of the heater is 0.75 kW. [2]

- (iii) Hence, determine the total power dissipation of the heater when S_1 is closed, S_2 is open, and S_3 is closed.

total power dissipation = kW [1]

- (c) On Fig. 8.2, sketch the temperature characteristic of a thermistor.

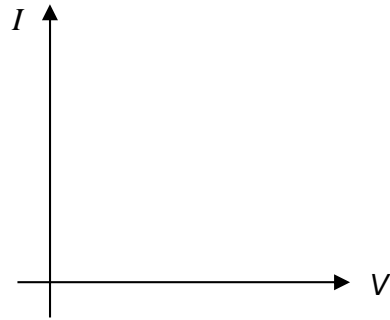

Fig. 8.2

[1]

- (d) A potential divider circuit is shown in Fig. 8.3.

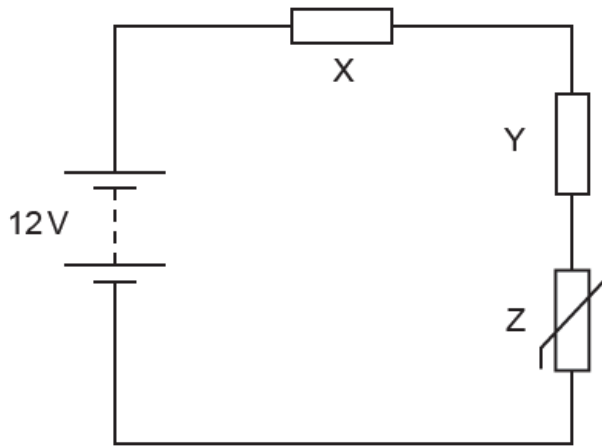

Fig. 8.3

The battery of electromotive force (e.m.f.) 12 V and negligible internal resistance is connected in series with resistors X and Y and thermistor Z. The resistance of Y is 15 kΩ and the resistance of Z at a particular temperature is 3.0 kΩ. The potential difference (p.d.) across Y is 8.0 V.

- (i) By reference to the circuit shown in Fig. 8.3, distinguish between the definitions of e.m.f. and p.d.

.....

.....

.....

..... [2]

(ii) Calculate the current in the circuit.

current = A [2]

(iii) Calculate the resistance of X.

resistance = Ω [3]

(iv) The temperature of Z is decreased.
State and explain the effect of this on the potential difference across Z.

.....
.....
.....
..... [2]

END OF PAPER



SERANGOON JUNIOR COLLEGE
General Certificate of Education Advanced Level
Higher 1

NAME

CG

INDEX NO.

PHYSICS

8866/02

Preliminary Examination
Paper 2 Structured Questions

11th September 2017
2 hours

Candidates answer on the Question Paper.
No Additional Materials are required.

READ THIS INSTRUCTIONS FIRST

Write your name, civics group and index number in the spaces at the top of this page.

Write in dark blue or black pen on both sides of the paper.
You may use HB pencil for any diagrams or graphs.
Do not use staples, paper clips, glue or correction fluid.

The use of an approved scientific calculator is expected, where appropriate.

Answer **all** questions in Section A and any **two** questions in Section B.

At the end of the examination, fasten all your work securely together.
The number of marks is given in bracket [] at the end of each question or part question.

| For Examiners' Use | |
|---------------------------|------|
| Q1 | / 8 |
| Q2 | / 7 |
| Q3 | / 8 |
| Q4 | / 9 |
| Q5 | / 8 |
| Q6 | / 20 |
| Q7 | / 20 |
| Q8 | / 20 |
| Total marks | / 80 |

DATA AND FORMULAE**Data**

| | |
|-------------------------------|---|
| speed of light in free space, | $c = 3.00 \times 10^8 \text{ m s}^{-1}$ |
| elementary charge, | $e = 1.60 \times 10^{-19} \text{ C}$ |
| the Planck constant, | $h = 6.63 \times 10^{-34} \text{ J s}$ |
| unified atomic mass constant, | $u = 1.66 \times 10^{-27} \text{ kg}$ |
| rest mass of electron, | $m_e = 9.11 \times 10^{-31} \text{ kg}$ |
| rest mass of proton, | $m_p = 1.67 \times 10^{-27} \text{ kg}$ |
| acceleration of free fall, | $g = 9.81 \text{ m s}^{-2}$ |

Formulae

| | |
|-------------------------------|-------------------------------|
| uniformly accelerated motion, | $s = ut + \frac{1}{2} at^2$ |
| | $v^2 = u^2 + 2as$ |
| work done on/by a gas, | $W = p\Delta V$ |
| hydrostatic pressure, | $p = \rho gh$ |
| resistors in series, | $R = R_1 + R_2 + \dots$ |
| resistors in parallel, | $1/R = 1/R_1 + 1/R_2 + \dots$ |

Section A

Answer all the questions in this Section.

- 1 In order to determine the value of the gravitational acceleration g , a student throws a ball at a speed of 15 m s^{-1} horizontally from a building.

(a) The student collects the following data for the ball when it reaches the ground.

| Quantity | Value | Absolute Uncertainty |
|-------------------------|-----------|----------------------|
| Vertical displacement | 122.500 m | 0.002 m |
| Horizontal displacement | 75.000 m | 0.002 m |

- (i) Show that the time taken to reach the ground is 5.0 s. [1]

Consider the horizontal direction,

$$s_x = u_x t$$

$$t = \frac{75.0}{15} \quad [\text{M1}]$$

$$= 5.0 \text{ s}$$

- (ii) The uncertainty of the time taken is 0.4 s.

Determine the value of g , with its associated uncertainty.

Consider the vertical direction,

$$s_y = u_y t + \frac{1}{2} g t^2 = \frac{1}{2} g t^2$$

$$g = \frac{2s_y}{t^2} = \frac{2(122.5)}{5.0^2} = 9.80 \text{ m s}^{-2} \quad [\text{M1}]$$

$$\frac{\Delta g}{g} = \frac{\Delta s_y}{s_y} + 2 \frac{\Delta t}{t} = \frac{0.002}{122.5} + 2 \left(\frac{0.4}{5.0} \right) \quad [\text{M1}]$$

$$\Delta g = 2 \text{ m s}^{-2} \text{ (1 s.f.)}$$

$$g \pm \Delta g = (10 \pm 2) \text{ m s}^{-2} \quad [\text{A1}]$$

$$g = \dots \pm \dots \text{ m s}^{-2} \quad [3]$$

- (b) In the absence of air resistance, the variation of the vertical speed v of the ball with time t is shown in Fig. 1.1.

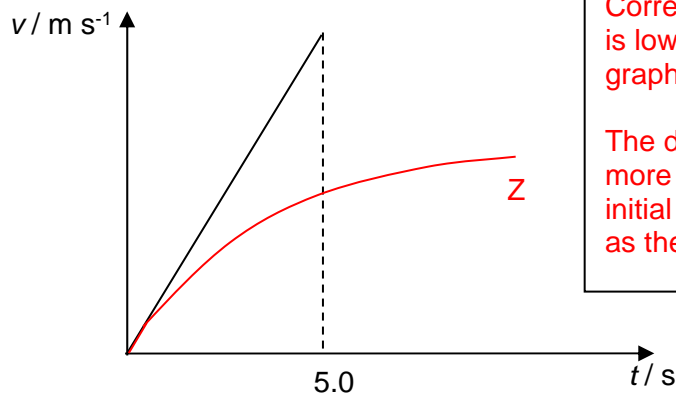

Correct shape – a curve that is lower than the original graph [B1]

The duration of motion is more than 5.0 s, and the initial gradient is the same as the original graph [B1]

Fig. 1.1

- (i) In reality, there is air resistance. Sketch the graph of variation of vertical speed with time on Fig. 1.1, and label this graph Z. [2]
- (ii) Explain the shape of the graph Z.

As the ball falls downwards, its speed increases and therefore upward air resistance acting on it also increases. [B1]
 The net force acting on the ball decreases, therefore the acceleration decreases, resulting in the gradient of graph Z being gentler than that of the original graph. [B1]

[2]

- 2 A uniform rod of weight 20 N is freely hinged to a wall at P as shown in Fig.2.1. It is held horizontal by an elastic cord made of material X of force constant 10 N cm^{-1} , attached at Q at an angle of 15° to the rod.

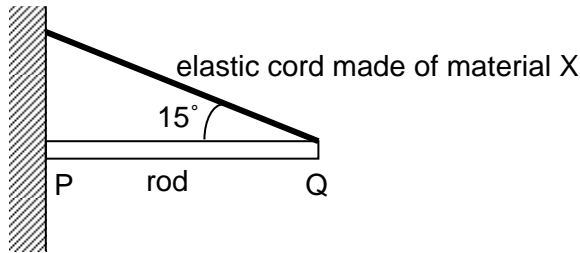

Fig.2.1

- (a) Show the extension of the elastic cord is 3.86 cm. [2]

Let L be the length of the rod and x be the extension of elastic cord.
 Using Principle of Moments, taking moments about point P
 Sum of clockwise moment = Sum of anticlockwise moment
 Or
 $W (0.5 L) = (T \sin 15^\circ) L$ [B1]
 $20 (0.5 L) = (10x \sin 15^\circ) L$ [B1]
 $x = 3.86 \text{ cm}$

- (b) Determine the magnitude of the resultant force acting at P.

Consider vertical forces
 Taking upwards positive
 $T \sin 15^\circ + R_2 + (-W) = 0$
 $38.6 \sin 15^\circ + R_2 + (-20) = 0$ [M1]
 $R_2 = 10.0 \text{ N}$

Consider horizontal forces
 Taking rightward positive
 $R_1 + (-T \cos 15^\circ) = 0$
 $R_1 + (-38.6 \cos 15^\circ) = 0$ [M1]
 $R_1 = 37.3 \text{ N}$

$R = \sqrt{R_1^2 + R_2^2} = \sqrt{10.0^2 + 37.3^2} = 38.6 \text{ N}$ [A1]

magnitude of resultant force at P = N [3]

- (c) The elastic cord X is now replaced by two other identical elastic cords of the same unstretched length as elastic cord X. These two elastic cords are connected in parallel. The rod PQ remains horizontal. State and explain the value of the force constant of each of the new elastic cords.

Each elastic cord experiences half of the tension as that in elastic cord X. Since the extension of each cord is the same as that of elastic cord to keep rod PQ horizontal [M1], therefore the force constant of each of the new cord is 5 N cm^{-1} . [A1]
OR
 Since the elastic cords are connected in parallel, their effective force constant is same as that of elastic cord X, and the effective force constant is the sum of the force constants of the two cords [M1]. The force constant of each of the new cord is 5 N cm^{-1} . [A1]

- 3 Fig. 3.1 shows the cross-section of two long straight wires X and Y perpendicular to the page, placed at a distance of 3.0 cm apart. There is an electric current in both wires out of the page. The current in wires X and Y are 1.0 A and 2.0 A respectively.

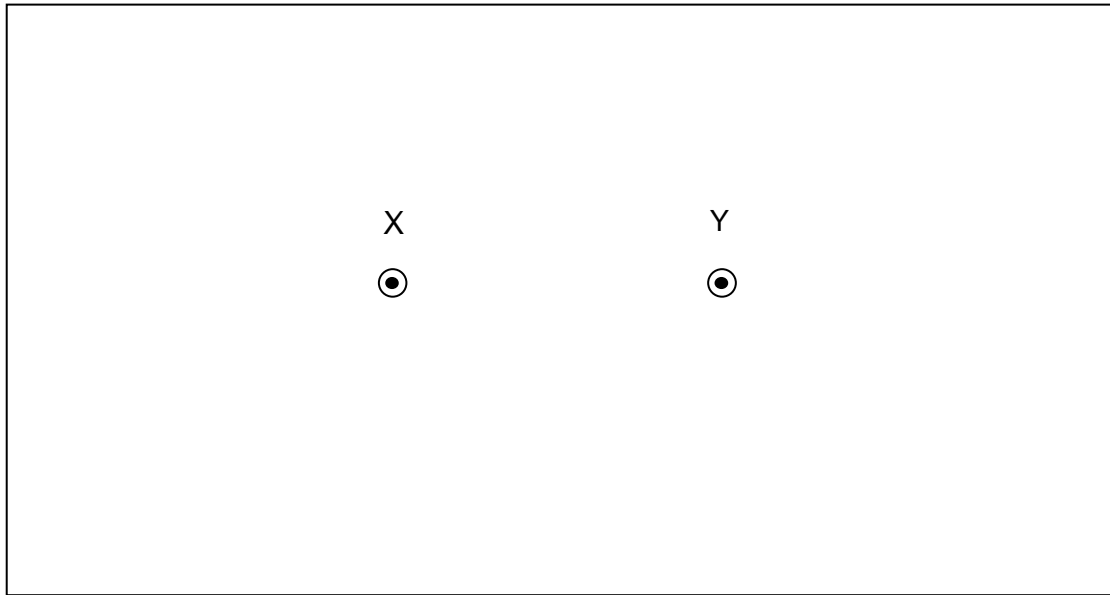

Fig. 3.1

- (a) Sketch the resultant magnetic field pattern around the wires. Include direction arrows on the field lines. [3]

[B1]: Magnetic field lines are anti-clockwise.

[B1]: Magnetic field lines are closer together around Y compared to around X.

[B1]: Neutral point is closer to X than Y.

- (b) Each wire exerts a force on the other wire. Draw one arrow on each wire to show the direction of these forces. [1]

[B1]: Force on X to right, force on Y to the left. Arrows should be of the same length. .

- (c) For a straight current-carrying conductor, the magnetic flux density B at a distance r from the conductor is given by the relation

$$B = (2.0 \times 10^{-7}) \frac{I}{r}$$

where I is the current flowing in the conductor.

Determine the magnetic flux density experienced by wire Y due to the current flowing in wire X.

$$B = \frac{(2 \times 10^{-7})(1.0)}{0.03} \text{ [M1 substitution] [A1 answer]}$$

$$= 6.67 \times 10^{-5} \text{ T}$$

magnetic flux density = T [2]

- (d) Hence, determine the magnitude of the force per unit length between the wires.

$$F = BIL$$
$$\frac{F}{L} = BI = (4.19 \times 10^{-5})(2.0) \text{ [M1 formula] [A1 substitution and answer]}$$
$$= 1.33 \times 10^{-5} \text{ Nm}^{-1}$$

force per unit length = N m⁻¹ [2]

- 4 (a) By reference to the photoelectric effect, explain why, even when the incident light is monochromatic, the emitted electrons have a range of kinetic energies up to a maximum value.

..... There is a range of kinetic energies depending on the location of the electrons with electrons that are on the surface being emitted with the maximum kinetic energy. [B1]
 KE can be lower than the maximum energy because electrons that are deeper in the metal lose energy when they collide with other electrons or the lattice ions as they make their way to the surface. [B1]

.....[2]

- (b) In an experiment to investigate the photoelectric effect, a student measures the wavelength λ of the light incident on a metal surface, and the maximum kinetic energy E_{max} of $1/\lambda$ as shown in Fig. 4.1.

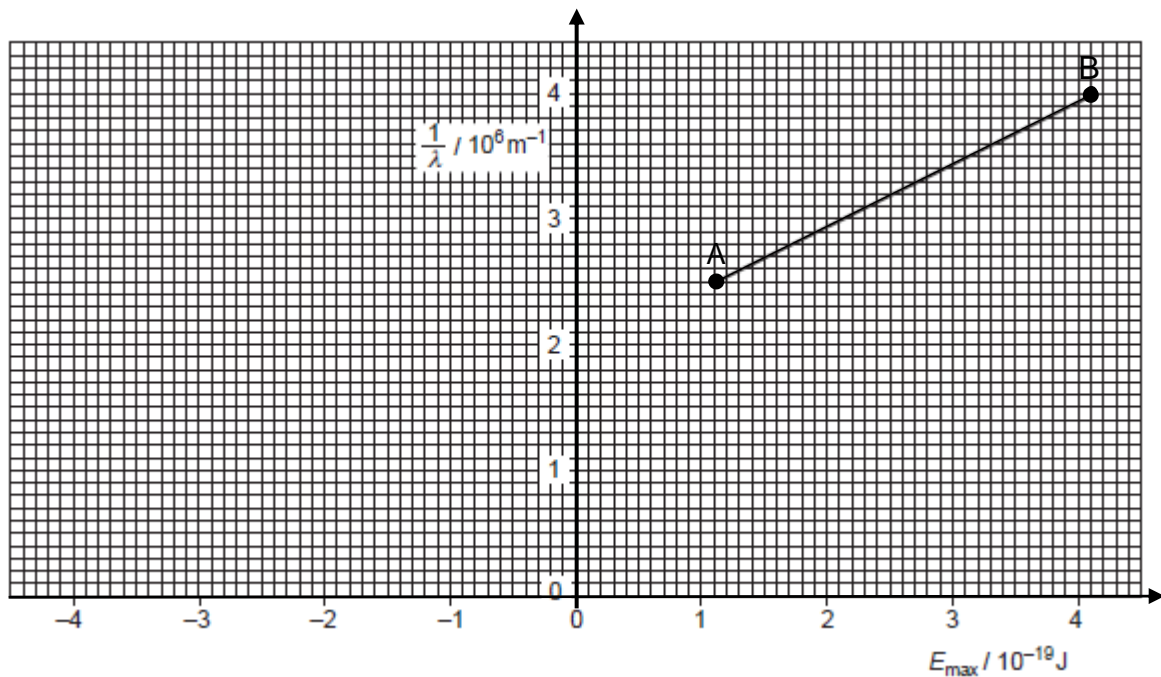

Fig. 4.1

- (i) Without using the value of the Planck constant, determine the work function of the metal surface.

$$hc/\lambda = \Phi + E_{max}$$

$$1/\lambda = \Phi/hc + E_{max}/hc$$

At x-intercept, $\Phi = - E_{max}$

Either extend line to intersect on x-axis [M1]
Or form eqn of straight line to solve [M1]
 $\Phi = 4.0 \times 10^{19} \text{ J}$ (allow $\pm 0.2 \times 10^{19} \text{ J}$) [A1]

work function = J [2]

- (ii) Using points A and B, determine the Planck constant.

Gradient of line = $1/hc$ [M1]
 Gradient = $\frac{(4.00 - 2.80) \times 10^6}{(4.10 - 1.10) \times 10^{-19}} = 5.00 \times 10^{24}$
 Correct coordinates of points to half a square and correct calculation of gradient [M1]
 $h = 1/(c \times \text{gradient})$
 $= 1/(3.0 \times 10^8 \times 5.00 \times 10^{24})$
 $= 6.67 \times 10^{-34} \text{ Js}$ [A1]

Planck constant = J s [3]

(c) White light in a beam is incident on some cool hydrogen gas as shown in Fig. 4.2.

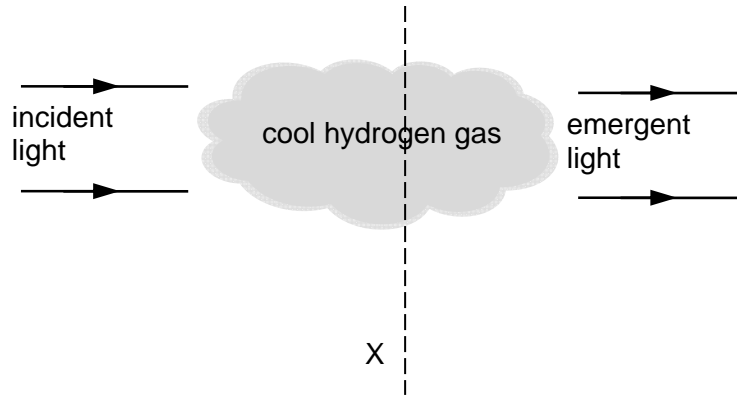

Fig. 4.2

Describe and explain the appearance of the spectrum viewed from position X.

.....

[B1] Coloured lines against dark background
[B1] Spectrum exists because when the electrons in the gas de-excite to lower energy levels, the gas atoms emit photons of energies corresponding to the difference between the initial and final energy levels in all directions.

.....
.....
.....
..... [2]

- 5 A capacitor is an electrical device which can store charges and energy. A simple parallel plate capacitor consists of two parallel conducting plates separated by an insulator, as shown in Fig. 5.1.

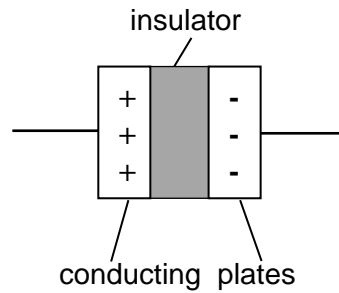

Fig. 5.1

When charged, the two plates carry opposite charges of the same magnitude. The relationship between the amount of charge stored Q , the potential difference V between the plates and the capacitance C is given by the equation

$$Q = CV$$

The capacitor is now charged. Fig. 5.2 shows the variation of the amount of charge Q with the potential difference V between the plates.

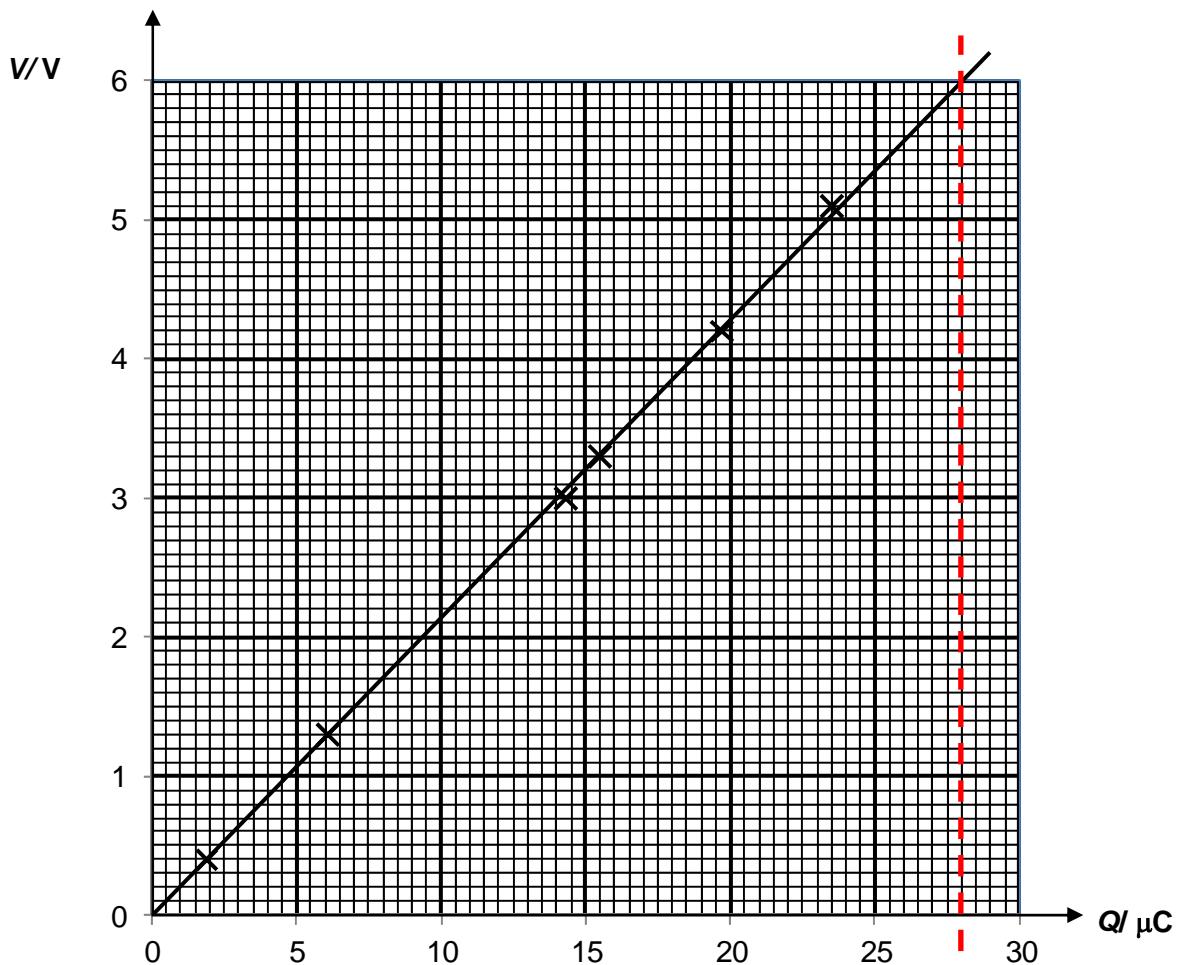

Fig. 5.2

(a) State the quantity represented by the gradient of the graph.

1/C or reciprocal of capacitance C [1]

(b) The capacitor is now discharged by connecting it across a resistor of resistance R as shown in Fig. 5.3.

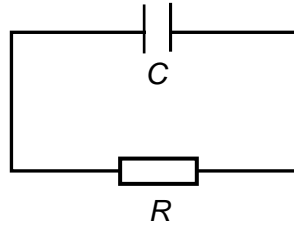

Fig. 5.3

Fig. 5.4 shows the variation with time t of the potential difference V across the resistor.

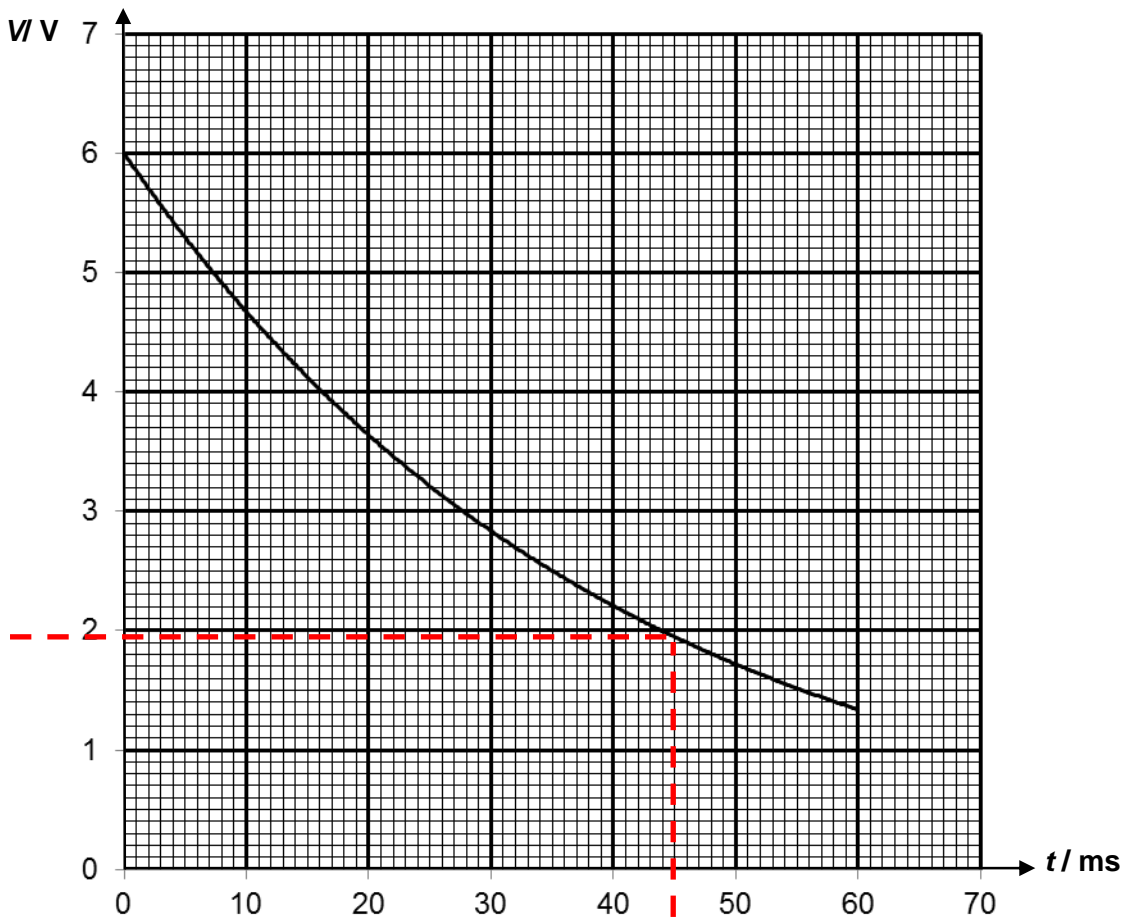

Fig. 5.4

- (i) Using Fig. 5.2 and Fig. 5.4, determine the initial amount of charge stored.

From Fig 5.4, at $t = 0$, $V = 6.00$ V [M1]

From Fig 5.2, read off best fit line. At 6.00 V, $Q = 28.00$ μC [A1]

-1m overall for wrong d.p.

charge = μC [2]

- (ii) Hence, calculate the capacitance C .

$$\begin{aligned} Q &= CV \\ C &= Q/V \\ &= 28.00 \times 10^{-6} / 6.00 \quad [\text{M1}] \\ &= 4.67 \times 10^{-6} \text{ C V}^{-1} \quad [\text{A1}] \end{aligned}$$

capacitance = C V^{-1} [2]

- (iii) The energy E stored in a capacitor is $\frac{1}{2} CV^2$.
Calculate the energy lost when the capacitor has been discharged for 45 ms.

At 45 ms, $V = 1.95$ V [M1]

$$\begin{aligned} \text{Energy lost} &= \frac{1}{2} C (V_i^2 - V_f^2) \quad [\text{M1}] \\ &= \frac{1}{2} (4.67 \times 10^{-6}) (6.00^2 - 1.95^2) \\ &= 7.52 \times 10^{-5} \text{ J} \quad [\text{A1}] \end{aligned}$$

-1m overall for wrong d.p.

energy lost = J [3]

Section B
Answer two questions from this Section.

- 6 (a) State Newton's second law of motion.

Newton's 2nd Law states that the rate of change of momentum of a body is directly proportional to the resultant force acting on it [B1], and the change of momentum takes place in the direction of the resultant force. [B1]

[2]

- (b) Two blocks, R and S, of masses 0.30 kg and 1.50 kg respectively, are connected by a string that passes over a pulley as shown in Fig. 6.1. The pulley is frictionless and the string is inelastic. The system is released from rest. Block S falls vertically before it strikes a spring that is firmly attached to the floor. The spring constant of the spring is 500 N m^{-1} .

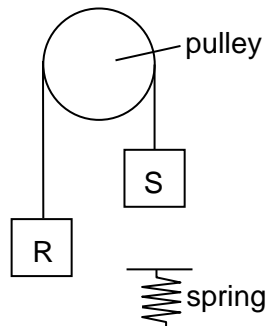
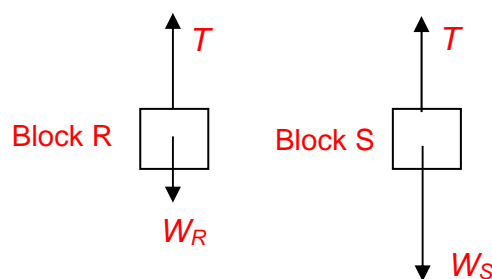

Fig. 6.1

- (i) Draw the labelled free-body diagrams of Blocks R and S at the instant when the system is released from rest. [2]



Legend:

 $T = \text{Tension}$ $W_R = \text{Weight of Block R}$ $W_S = \text{Weight of Block S}$

- T same magnitude on both [B1]
- $W_S > T > W_R$ [B1]

- (ii) Determine the magnitude of acceleration of Block S before striking the spring.

Method 1

Using Newton's second law

Block R, taking upwards as positive

$$T - W_R = m_R a \quad (\text{equation 1}) \quad [\text{M1}]$$

Block S, taking downwards as positive

$$W_S - T = m_S a \quad (\text{equation 2}) \quad [\text{M1}]$$

Solving

$$1.50(9.81) - (0.30)(9.81) = (1.50 + 0.30)a$$

$$a = 6.54 \text{ m s}^{-1} \quad [\text{A1}]$$

Method 2

Using Newton's second law

Consider Blocks R and S as one system, taking downwards as positive

$$W_S - W_R = (m_S + m_R)a \quad [\text{M1}]$$

$$1.50(9.81) - (0.30)(9.81) = (1.50 + 0.30)a \quad [\text{M1}]$$

$$a = 6.54 \text{ m s}^{-1} \quad [\text{A1}]$$

(iii) The acceleration of Block S decreases after it touches the spring. Block S comes to a stop after some time and the spring is observed to be compressed.

1. By considering the free body diagrams of both blocks at equilibrium, show that the maximum compression of the spring is 0.0235 m. [2]

After Block S comes to a stop, the forces acting on Blocks R and S are in equilibrium.

$$T' - W_R = 0 \quad (3)$$

$$W_S - T' - kx = 0 \quad (4) \quad [\text{M1 for both}]$$

Substitute (3) into (4),
 $1.50(9.81) - 0.30(9.81) - 500x = 0$ [M1]
 $x = 0.0235 \text{ m}$

2. Hence, explain how the maximum compression would change if a spring of smaller spring constant is used.

Since the weights of the two blocks remain the same [M1], when the spring constant decreases, the maximum compression increases [A1].

..... [2]

(iv) Sketch on Fig. 6.2 for Block S, the variation with the distance from the point of release of its

1. gravitational potential energy (label the graph G),
 2. elastic potential energy (label the graph E),
 3. kinetic energy (label the graph K).
- [3]

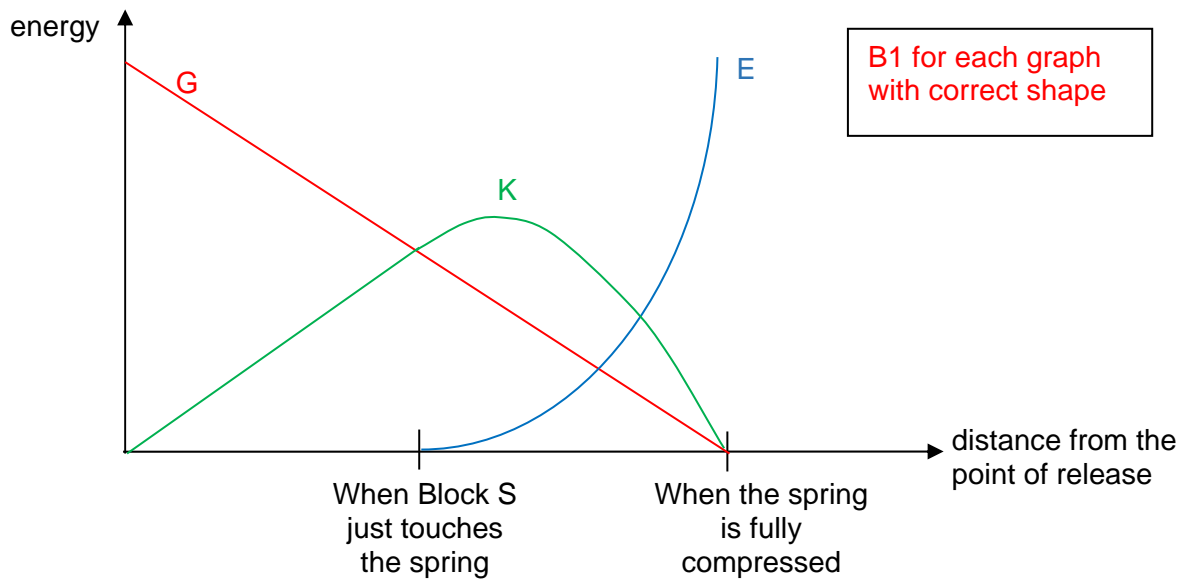

Fig. 6.2

- (c) Truck X of mass 22 000 kg and moving at a speed of 3.0 m s^{-1} , catches up and collides with Truck Y moving at 1.0 m s^{-1} moving in the same direction as shown in Fig. 6.3.

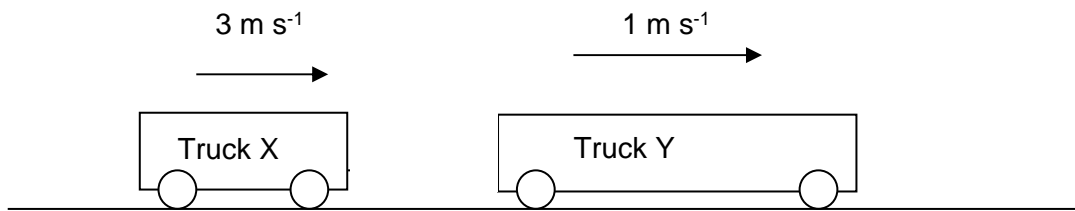

Fig. 6.3

Fig. 6.3 shows the variation of speeds v of the trucks with time t before, during and after the collision.

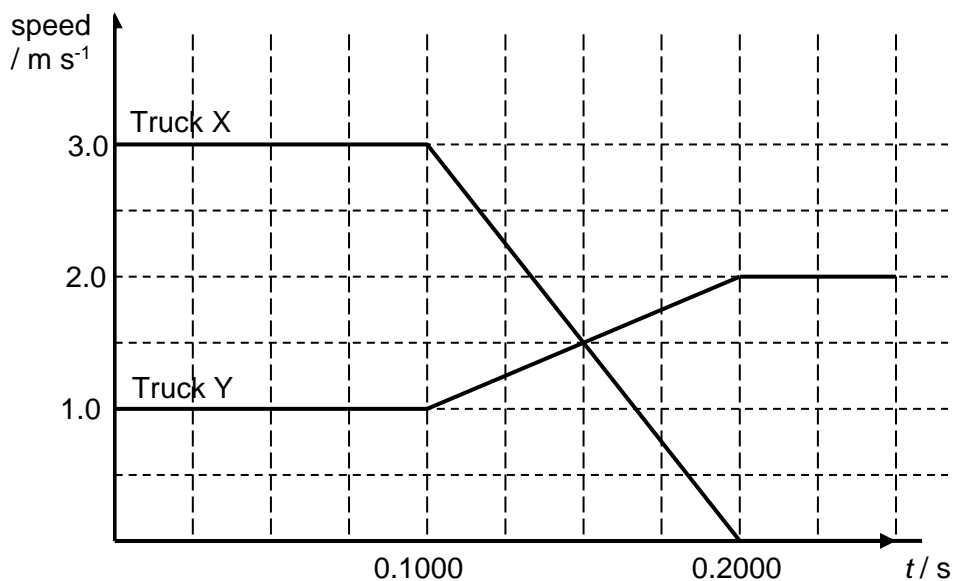

Fig. 6.3

- (i) Using Fig. 6.3, show that the mass of Truck Y is 66000 kg. [2]

Using Principle of Conservation of Linear Momentum,
Total momentum before collision = Total momentum after collision
or
 $m_X u_X + m_Y u_Y = m_X v_X + m_Y v_Y$ [M1]
 $22000(3.00) + m_Y(1.00) = 0 + m_Y(2.00)$ [M1]
 $m_Y = 66000 \text{ kg}$

- (ii) Show that the collision is elastic. [1]

Total kinetic energy before collision = $\frac{1}{2} \times 22000 \times 3^2 + \frac{1}{2} \times 66000 \times 1^2$
= $99000 + 33000$
= $132\,000 \text{ J}$

Total kinetic energy after collision = $0 + \frac{1}{2} \times 66000 \times 2^2 = 132\,000 \text{ J}$
[M1 for both total KE before and after]

OR

Relative speed of approach = $u_X - u_Y = 3 - 1 = 2 \text{ m s}^{-1}$
Relative speed of separation = $v_Y - v_X = 2 - 0 = 2 \text{ m s}^{-1}$
[M1 for both RSA and RSS]

- (iii) 1. Calculate the magnitude of the impulse exerted by Truck X on Truck Y.

| |
|---|
| Impulse = change in momentum = 66 000 (2 – 1) [M1] = 66 000 N s [A1] |
|---|

magnitude of the impulse = N s [2]

2. If the duration of collision is reduced, with initial and final speed of both trucks remain unchanged, state and explain how this affects your answer in 1.

| | |
|--|----------|
| The <u>change in momentum of Truck Y remains the same</u> since there is no change in the initial and final speeds of both trucks. By <u>Impulse-momentum theorem</u> , the impulse remains <u>unchanged</u> . [B1] | .. 1] |
|--|----------|

- 7 (a) State what is meant by *coherent sources*.

Coherent sources are sources that emit waves with constant phase difference. [B1]
This means that the waves have the same frequency/wavelength/speed (any 2). [B1]

.....
..... [2]

- (b) Fig. 7.1 below shows a progressive wave displayed on a cathode ray oscilloscope (c.r.o.). Sketch on Fig. 7.1 one cycle of a wave that has a phase difference of $\frac{\pi}{2}$ radians with the progressive wave.
with the progressive wave.

[2]

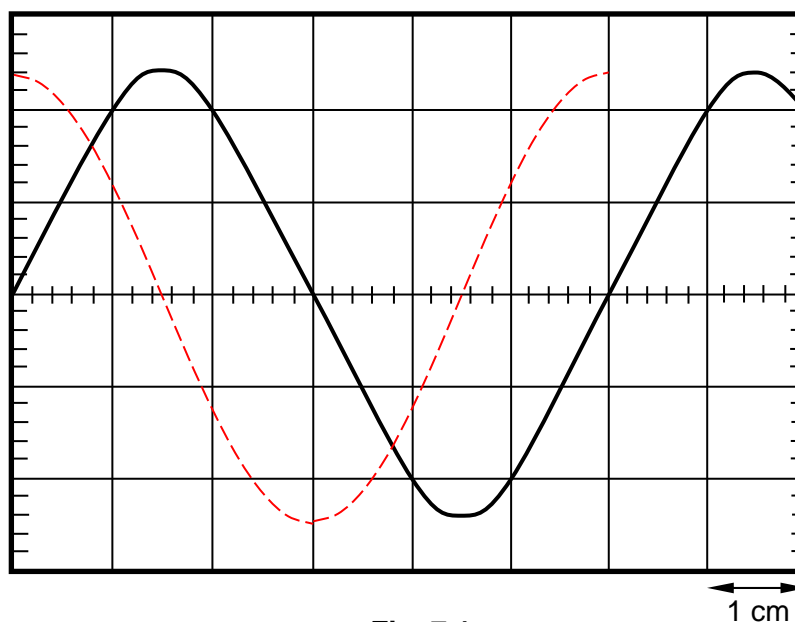

Fig. 7.1

Sinusoidal wave with same period: [M1]
Correct phase difference: [A1]

- (c) A stereo system in a large hall has two identical speakers, S_1 and S_2 , placed 1.2 m apart as shown in Fig. 7.2. The amplitude of the output of each speaker is proportional to the potential difference across its terminals, which is adjusted by means of a balance control.

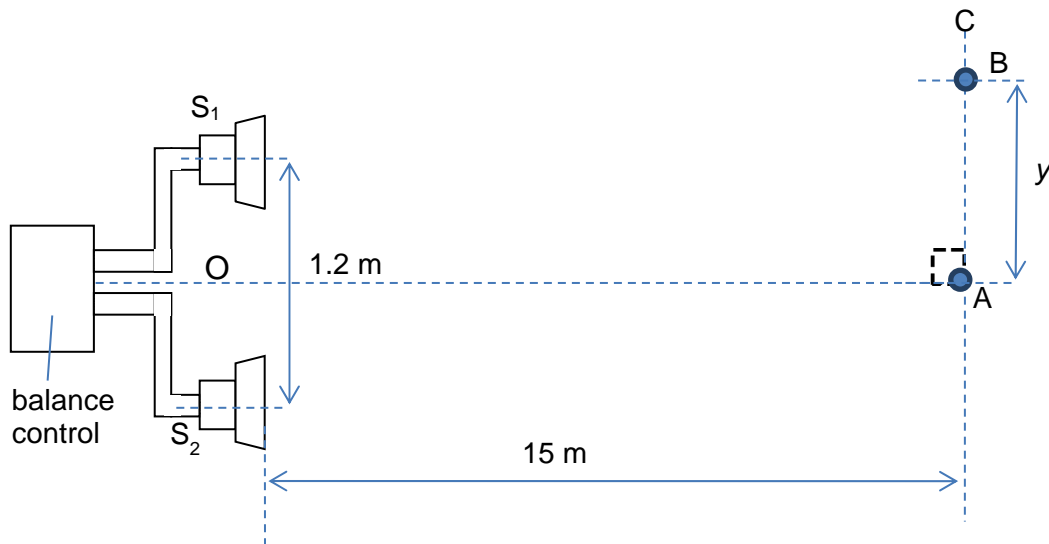

Fig. 7.2 (not to scale)

Initially, the speakers are emitting signals of frequency 1000 Hz which are in phase. The balance control is set such that the potential difference across the terminals of both speakers are the same.

Line AC is 15 m away from the speakers. An observer hears a loud sound of intensity I_{\max} at A. As he moves along the line AC, 15 m away from the speakers, he observes that the intensity of the sound first falls to zero at point B, a distance y from A. The speed of sound in air is 330 m s^{-1} .

- (i) Using Young's Double Slit formula, determine the distance between adjacent positions of loud sounds.

$$\lambda = \frac{v}{f} = \frac{330}{1000} = 0.33 \text{ m [B1]}$$

$$x = \frac{\lambda D}{a} = \frac{(0.33)(15)}{1.2} \text{ [M1 for formula, A1 for answer]}$$

$$= 4.2 \text{ m}$$

distance = m [3]

- (ii) Hence, show that the distance y is 2.1 m. [1]

y is the distance between the central maxima and the first order minima, hence it is half the distance between adjacent maxima. [B1]

Therefore, $y = 4.2 / 2 = 2.1 \text{ m}$.

- (iii) The balance control is now adjusted such that the amplitude of the signal from S_1 is reduced while the amplitude of the signal from S_2 is unchanged.

Suggest and explain any changes to the sound heard at B.

A sound is now heard at B. [B1]
 This is because there is now a difference between the amplitudes of the sounds at B, resulting in incomplete destructive interference. [B1]

.....
 [2]

- (iv) State the effect on the interference pattern along the line AC when the distance between the two speakers is decreased.

The distance between adjacent positions of loud and no sounds increases. [B1]

..... [1]

- (d) Fig. 7.3 shows a string stretched between two fixed points P and Q.

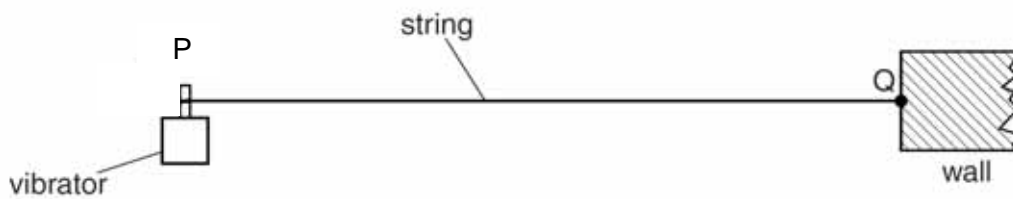

Fig. 7.3

A vibrator is attached at end P of the string. End Q is fixed to a wall. The stationary wave produced on PQ at one instant of time t is shown on Fig. 7.4. Each point on the string is at its maximum displacement.

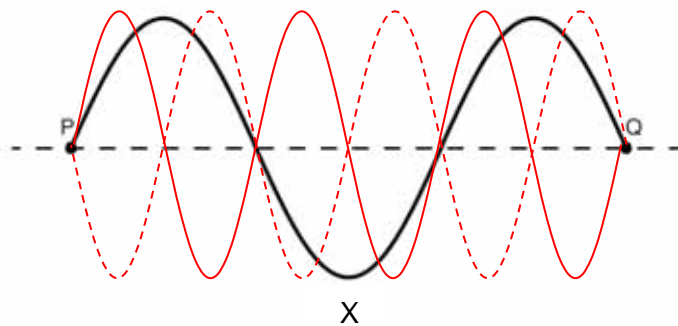

Fig. 7.4

- (i) Explain how this arrangement may produce a stationary wave on the string.

The wave from P travels along string and reflects at Q [B1]. Hence the 2 waves travel in opposite directions.

The incident and reflected waves, which have the same amplitude, speed and frequency/wavelength travelling in opposite directions, interfere / superpose to form a stationary wave. [B1]

- (ii) It takes 0.01 s for the point X on the string to reach the highest point of its oscillation.

Calculate the frequency of the vibrator.

$$f = \frac{1}{T}$$

$$= \frac{1}{2 \times 0.01}$$

$$= 50 \text{ Hz}$$

[B1 for formula. B1 for answer]

- (iii) The length of PQ is 1.2 m. Determine the wavelength of the stationary wave.

$$1.5\lambda = 1.2$$

$$\lambda = \frac{2}{3} \times 1.2 = 0.8 \text{ m}$$

[B1 for identifying wavelength as 2/3 of length of PQ, B1 for answer]

wavelength = m [2]

- (iv) Hence, show that the speed of the stationary wave is 40 m s⁻¹. [1]

$$v = f\lambda = (50)(0.8)$$

$$= 40 \text{ ms}^{-1}$$

[B1 for formula and substitution]

- (v) Draw on Fig. 7.4 the stationary wave when the frequency of the vibrator is doubled while keeping the speed of the wave constant. [2]

[B1]: Wavelength of 0.4 m (ie distance between adjacent nodes/antinodes is 0.2m)

[B1]: Must draw both the bolded and dotted lines to indicate that it is a stationary wave.

8 (a) A household electric lamp is rated as 240V, 40W. The filament lamp is made from tungsten wire of radius 5.0×10^{-6} m. The resistivity of tungsten at the normal operating temperature of the lamp is $7.9 \times 10^{-7} \Omega\text{m}$.

(i) For the lamp at its normal operating condition, show that the resistance of the filament is 1440 Ω .

| |
|--|
| $P = V^2 / R$ $40 = 240^2 / R \quad [M1]$ $R = 1440 \Omega \quad [A0]$ |
|--|

[1]

(ii) Calculate the length of the filament.

| |
|---|
| $R = \rho L / A \quad [C1]$ $1440 = (7.9 \times 10^{-7}) L / [\pi(5.0 \times 10^{-6})^2] \quad [M1]$ $L = 0.143 \text{ m} \quad [A1]$ |
|---|

length = m [3]

(iii) Comment on your answer in (ii).

| | |
|--|----------|
| The length of the filament is too long for the lamp. [B1] So, the filament must be coiled. [B1] | [2] |
|--|----------|

(b) An electric heater consists of three similar heating elements A, B, C, connected as shown in Fig. 8.1.

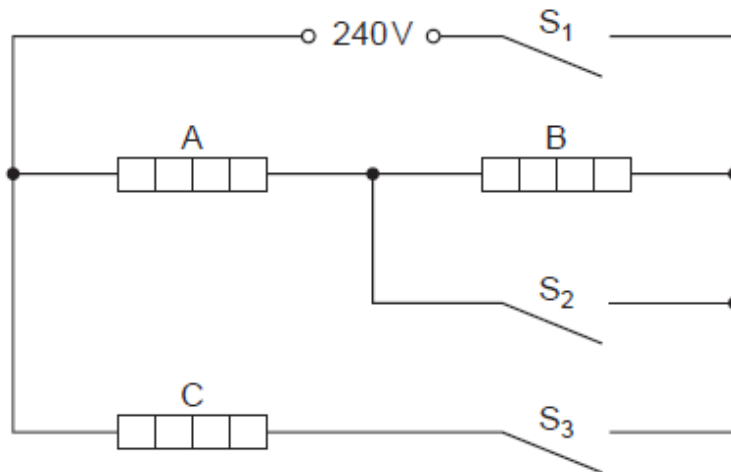

Fig. 8.1

Each heating element is rated as 1.5kW, 240V and may be assumed to have constant resistance.

The circuit is connected to a 240 V supply.

The switches S_1 , S_2 and S_3 may be either open or closed.

- (i) When S_1 , S_2 and S_3 are all closed, state the total power dissipation of the heater.

B is bypassed and current flows through A and C. P.d. across A and C is 240V. So A and C dissipates 1.5 kW each, and collectively 3.0 kW.

total power dissipation = kW [1]

- (ii) When S_1 is closed, S_2 is open, and S_3 is open, show that the total power dissipation of the heater is 0.75 kW. [2]

Current flows through A and B, but not C. P.d. across A and B is 120V each. Since $P=V^2/R$, power is proportional to V^2 (for constant R).

$$\frac{P_{120}}{P_{240}} = \frac{V_{120}^2}{V_{240}^2}$$

$$\Rightarrow P_{120} = P_{240} \frac{V_{120}^2}{V_{240}^2} = 1.5 \frac{120^2}{240^2} = 0.375 \text{ kW} \quad [\text{M1}]$$

$$\Rightarrow P_{total} = 0.375 + 0.375 \quad [\text{A1}]$$

$$= 0.750 \text{ kW (shown)}$$

- (iii) Hence, determine the total power dissipation of the heater when S_1 is closed, S_2 is open, and S_3 is closed.

Current flows through A, B and C. P.d. across A and B is 120V each, and as found in part (4) previously the power dissipated in A and B collectively is 0.75 kW.

P.d. across C is 240V, so power dissipated in C is 1.5kW.

Thus, all together, the total power dissipated in A, B and C = $0.75 + 1.5 = 2.25$ kW [A1]

total power dissipation = kW [1]

- (c) On Fig. 8.2, sketch the temperature characteristic of a thermistor.

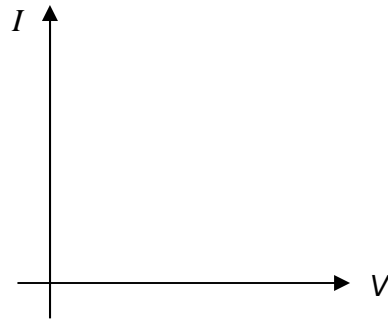
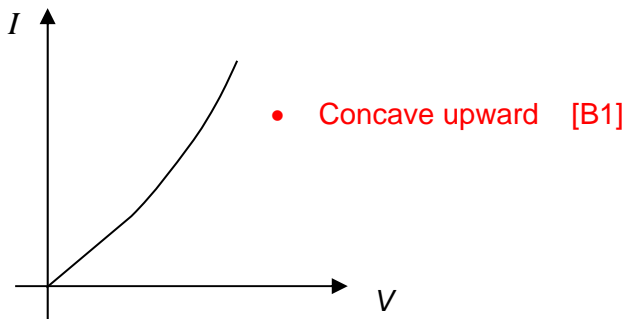

Fig. 8.2

[1]



- (d) A potential divider circuit is shown in Fig. 8.3.

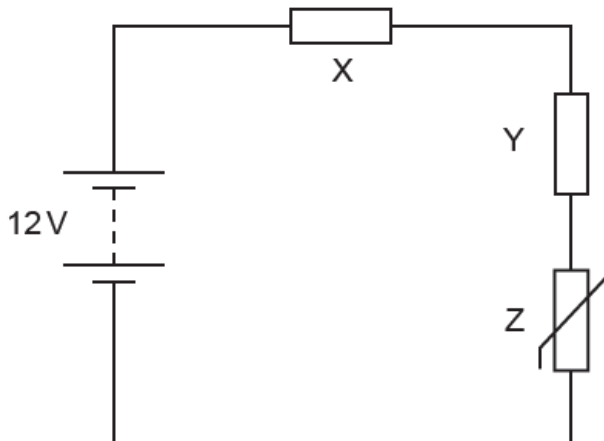

Fig. 8.3

The battery of electromotive force (e.m.f.) 12 V and negligible internal resistance is connected in series with resistors X and Y and thermistor Z. The resistance of Y is 15 k Ω and the resistance of Z at a particular temperature is 3.0 k Ω . The potential difference (p.d.) across Y is 8.0 V.

- (i) By reference to the circuit shown in Fig. 8.3, distinguish between the definitions of e.m.f. and p.d.

The electromotive force of a source is the electrical energy converted from other forms of energy per unit charge delivered round a complete circuit. [B1]

The potential difference between two points in a circuit is the amount of energy converted from electrical to other forms of energy per unit charge passing from one point to the other. [B1]

..... [2]

- (ii) Calculate the current in the circuit.

$$\begin{aligned}
 I &= V/R \\
 &= 8/(15 \times 10^3) \text{ [M1]} \\
 &= 0.53 \times 10^{-3} \text{ A [A1]}
 \end{aligned}$$

current = A [2]

- (iii) Calculate the resistance of X.

$$\begin{aligned}
 \text{p.d. across X} &= 12 - 8.0 - (3.0 \times 10^3)(0.53 \times 10^{-3}) = 2.4 \text{ V [M1]} \\
 R_X &= 2.4 / (0.53 \times 10^{-3}) \text{ [M1]} \\
 &= 4.52 \times 10^3 \Omega \text{ [A1]}
 \end{aligned}$$

OR

$$\begin{aligned}
 R_{\text{total}} &= 12 / (0.53 \times 10^{-3}) = 22.5 \times 10^3 \text{ [M1]} \\
 R_X &= (22.5 - 15.0 - 3.0) \times 10^3 \text{ [M1]} \\
 &= 4.52 \times 10^3 \Omega \text{ [A1]}
 \end{aligned}$$

resistance = Ω [3]

- (iv) The temperature of Z is decreased.
State and explain the effect of this on the potential difference across Z.

Resistance of Z increases hence current in circuit is smaller. [M1]
P.d. across X and Y decreases, hence p.d. across Z increases. [A1]

OR

By potential divider principle,
 R_Z increases so $R_Z / (R_X + R_Y + R_Z)$ is larger. [M1]
Therefore p.d. across Z increases. [A1]

..... [2]

END OF PAPER