

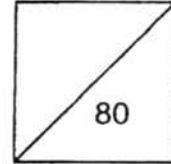

HENRY PARK PRIMARY SCHOOL
2017 SEMESTRAL EXAMINATION 2
SCIENCE
PRIMARY 3

Duration of Paper: 1 h 30 min



Name: _____ ()

Parent's Signature _____

Class: Primary 3 _____

Section A: Multiple-Choice Questions (20 X 2 = 40 marks)

For each question from 1 to 20, four options are given. One of them is the correct answer. Make your choice (1, 2, 3 or 4). Shade the correct oval (1, 2, 3 or 4) on the **Optical Answer Sheet**.

1. The diagram below shows the different stages of a young plant's life cycle.

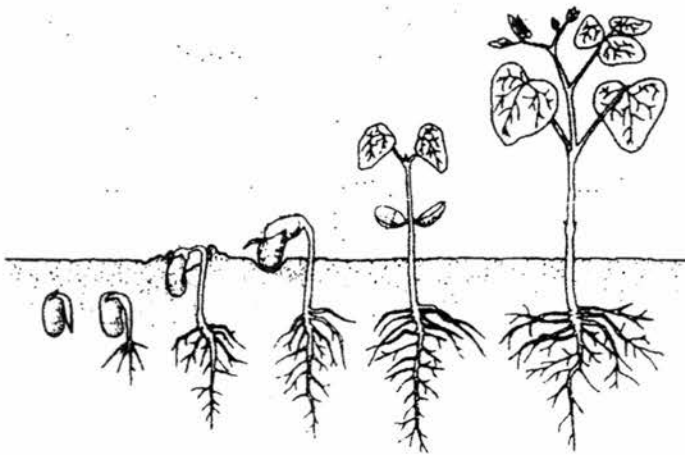

What do these stages in the plant life cycle show?

- (1) Living things can die.
- (2) Living things can grow.
- (3) Living things can respond.
- (4) Living things can move on their own.

()

2. Richard cleaned and changed the water in his fish tank every day. He fed his fish every day to ensure that they have enough food.

On the first day, the fish swam around in the water. However, by the sixth day, Richard found his fish swimming closer to the surface of the water even after they had eaten.

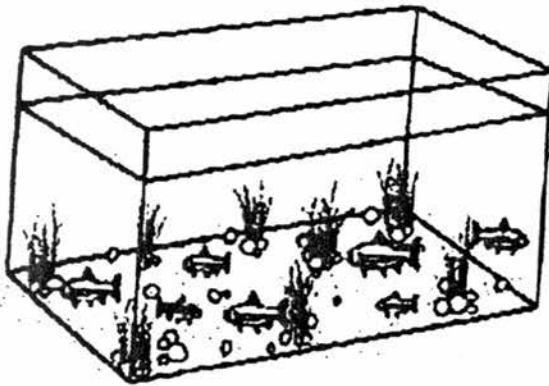

Day 1

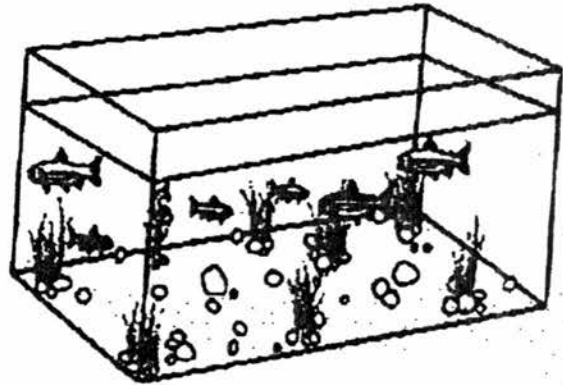

Day 6

Which one of the following statements is the most likely reason why Richard's fish swam closer to the surface of the water?

- (1) The fish needed sunlight.
- (2) The fish were looking for food.
- (3) The water nearer to the surface of the water has more air.
- (4) The water nearer to the surface of the water is warmer.

3. Mrs Yee saw an organism. She identified it as a reptile.

Which one of the following helped Mrs Yee to identify the organism as a reptile?

- (1) It lays eggs.
- (2) It lives in water.
- (3) It has dry scales.
- (4) It feeds on other animals.

4. Which of the following characteristic(s) is/are found in birds, but not in other animals?

- A: They lay eggs.
- B: They have wings.
- C: They have feathers on their bodies.

- (1) C only
- (2) A and B only
- (3) A and C only
- (4) B and C only

()

5. The diagrams below show two plants, A and B.

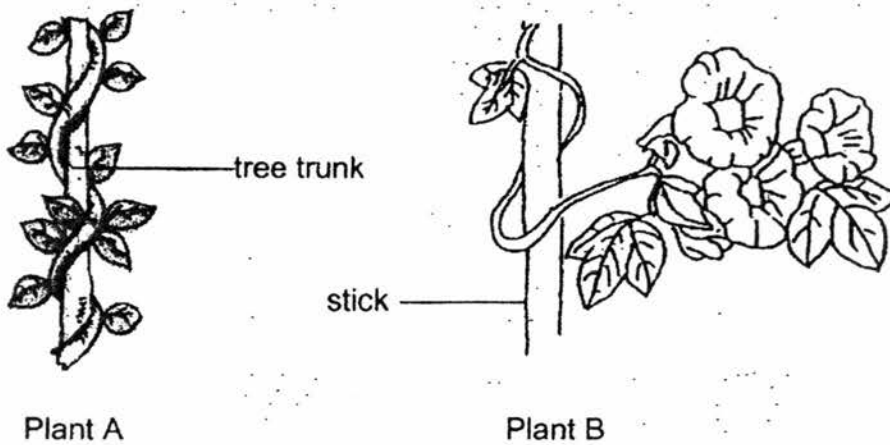

Which one of the statements about plants A and B is correct?

- (1) A has a weak stem but B does not have a weak stem.
- (2) A uses its leaves while B uses its flowers to climb up the support.
- (3) Both A and B cannot use their leaves to make their own food.
- (4) Both A and B use their stems to climb up the support to get sunlight.

()

6. Study the flowchart below.

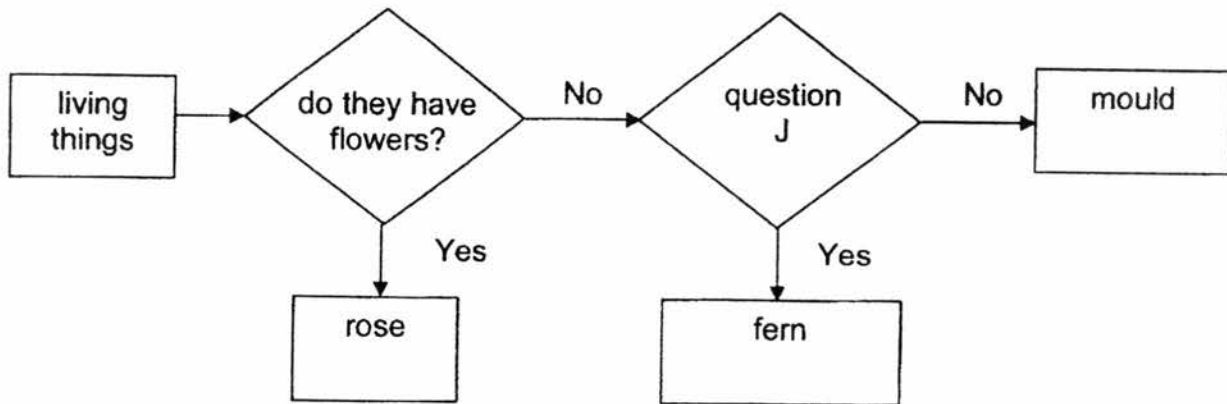

Which one of the following best represents question J?

- (1) Do they bear fruits?
- (2) Do they make food?
- (3) Do they have seeds?
- (4) Do they have spores?

()

7. The diagrams below show two organisms, A and B.

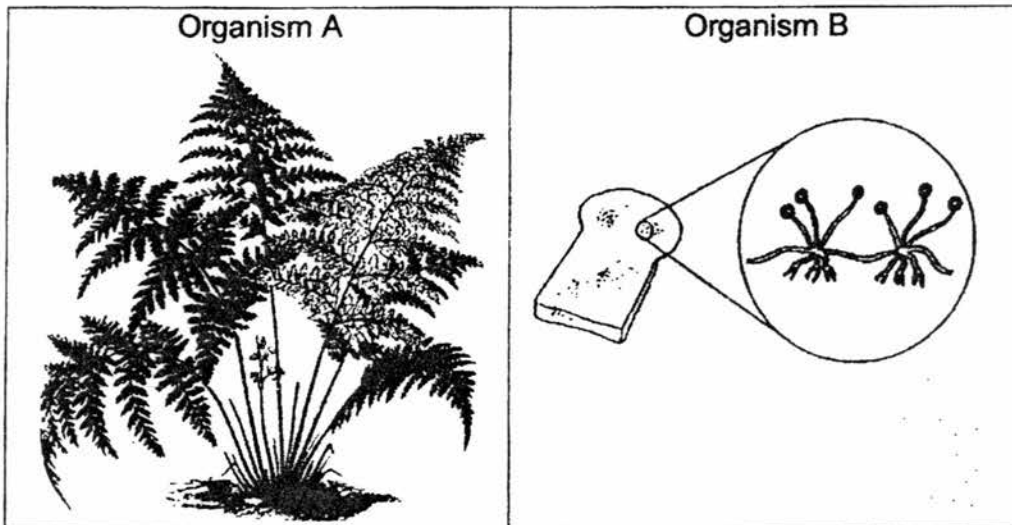

Some pupils made the following statements about organisms A and B.

- Pupil P: A and B are plants.
- Pupil Q: A and B feed on other living things.
- Pupil R: A and B reproduce from spores.

Which of the following pupil(s) gave the correct statement(s)?

- (1) Q only
- (2) R only
- (3) P and Q only
- (4) P and R only

()

8. Mrs Tan went to the supermarket and bought some groceries. She wanted to ensure that she could carry them home in a bag that has the following properties:

- it is waterproof
- it does not tear easily
- it can be easily folded

Which of the following materials should Mrs Tan's bag be made of?

- (1) Glass
- (2) Paper
- (3) Fabric
- (4) Plastic

()

9. Which of the following objects are made from materials that came from plants?

- A: rubber ball
B: paper bag
C: metal ruler

- (1) A and B only
- (2) A and C only
- (3) B and C only
- (4) A, B and C

()

10. Four objects made of different materials, W, X, Y and Z, are dropped into a container of water. All the objects are of the same size and shape.

The table below shows the properties of the four different materials.

A tick (✓) indicates that the material has the property.

	Ability to float	Waterproof	Flexible	Strong
W		✓	✓	✓
X	✓		✓	
Y	✓	✓		✓
Z	✓	✓		

Which material is the **most** suitable for making part G of the sail boat shown below?



- (1) W
- (2) X
- (3) Y
- (4) Z

()

11. The diagram below shows what happened to the leaf of a plant after a period of time.

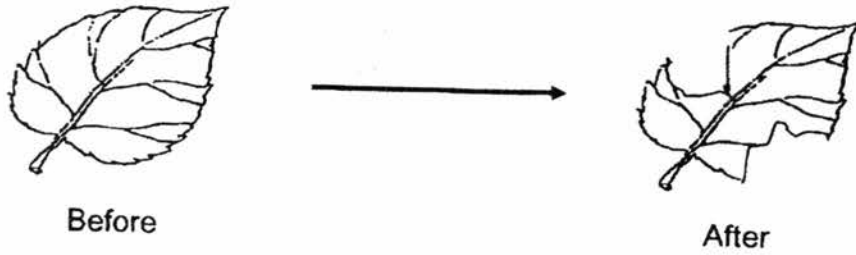

The change in the leaf was caused by a butterfly during a stage in its life cycle. Which stage is it?

- (1) egg
- (2) larva
- (3) pupa
- (4) adult

()

12. Alice was asked to draw and label the life cycle of an animal that has 3 stages. She drew 4 different life cycles as shown below. Which one of the life cycles is correct?

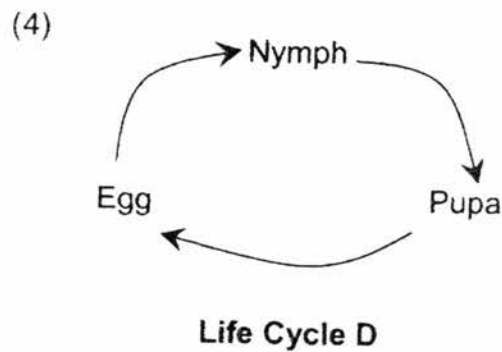
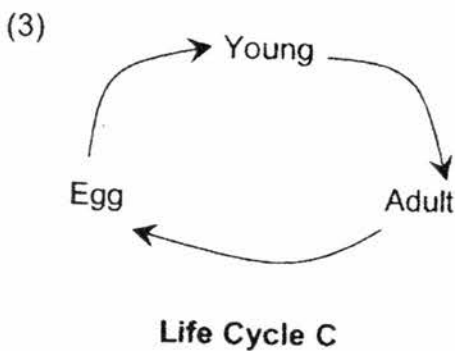
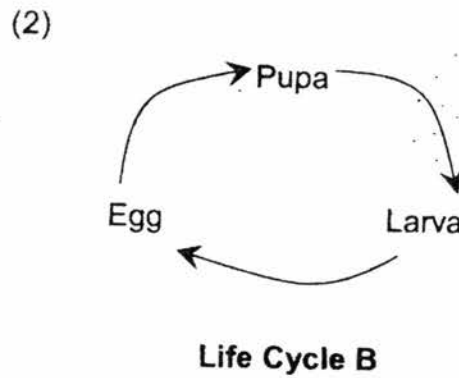
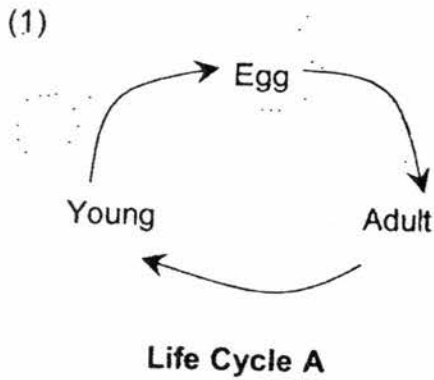

()

13. The leaves of plant M close when touched as shown in the diagrams below.

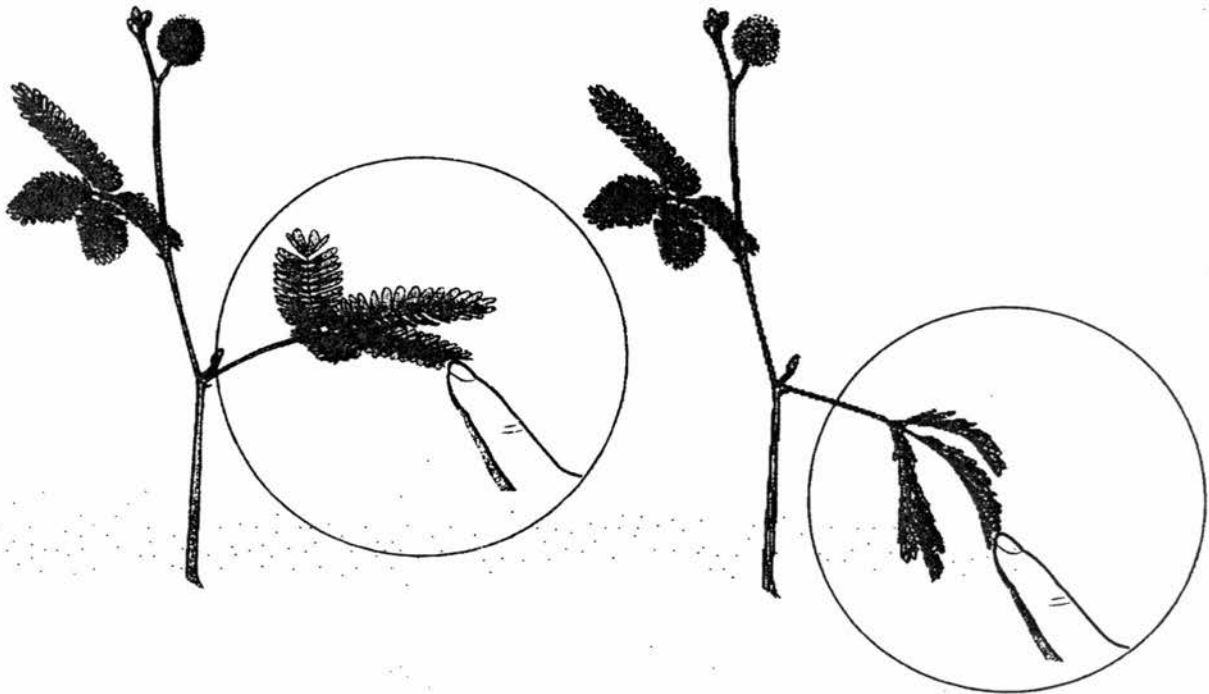



leaves of plant M are open

leaves of plant M are closed

This tells us that plant M is a living thing because it can _____.

- (1) die
- (2) grow
- (3) breathe
- (4) respond

14. Which of the following animals have young that looks like the adult?

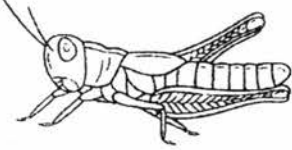
A	B	C
 Butterfly	 Chicken	 Grasshopper

- (1) A and B only
- (2) A and C only
- (3) B and C only
- (4) A, B and C

()

15. The diagram below shows a horse-shoe magnet. If the magnet is placed in a box of paper clips, which part of the magnet, A, B, C or D will attract the most number of paper clips?

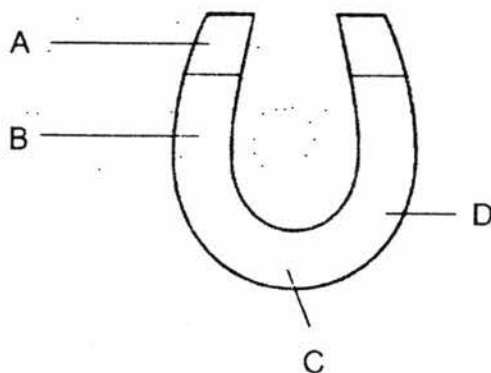

- (1) A
- (2) B
- (3) C
- (4) D

()

16. Study the classification chart below.

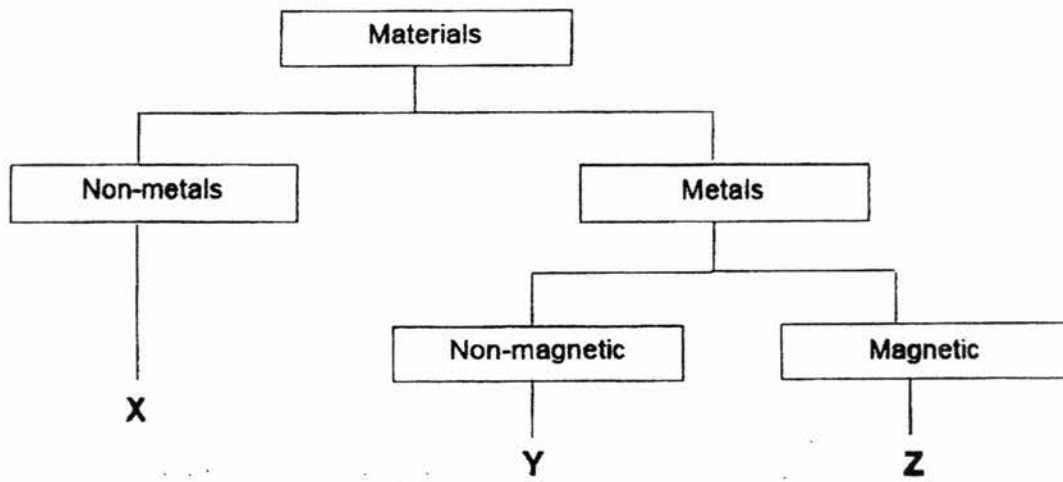

Based on the information given, which of the following is correct?

	X	Y	Z
(1)	copper	aluminium	iron
(2)	paper	copper	aluminium
(3)	rubber	gold	steel
(4)	cotton	steel	copper

17. Annie carried out an experiment on three objects with a magnet. She wanted to find out how the objects would respond when both the poles of the magnet are placed near them. Below are her results.

Object	Moved towards the magnet	Pushed away by the magnet
A	✓	✗
B	✗	✗
C	✓	✓

(✓ - Yes ✗ - No)

What could objects A, B and C be?

	A	B	C
(1)	magnet	ice cream stick	iron pin
(2)	iron pin	magnet	handkerchief
(3)	iron pin	ice cream stick	magnet
(4)	ice cream stick	iron pin	magnet

18. Ben placed two cubes, A and B, on a bar magnet as shown below.

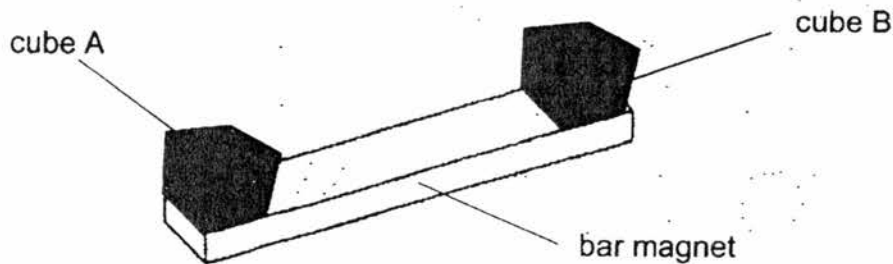

Ben then lifted up the bar magnet. He observed that cube A remained attached to the bar magnet but cube B immediately dropped off.

Ben wrote down some possible conclusions from his experiment.

Which of the following conclusion(s) is/are possible?

- A: Cube A is magnetic.
- B: Cube B repels the bar magnet.
- C: Cube B is made of a non-magnetic material.

- (1) A and B only
- (2) B and C only
- (3) A and C only
- (4) A, B and C

()

19. Betty brought a magnet near a metal paper clip. She observed that the paper clip was attracted to the magnet when it was still 5 cm away.

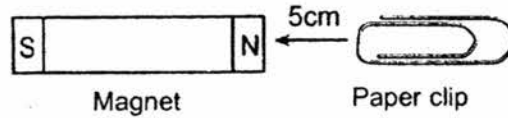

Based on her observation, which one of the following conclusions can Betty make?

- (1) Magnetic force can act at a distance.
- (2) The North pole of a magnet is the strongest.
- (3) The paper clip is made of a non-magnetic material.
- (4) Only the North pole of a magnet can attract a magnetic object at a distance. ()

20. The diagram below shows a doorstopper.

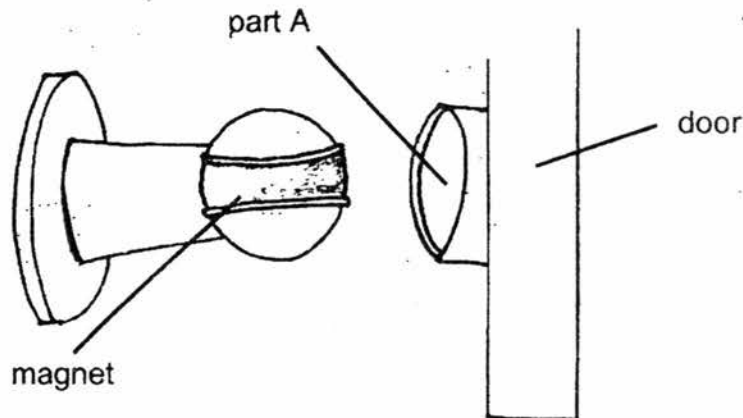

Part A is made of a magnetic material.

Which of the following statements below best explains how a door stopper keeps a door open?

- (1) The magnet repels part A.
- (2) The magnet attracts part A.
- (3) Part A is made from aluminium.
- (4) The magnet needs electricity to attract part A. ()

End of Booklet A

HENRY PARK PRIMARY SCHOOL
2017 SEMESTRAL EXAMINATION 2
SCIENCE
PRIMARY 3

Name: _____ ()

Class: Primary 3 _____

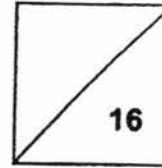

Section B: 8 Structured Questions (16 marks)
For questions 21 to 28, write your answers in the space given.

21. Four pupils answered the following question.

How are bacteria and ferns similar?

The diagrams below show their answers.

Put a tick (✓) in the box against the **correct** statement(s).

[2]

They are fungi.	They can reproduce.	They cannot die.	They need food.
<input type="checkbox"/>	<input type="checkbox"/>	<input type="checkbox"/>	<input type="checkbox"/>

22. The diagrams below show two animals, P and Q.

[2]



Animal P

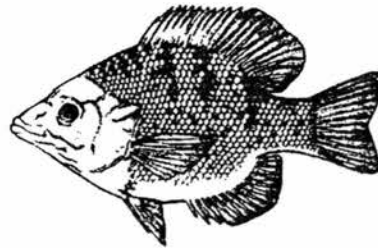

Animal Q

Complete the table below using the correct words.

	Animal P	Animal Q
Animal Group		Fish
Outer covering	Hair	

23. The diagram below shows the young and adult of some animals.

Draw lines to match the young with the correct adult.

[2]

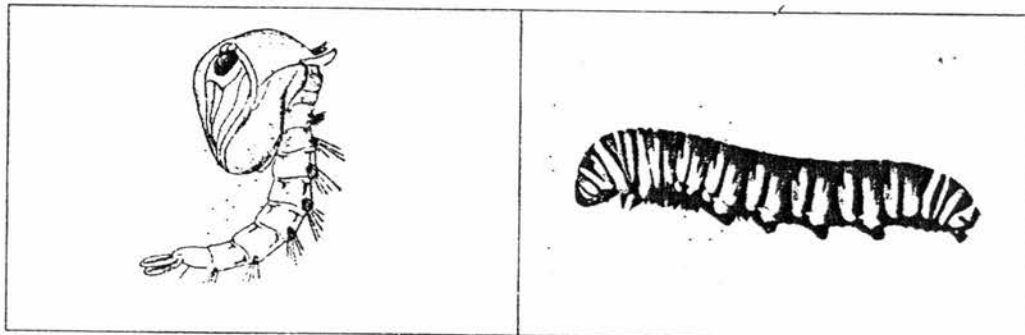
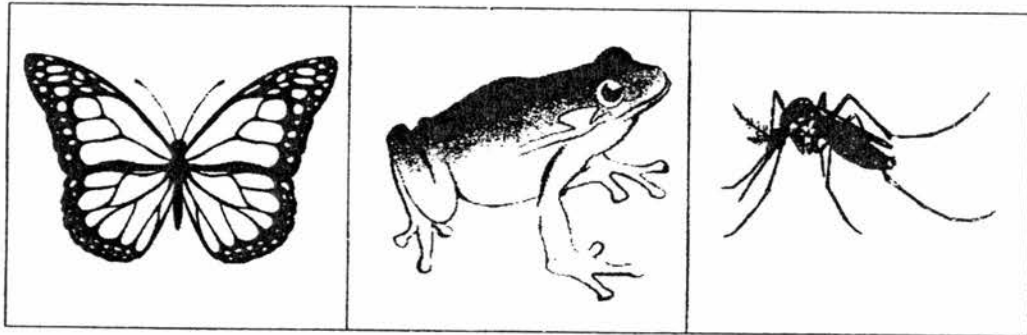

24. Write True (T) or False (F) in the correct boxes in the table below.

[2]

Statement	T / F
a) All bacteria are useful to humans.	
b) Yeast is a type of fungi.	
c) Some types of fungi can be eaten.	
d) Fungi reproduce by seeds.	

25. The picture below shows a pair of swimming goggles.

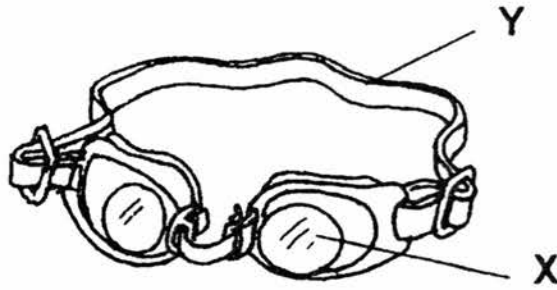

What materials are the parts X and Y made of?
Name a suitable material for each part.

[2]

Part X is made of _____.

Part Y is made of _____.

26. Study the diagram below.

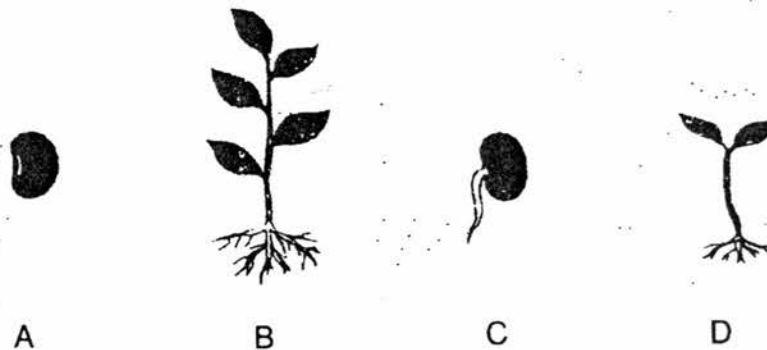

At which stages of the life cycle does the seedling make its own food?

[2]

27. The diagram below shows a compass.

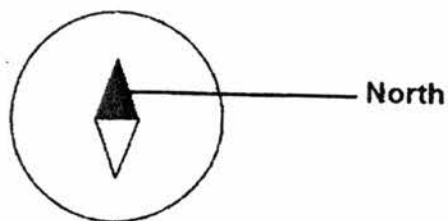

A similar compass is placed near a Set-up A as shown below.

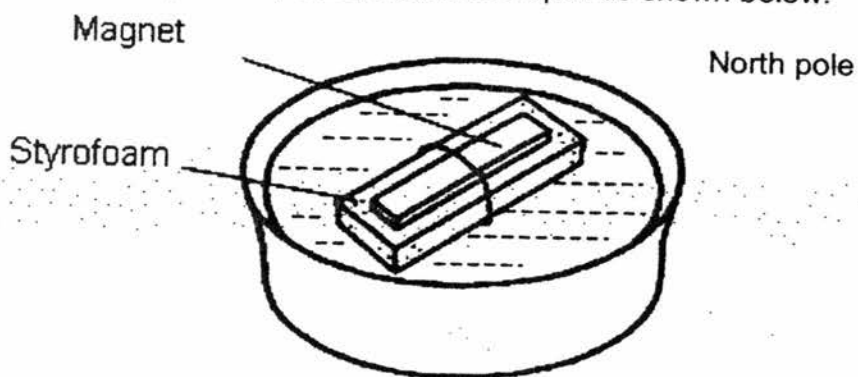

set-up A

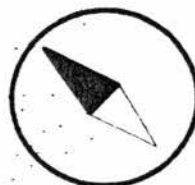

(a) Put a tick (✓) in the correct box, for the compass that shows the direction of the compass needle correctly. [1]



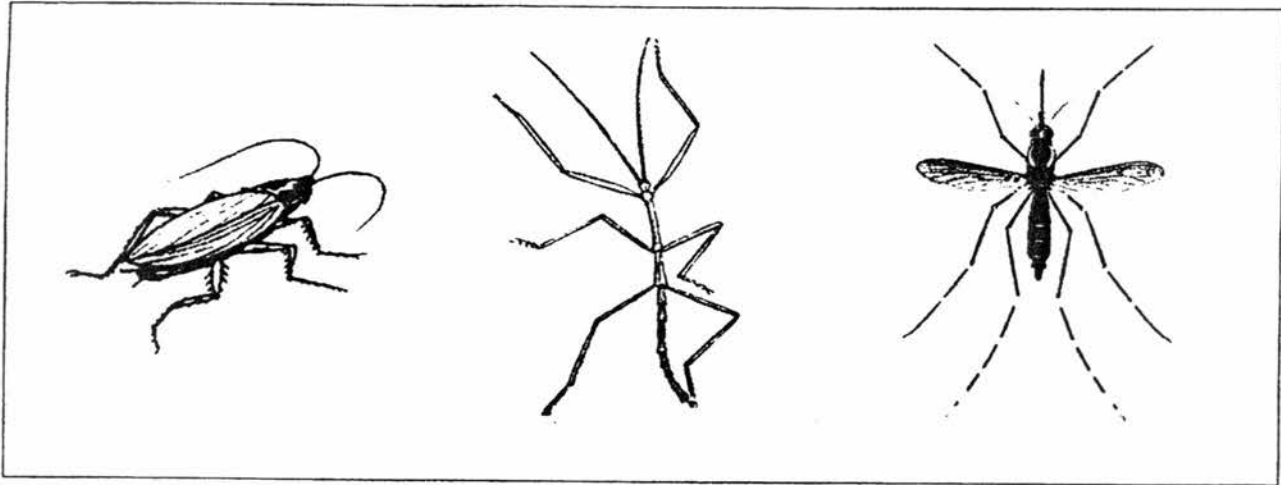

(b) Name a metal that is **not** magnetic. [1]

28. Study the 3 animals classified together below.



Which of the following animals can be placed in the group shown above? [2]

Put a tick (✓) in the correct boxes provided below.

			
<input type="checkbox"/>	<input type="checkbox"/>	<input type="checkbox"/>	<input type="checkbox"/>

HENRY PARK PRIMARY SCHOOL
2017 SEMESTRAL EXAMINATION 2
SCIENCE
PRIMARY 3

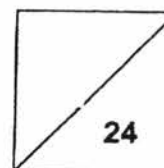

Name: _____ () Class: Primary 3 _____

Section C: 8 Open-Ended Questions (24 marks)

For each question from 29 to 36, write your answers in the spaces given.

29. Ferlicia found **animals M** and **N** in the forest. She did not know which animal group they belonged to. Both animals were at their adult stage.

After observing the animals for a few days, she recorded her observations in the table below. A tick (✓) means that the animal has the characteristics.

Characteristics	Animal	
	M	N
Does it have three body parts?		✓
Does it have moist skin?	✓	
Does it lay its eggs in water?	✓	
Does it have 3 pairs of legs?		✓

- a) Using the information given, which animal group does animal M most likely belong to? Explain your answer.

[1]

- b) Name **another** characteristic of animal M.

[1]

- c) Using the information given, explain why animal N **cannot** be a reptile.

[1]

30. Peter observed four different plants and recorded the data in the table below. A tick (✓) means the characteristic was observed.

Plant	Characteristics observed		
	Lives on land	Lives in water	Has spores
W	✓		
X		✓	✓
Y		✓	
Z	✓		✓

The chart below shows how some plants are classified into groups A, B, C and D.

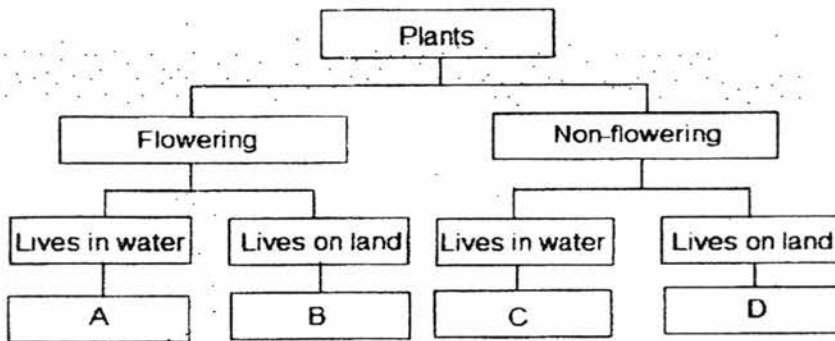

- (a) Which plant, W, X, Y or Z, can be placed in group B?
Explain your answer using the information given.

[2]



plant M

Peter observed plant M, shown above.

- (b) Which group, A, B, C or D, would Peter classify plant M under?

[1]

31. Josh hung strips of materials, A and B, as shown in the set-up below. Both strips were of the same size and thickness.



Two boxes of the same mass were hung from the strips. The diagram below shows what happened after the boxes were hung.

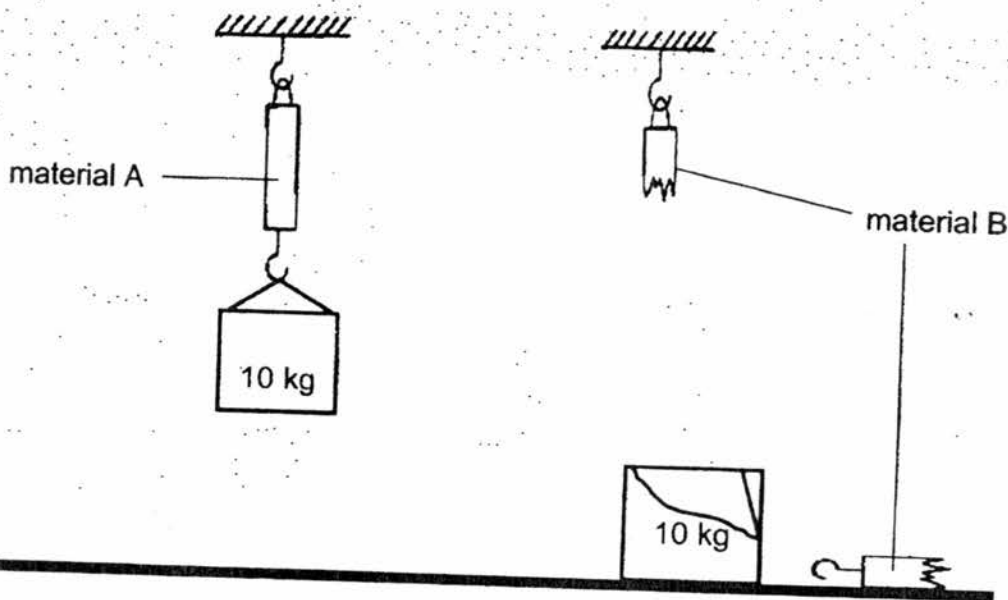

- a) Based on the experiment, what can Josh **conclude** about the strength of material B? Give a reason for your answer.

[2]

Question 31 continues on the next page

Question 31 continues on this page

Josh was taking a walk in a park. He noticed a hole near the footpath and wanted to cover it so that no one would fall into it.



- b) Which material, A or B, would be **more** suitable to cover the hole so that people can walk on it? [1]

32. Mark wanted to make raincoats for his children.

He carried a few tests on materials, A, B and C and recorded their characteristics in the table below.

Materials	Property		
	Waterproof	Strong	Flexible
A		✓	✓
B	✓	✓	
C	✓		✓

- a) Which material is the **most** suitable for making raincoats? [1]

- b) Based on the information given, explain why the material identified in part (a) is **most** suitable for making raincoats. [1]

Question 32 continues on the next page

Question 32 continues on this page

Muthu wanted to make a baby hammock.

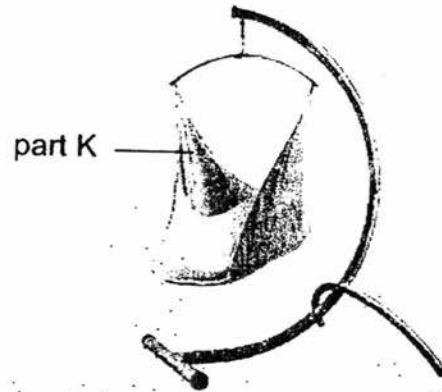

baby hammock

c) Based on the information given, which material (A, B or C) will be **most** suitable for making a part K of the baby hammock?

i) Material : _____

[1]

ii) Explain your answer in (i).

[1]

33. Some pupils observed the life cycle of insect X.
The table below shows what they observed at each stage of growth in the life cycle.

Date	Development at each stage	Amount of food taken
13 July	Eggs were laid in water.	0 g
17 July	?	50 g
26 July	Pupae were seen.	0 g
1 August	Pupae became adult insects.	47 g

Based on the information given, answer the following questions.

- a) How many stages are there in the life cycle of insect X? [1]

- b) What has happened to insect X on 17th July? [1]

- c) On 26th July, insect X did not take in any food.
Explain why. [1]

34. Ali baked a cake. He left the cake on the table to cool down. Then, he cut the cake into two parts and put each part on plates, A and B. The table shows what he did to both parts of the cake.

Plate A	The cake was wrapped in a plastic film.
Plate B	The cake was moistened with water, then wrapped with a plastic film.

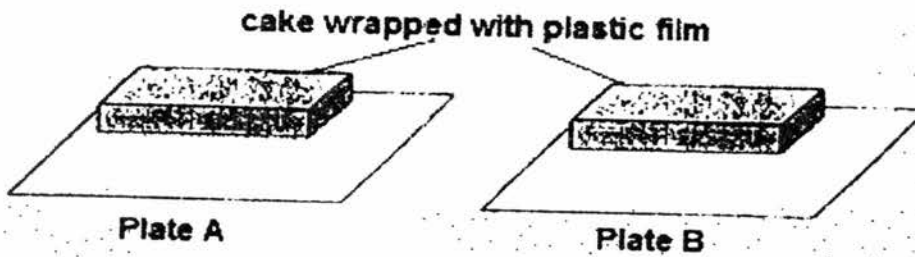

- a) On which plate would mould first appear on the cake?
Give a reason for your answer.

[1]

Andy had a medical condition in which fungus grew on his foot, as shown below.

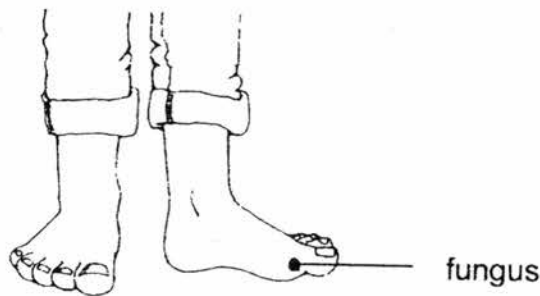

The doctor advised Andy to wear slippers to school instead of shoes and socks to **reduce** the fungus growing on his foot.

- b) Based on the experiment above, explain how wearing shoes and socks will lead to **more** fungus growing on Andy's foot.

[1]

35. David carried out an experiment using the set-up below.

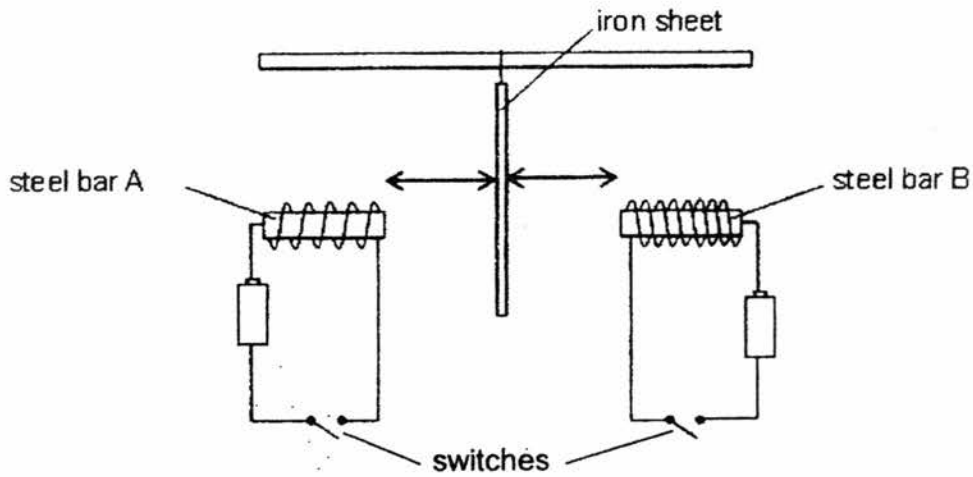

An iron sheet was hung freely at an equal distance from steel bars, A and B that were connected in two different circuits with identical batteries.

- a) Based on the set-up above, what do you think steel bars A and B would become if David closes the switches? [1]

David closed both the switches. The result is shown in the diagram below.

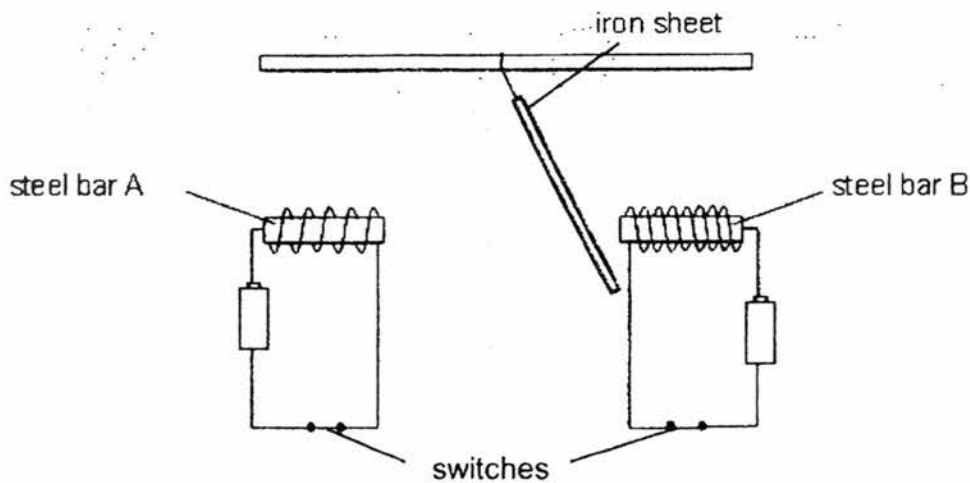

- b) Explain why the iron sheet moved towards steel bar B. [2]

36. Ellie observed the set-up shown below.

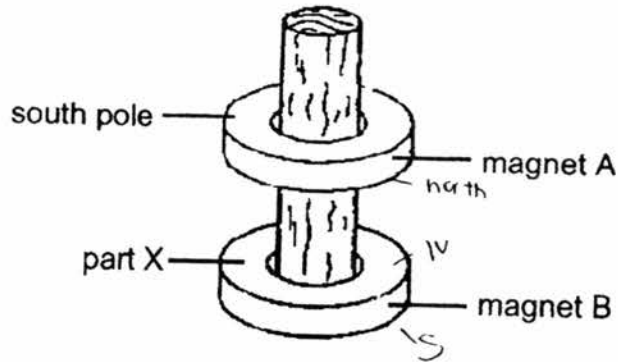

a) Explain why magnet A was able to remain above magnet B without touching it.

[1]

b) Name the pole for part X. _____

[1]

Ellie did something to magnet A and the result is shown in the diagram below.

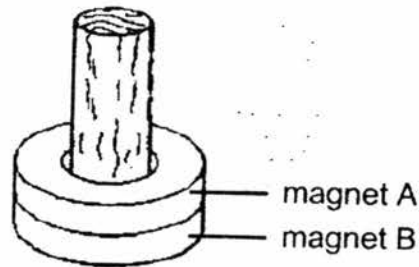

c) What could Ellie have done to magnet A?

[1]

End of Paper

ANSWER KEY



YEAR : 2017
LEVEL : PRIMARY 3
SCHOOL : HENRY PARK PRIMARY SCHOOL
SUBJECT : SCIENCE
TERM : SA2

SECTION A

Q1	Q2	Q3	Q4	Q5	Q6	Q7	Q8	Q9	Q10
2	3	3	1	4	2	2	4	1	1
Q11	Q12	Q13	Q14	Q15	Q16	Q17	Q18	Q19	Q20
2	3	4	3	1	3	3	3	4	2

(35)	<p>(a) The (steel) rods have become electromagnets/temporary magnets.</p> <p>(b) Steel bar B is a stronger (electromagnet/ magnet) as it has more iron coils around it.</p>
(36)	<p>Concept: Like Poles of magnets repel</p> <p>(a) Magnet A was repelling Magnet B as their like poles faced each other</p> <p>(b) North</p> <p>(c) She flipped the magnet (to the other side) / turn it the other side.</p>

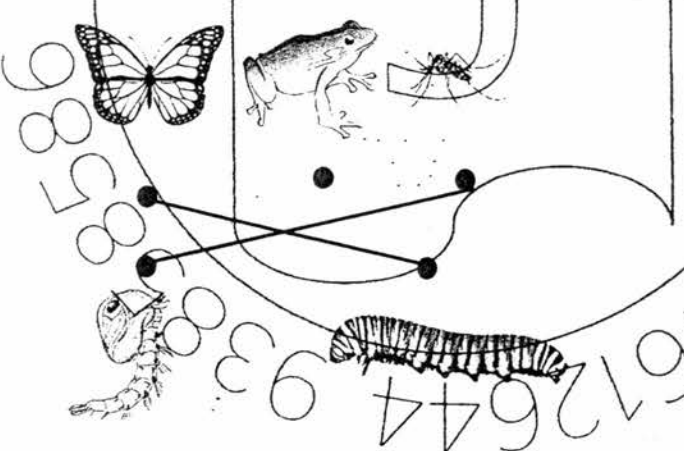
Ans Key – Section B

(21)	
(22)	<p>Animal P: Mammal (s) Animal Q: Scales</p>
(23)	
(24)	<p>a) F b) T c) T d) F</p>
(25)	<p>Part X : plastic Part Y : Rubber</p>
(26)	<p>B and D / seedling and adult</p>
(27)	<p>(a)</p> 

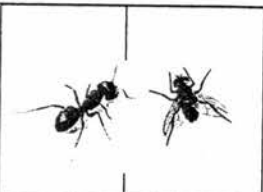
	(b) Aluminium / Copper / Gold / Silver / Zinc / Brass	
(28)		
	✓	✓

Ans Key: Section C

(29)	(a) Amphibian. It has moist skin. [1]
	(b) Lives on both on land and in water.
	(c) It has 3 body parts and 3 pairs of legs while reptiles do not have. [1]
(30)	(a) W. As it does not reproduce by spores and lives on land. [1]
	(b) A. [1]
(31)	(a) Material B is weaker than material A and Material B broke first after the 10kg box was hung from it.
	(b) A

(32)	(a) i) Material C
	(b) Raincoats must be waterproof and flexible
	(c) i) A (ii) A baby hammock must be strong and flexible to rock the baby and with stand its weight hence material A should be used to make a baby hammock.
(33)	Concept: Life Cycle Stages of growth
	(a) 4 stages
	(b) Eggs had hatched into larvae
	(c) It is at the pupae stage where the pupae is developing into an adult insect.

(34)	Concept: conditions for Fungi growth
	(a) Plate B as the cake had moisture.
	Cause and Effect
	(b) Wearing socks and shoes would cause the feet to perspire /sweat hence more fungus grow on feet that are wrapped up.