



NAN HUA PRIMARY SCHOOL
SEMESTRAL ASSESSMENT 1 – 2019
PRIMARY 3

SCIENCE

BOOKLET A

24 Multiple Choice Questions (48 marks)

Total Time for Booklets A and B : 1 hour 30 minutes

INSTRUCTIONS TO CANDIDATES

1. Write your name and index number in the space provided.
2. Do not turn over the page until you are told to do so.
3. Follow all instructions carefully.
4. Answer all questions.
5. Shade your answers in the Optical Answer Sheet (OAS) provided.

Marks Obtained

Booklet A		/48
Booklet B		/32
Total		/80

Name: _____ () Class: P 3 _____

Date : 15 May 2019

Parent's signature: _____

Section A: (24 x 2 marks = 48 marks)

For each question from 1 to 24, four options are given. One of them is the correct answer. Make your choice (1, 2, 3 or 4) and shade the correct oval on the Optical Answer Sheet.

1. Adam bought a hamster and placed it in a plastic container as shown in the diagram below. He ensured that the hamster had food every day.

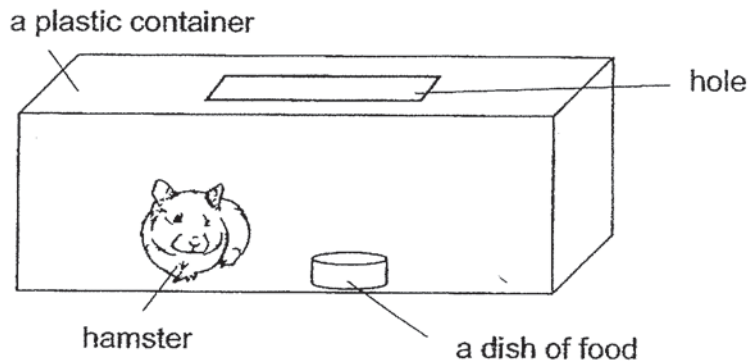

What else must Adam provide so that the hamster is able to survive?

- (1) air
 - (2) food
 - (3) water
 - (4) sunlight
2. Study the following statements:
- A A bird flies away upon seeing a cat coming near.
 - B A deer tries to escape when it is chased by a tiger.
 - C A dog barks fiercely when a stranger enters the house.

Which characteristic of living things does the above actions show?

- (1) Living things can grow.
- (2) Living things can reproduce.
- (3) Living things can respond to changes.
- (4) Living things need air, food and water to live.

3. Study the diagram below.

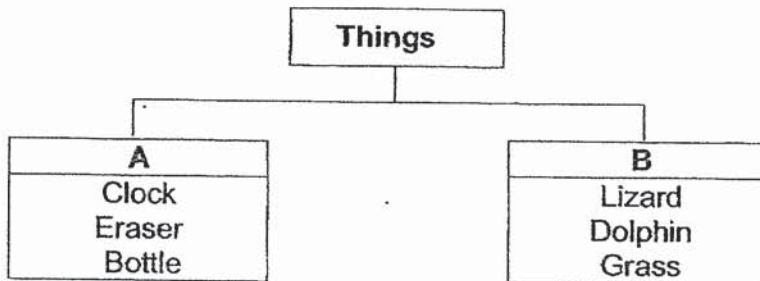

Which of the following pair of headings correctly represents A and B?

	A	B
(1)	Living things	Non-living things
(2)	Non-living things	Living things
(3)	Things that can grow	Things that cannot grow
(4)	Things that can move	Things that cannot move

4. The table below shows the characteristics of four living things, A, B, C and D.

Characteristic	A	B	C	D
Does it have legs?	No	Yes	Yes	Yes
Does it have scales?	Yes	No	No	No
Does it have hair?	No	No	No	Yes
Does it have feathers?	No	Yes	No	No

Which of the following correctly shows what A, B, C and D could be?

	A	B	C	D
(1)	Bird	Fish	Mammal	Amphibian
(2)	Mammal	Fish	Amphibian	Bird
(3)	Amphibian	Mammal	Bird	Fish
(4)	Fish	Bird	Amphibian	Mammal

5. Three students made the following statements about what they had learnt in their Science class.

- Alif : Insects have 3 pairs of legs.
- Betty : Amphibians live on land only.
- Carol : Fish, reptiles and amphibians have scales.
- Darren: Mammals produce milk to feed their young.

Whose statements are correct?

- (1) Alif and Betty only
- (2) Alif and Darren only
- (3) Carol and Darren only
- (4) Alif, Carol and Darren only

6. An orange was left on the kitchen table. After a week, a green patch was seen on the orange as shown in the diagram below.

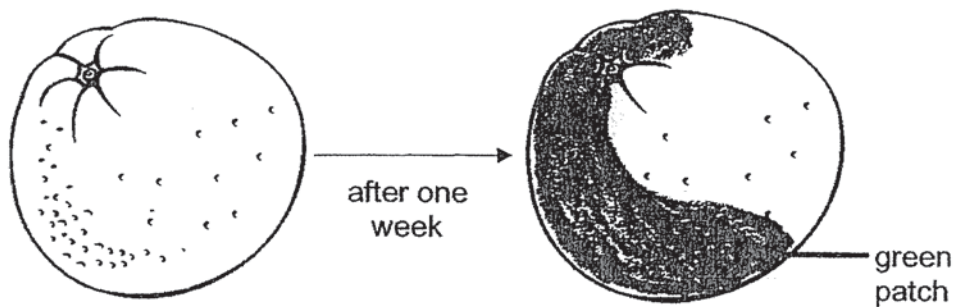

Which of the following statements about the green patch is correct?

- (1) It is a non-living thing.
- (2) It reproduces by seeds.
- (3) It reproduces by spores.
- (4) It can make its own food.

7. The flowchart below shows the characteristics of living things D, E and F.

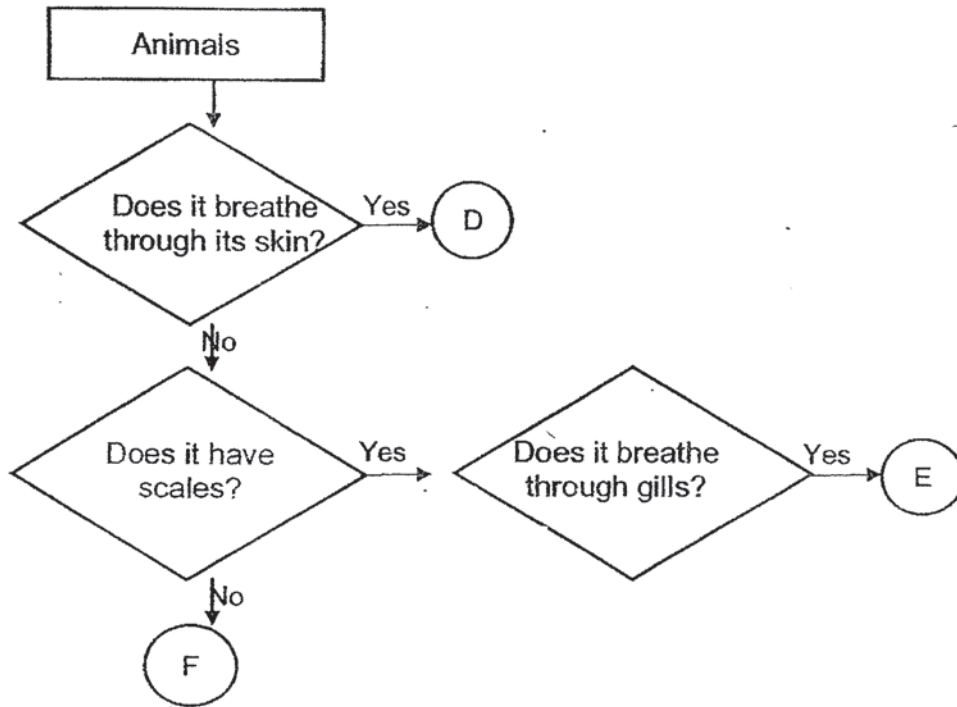

Which of the following sets of living things best represents D, E and F?

	D	E	F
(1)	Insects	Fish	Reptiles
(2)	Insects	Reptiles	Birds
(3)	Amphibians	Reptiles	Mammals
(4)	Amphibians	Fish	Birds

8. Material G is used to make the shelves of a trophy cabinet and a table as shown in the diagrams below.

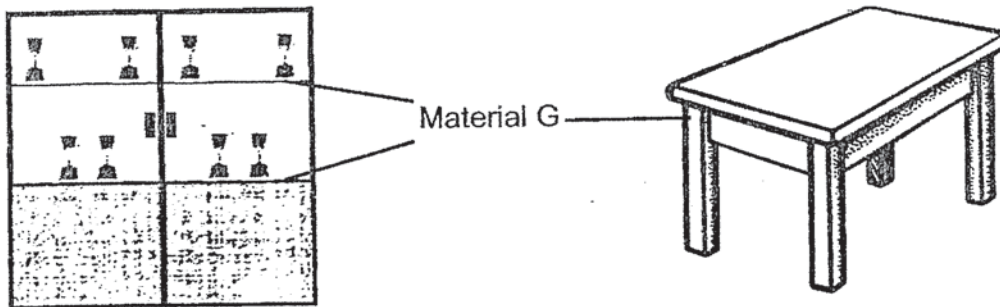

Which property of material G allows the cabinet and table to withstand the mass of heavy objects?

- (1) strength
- (2) flexibility
- (3) waterproof
- (4) ability to float

9. A waterproof umbrella is used on rainy days as shown in the diagram below.



Which of the following objects has this similar property as the umbrella?

(1)

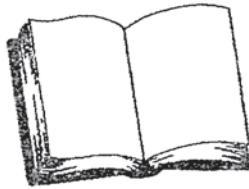

book

(2)



plastic bag

(3)



T-shirt

(4)



wooden chair

10. Sandy noted down her observations on object A.



- It is flexible.
- It absorbs water.
- It will sink in water.

Which of the following could object A be?

(1)



rubber frog

(2)



plastic bowl

(3)



metal ruler

(4)

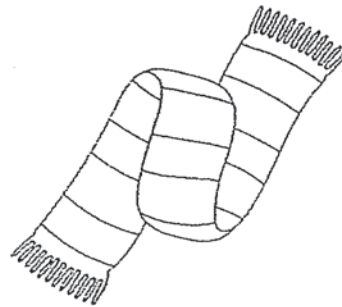

cotton scarf

11. Study the grouping below.

Group X	Group Y
aluminium foil	metal chopsticks
bath towel	glass bottle

The objects are grouped according to their _____.

- (1) strength
- (2) flexibility
- (3) transparency
- (4) ability to float or sink in water

12. The picture below shows a coat.



Which of the following materials can be used to make a coat?

- (1) wood
- (2) glass
- (3) fabric
- (4) metal

13. Study the flowchart below.

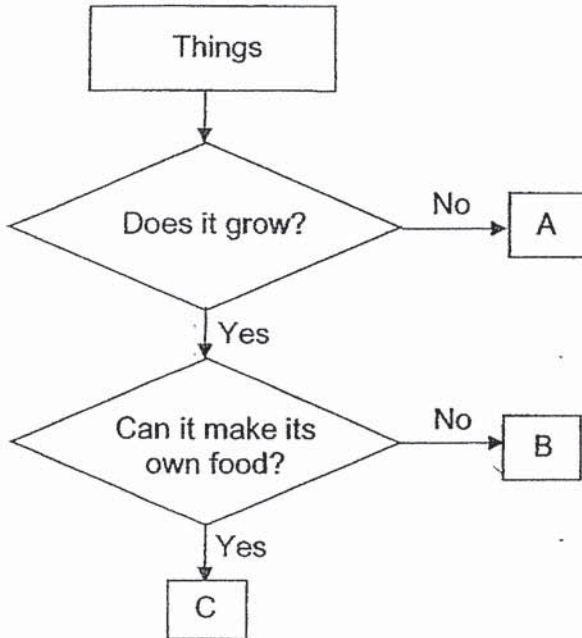

Which of the following things correctly represent A, B and C?

	A	B	C
(1)	Bicycle	Chicken	Moss
(2)	Bicycle	Moss	Chicken
(3)	Moss	Bicycle	Chicken
(4)	Chicken	Moss	Bicycle

14. Sunny went to the zoo. He classified some of the things that he saw in the diagram below.

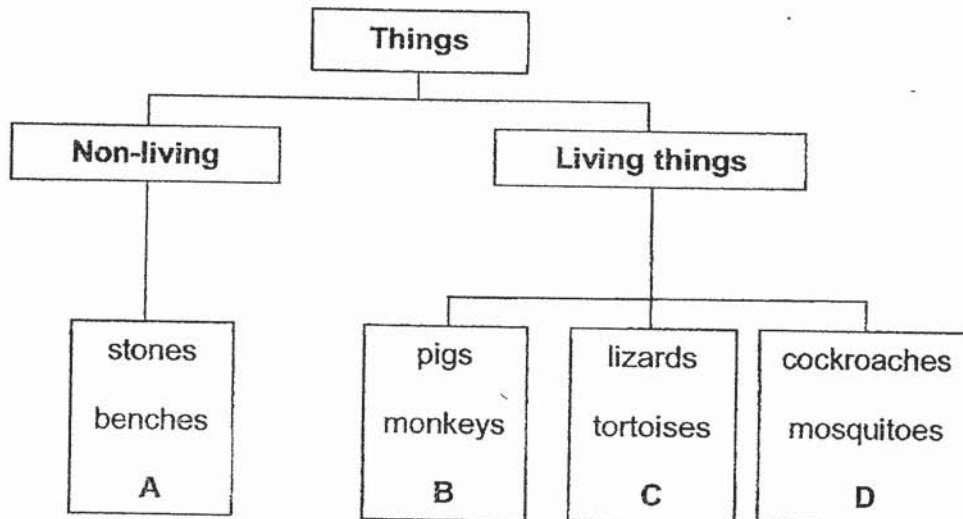

He also observed the following things and added them into the diagram above as A, B, C and D.



butterfly

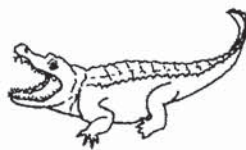

crocodile

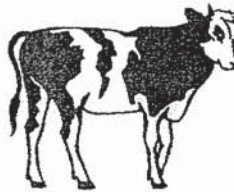

cow



leather bag

Which of the following correctly represent A, B, C and D?

	A	B	C	D
(1)	leather bag	crocodile	butterfly	cow
(2)	leather bag	cow	crocodile	butterfly
(3)	crocodile	cow	leather bag	butterfly
(4)	crocodile	leather bag	cow	butterfly

15. Study the flowchart below.

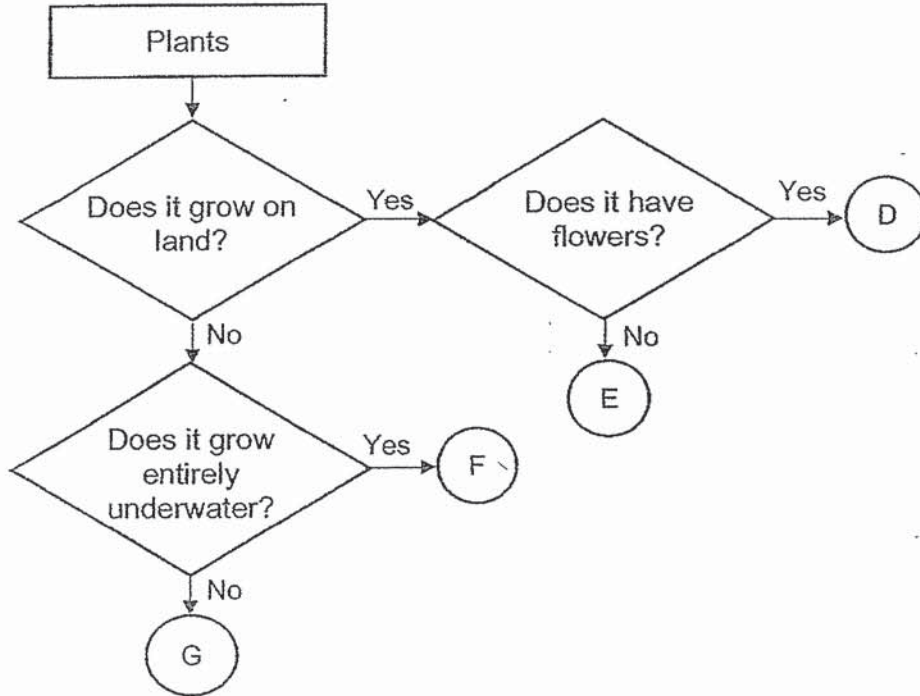







The water lily is a water plant. Its roots are in water while its leaves and flowers float on the water surface.

Based on the diagram above, which of the following letters best represents the water lily plant?

- (1) D
- (2) E
- (3) F
- (4) G

16. The animals below are classified into three groups, P, Q and R.

P	Q	R
 Angelfish	 Butterfly	 Dog
 Whale	 Pigeon	 Tiger

Which of the following are suitable headings for P, Q and R?

	P	Q	R
(1)	Have scales as outer covering	Have feathers as outer covering	Have hair as outer covering
(2)	Lay eggs in water	Lay eggs on land	Give birth to young alive
(3)	Have no legs	Have two legs	Have four legs
(4)	Move away from danger by swimming	Move away from danger by flying	Move away from danger by running

17. The table below shows the characteristics of four animals, A, B, C and D. A tick (✓) shows that the animal has that characteristic.

Characteristic	A	B	C	D
Has feelers	✓			✓
Has six legs	✓			
Lays eggs	✓	✓	✓	✓
Has dry scales as its outer covering		✓		

The diagram below shows one of the animals.



Which letter best represents the animal shown above?

- (1) A
- (2) B
- (3) C
- (4) D

18. The table below shows the characteristics of four living things, W, X, Y and Z. A tick (✓) shows that the living thing has that characteristic.

Characteristic	W	X	Y	Z
Has fruits	✓			
Has leaves	✓		✓	✓
Grows on other plants		✓	✓	
Grows towards sunlight	✓		✓	✓

Based on the table, which statement about the four living things is not correct?

- (1) X is a fungus.
 - (2) Y is a fungus.
 - (3) W is a flowering plant.
 - (4) Z is a non-flowering plant.
19. Mr Johnson kept some guppies in his fish tank. He fed them daily with food and changed the water in the fish tank once a month. He recorded the number of guppies in the tank every two months, as shown in the table below. No guppies were added or taken out of the fish tank.

Month	Number of guppies in the fish tank
January	6
March	6
May	15
July	21
September	30

Based on the table above, what can Mr Johnson conclude about the guppies?

- (1) Guppies can die.
- (2) Guppies can reproduce.
- (3) Guppies can respond to changes.
- (4) Guppies need air, food and water to survive.

20. Rubber is used to make the tyres of the car while metal is used to make the body of the car as shown in the diagram below.

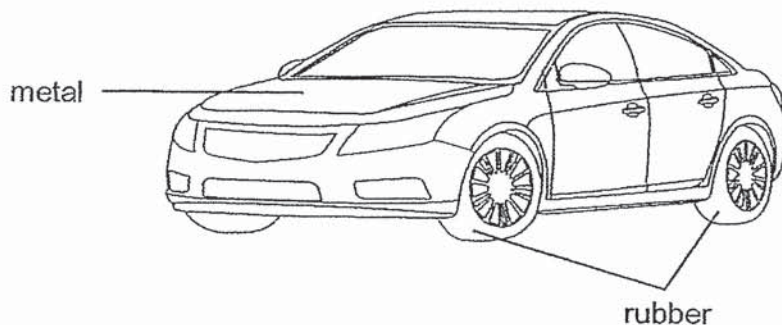

What properties of the materials made them suitable for making the parts of the car?

	Rubber	Metal
(1)	It is waterproof.	It allows light to pass through it.
(2)	It is flexible.	It is strong.
(3)	It floats on water.	It does not break easily.
(4)	It does not allow light to pass through it.	It is flexible.

21. The table below shows the properties of objects K, L, M and N.

Object	Allows light to pass through it	Can be bent easily without breaking
K	Yes	Yes
L	Yes	No
M	No	Yes
N	No	No

Which of the following objects is most likely to be a wooden ruler?

- (1) K
- (2) L
- (3) M
- (4) N

22. Jayden observed some materials and recorded his observations in the table below. A tick (✓) shows that the material has that property.

	Material			
Property	P	Q	R	S
Waterproof	✓	✓		
Flexible			✓	
Strong		✓		✓

Which material is most suitable for making a sink as shown in the diagram below?



- (1) Material P
- (2) Material Q
- (3) Material R
- (4) Material S

23. Mandy set up an experiment to measure the amount of light that can pass through four materials, W, X, Y and Z. She recorded her results in the table below.

(+ is used to indicate the amount of light measured)

Material	Amount of light that passed through it
W	++
X	+++
Y	+
Z	++++



Based on the information given in the table above, which material is most suitable for making part S of the spectacles for reading?

- (1) Material W
- (2) Material X
- (3) Material Y
- (4) Material Z

24. Lindy tested the strength of materials A, B, C and D by dropping a 2-kg weight from a height of 0.5 m, using the set-up as shown below. The materials were of the same size, thickness and shape.

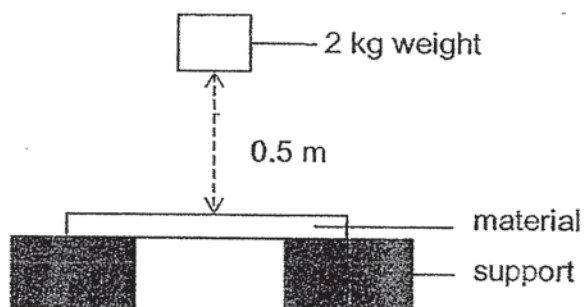

She noted the number of times the weight was dropped before the materials broke. Her results are shown in the table below.

Material	Number of drops before the material breaks
A	15
B	8
C	10
D	21

Based on the results in the table above, which of the following conclusions is correct?

- (1) Material A is the weakest material.
- (2) Material B is the strongest material.
- (3) Material C is weaker than material D.
- (4) Material D is weaker than material B.

End of Booklet A



NAN HUA PRIMARY SCHOOL
SEMESTRAL ASSESSMENT 1 – 2019
PRIMARY 3

SCIENCE

BOOKLET B

10 Open-ended questions (32 marks)

Total Time for Booklets A and B : 1 hour 30 minutes

INSTRUCTIONS TO CANDIDATES

1. Write your name and index number in the space provided.
2. Do not turn over the page until you are told to do so.
3. Follow all instructions carefully.
4. Answer all questions.
5. Write your answers in this booklet.

Marks Obtained

Section B

	/ 32
--	------

Name: _____ () Class: P 3 _____

Date : 15 May 2019

Parent's signature: _____

Section B: (32 marks)

Write your answers to questions 25 to 34 in the space provided. The number of marks allocated is shown in brackets [] at the end of each question or part of the question.

25. Gerald received a cat and a toy robot as presents from his grandparents. He likes to play with both his cat and his toy robot as they can move around.

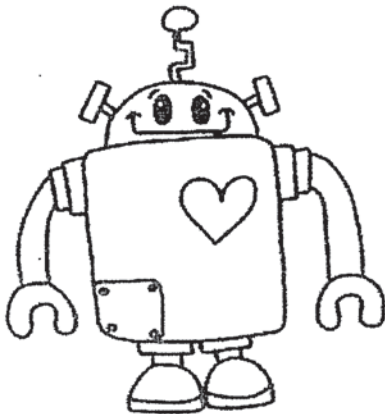

toy robot



cat

- (a) Gerald said that both are living things since they both can move around.

Do you agree with him? Explain your answer.

[1]

- (b) Gerald's cousin, Jane, came to his house over the weekend. When Jane saw the cat, she said that it is a mammal.

State two characteristics of a mammal.

[2]

- (i) _____
- (ii) _____

Score	3
-------	---

26. Michael found a sunflower plant, a soft toy and a fish in his friend's house.



sunflower



soft toy

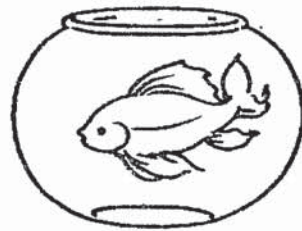

fish

He described their characteristics in the table below.

Characteristic	F	G	H
Can it grow?	Yes	No	Yes
Can it reproduce?	Yes	No	Yes
Can it move from place to place?	Yes	No	No

(a) Which letter, F, G or H, represents the sunflower? [1]

(b) Based on the table above, state one similarity between object G and object H. [1]

(c) Based on the table above, state one difference between object F and object G. [1]

Score	3
-------	---

27. The diagram below shows two groups of animals.

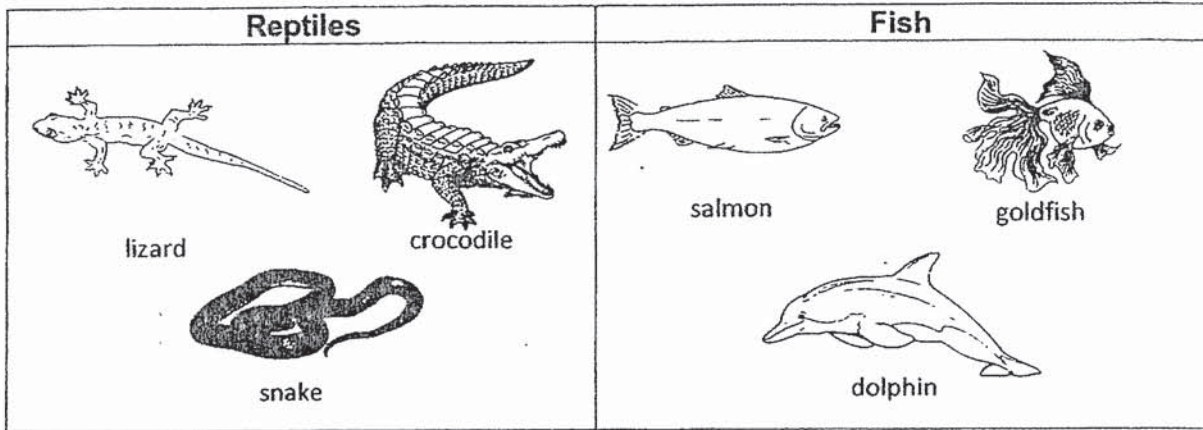

(a) Which animal has been wrongly classified? Give a reason for your answer. [1]

(b) State one similarity between reptiles and fish. [1]

(c) State two differences between reptiles and fish. [2]

(i)

(ii)

Score	4
-------	---

28. Some objects are placed into four groups according to the material that they are made of.

Group A	Group B	Group C	Group D
cooking pot	dress	mug	window pane
needle	bedsheet	flower pot	jug

(a) Identify the materials that are used to make the objects in each group. Each material can only be used once. [2]

metal	rubber	glass	ceramic	fabric
-------	--------	-------	---------	--------

Group	Material
A	
B	
C	
D	

(b) Name one property of the material that made it suitable for making the objects in Group B. [1]

(c) Name another material that can be used to make the objects in Group C. [1]

Score	4
-------	---

29. Fendi poured some water on six objects and observed what happened to the water.

Based on his observations, he classified the six objects into two groups as shown in the classification chart below.

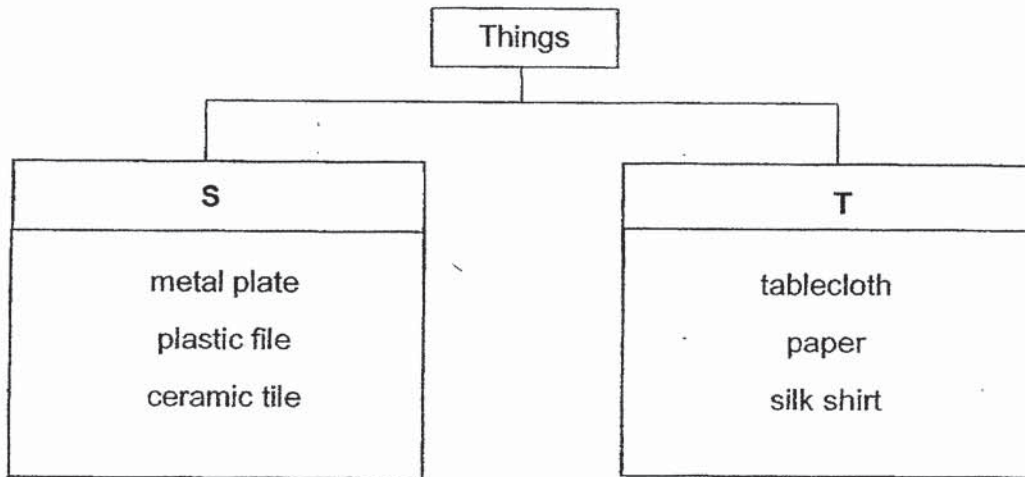

(a) Give suitable headings for Groups S and T. [1]

S: _____

T: _____

(b) Circle the object that can be placed in Group T. [1]



sponge

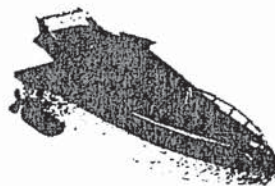

toy motorboat



spoon

Score	2
-------	---

30. Match the following observations to the correct characteristics of living things by joining the dots. [2]

Observations	Living things can...
(a) An insect lays eggs on a leaf. ●	● move by themselves
(b) A mouse looks for food. ●	● grow
(c) The leaves of the mimosa plant closed up when touched. ●	● reproduce
(d) A boy becomes taller. ●	● respond to changes

6

Score	2
-------	---

31. The diagrams below show two animals, P and Q.



Animal P



Animal Q

(a) Complete the table below.

[2]

		Animal P	Animal Q
(i)	Reproduction method		
(ii)	Animal group		

(b) Animals P and Q have been placed in the same group in the classification chart below.

Classify the four animals given below into the two groups in the chart. Give suitable headings for each group. [2]

human	parrot	butterfly	cat
-------	--------	-----------	-----

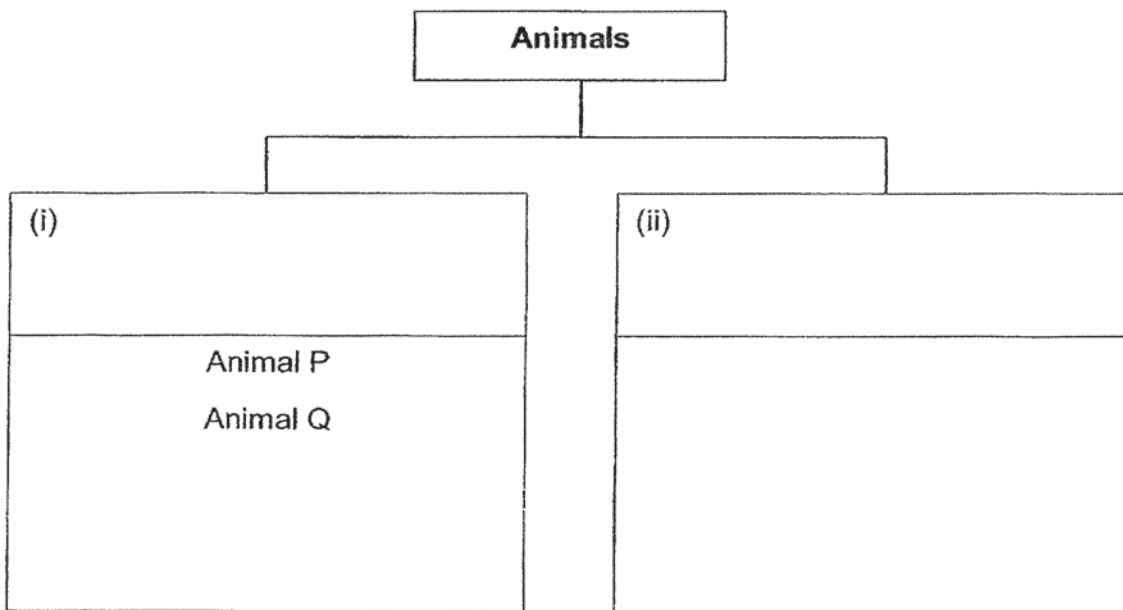

7

Score	4
-------	---

32. Study the flowchart below.

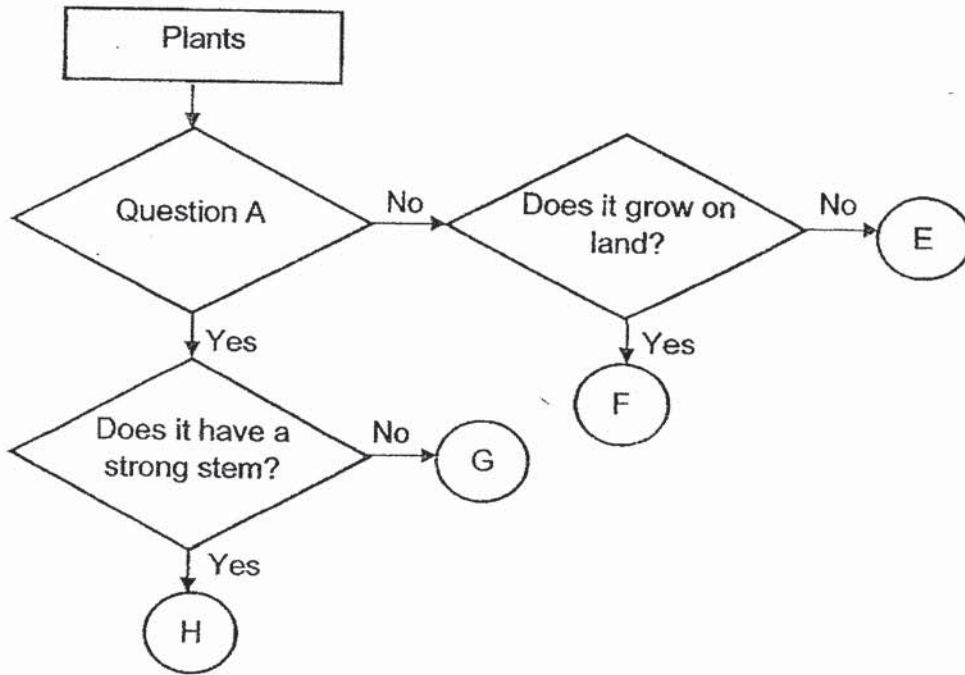

The diagrams below show plants F and H from the flowchart above.



Plant F

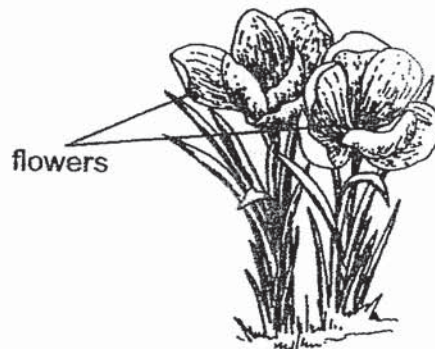

Plant H

(a) Based on the diagrams above, what could question A in the flowchart be? [1]

Score	1
-------	---

The diagram below shows a plant.

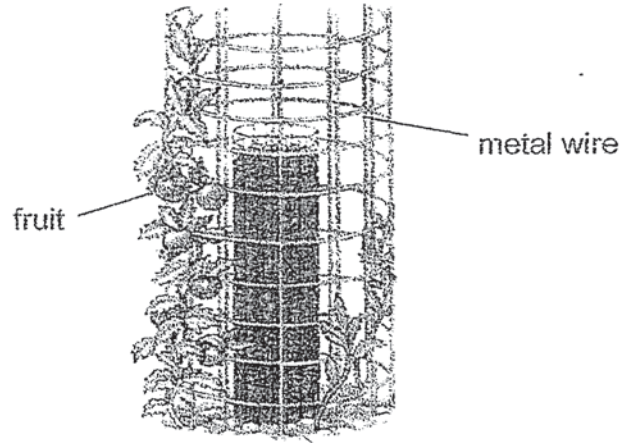

- (b) Based on the flowchart, which letter, E, F, G or H, best represents the plant shown above? [1]
-

Score	1
-------	---

33. David has a high chair, as shown in the diagram below, for feeding his child.

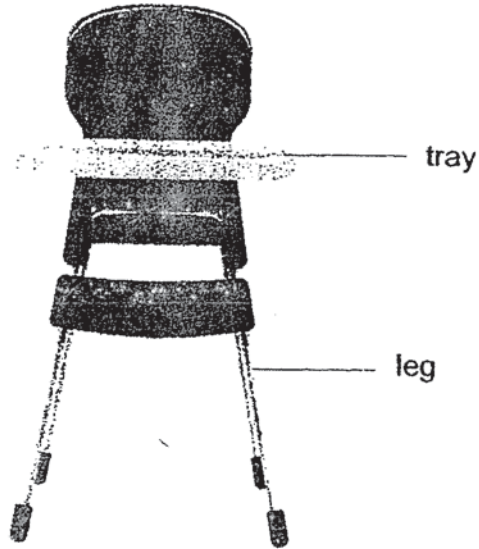

(a) Glass is not used to make the tray. State one material that is suitable for making the tray. [1]

(b) What physical property of the material in part (a) made it more suitable for making the tray than glass? [1]

(c) The high chair is supported by the legs. Explain why metal is suitable for making the legs of the high chair to ensure the safety of the child? [2]

Score	
	4

34. Study the flowchart below.

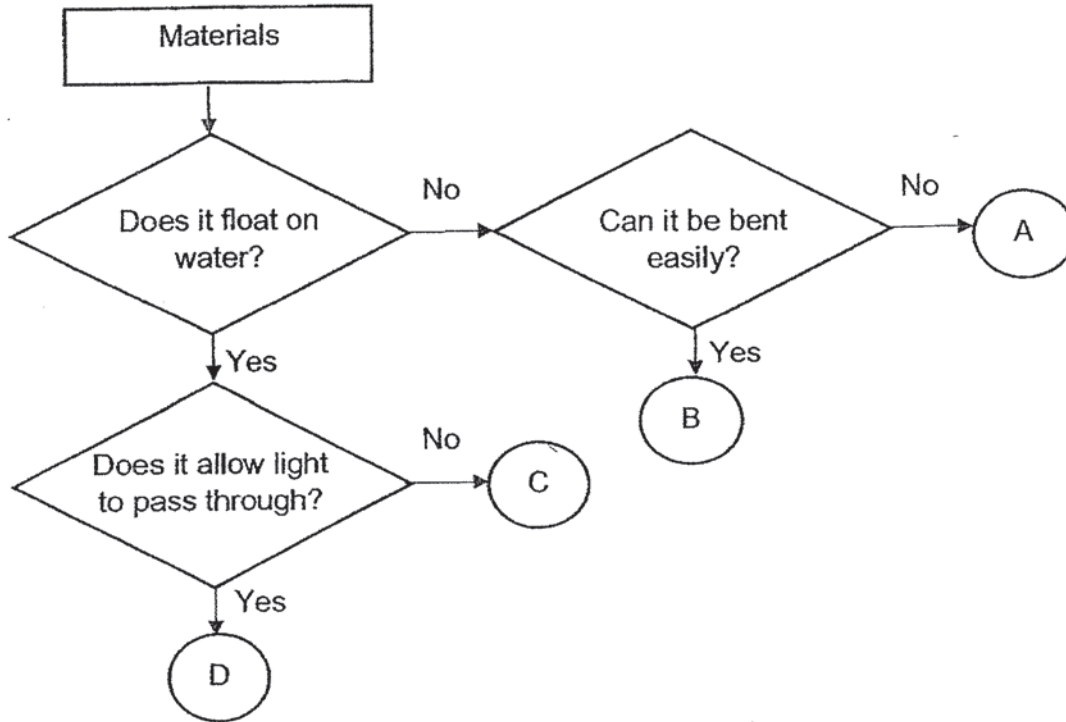

(a) Using the information above, state one property of material A. [1]

(b) Using the information above, state one difference between material C and material D. [1]

Score	2
-------	---

Harry set up an experiment to test the ability of four objects to float on water. The diagram below shows what he observed.

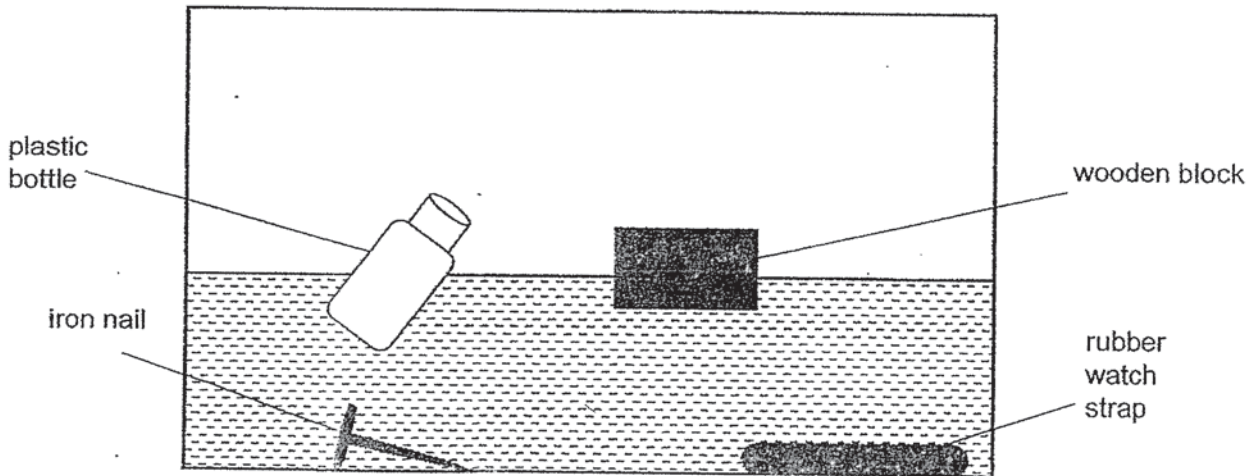

- (c) Based on Harry's observations, identify which material from the flowchart is used to make each object. Write **A**, **B**, **C** and **D** in the table below. Each letter can only be used once. [2]

Object	Material
plastic bottle	
iron nail	
wooden block	
rubber watch strap	

End of Booklet B

12

Score	2
-------	---

ANSWER KEY

YEAR : 2019
LEVEL : PRIMARY 3
SCHOOL : NAN HUA PRIMARY SCHOOL
SUBJECT : SCIENCE
TERM : SEMESTRAL ASSESSMENT 1

Q1	Q2	Q3	Q4	Q5	Q6	Q7	Q8	Q9	Q10
3	3	2	4	2	3	4	1	2	4
Q11	Q12	Q13	Q14	Q15	Q16	Q17	Q18	Q19	Q20
2	3	1	2	4	4	1	2	2	2
Q21	Q22	Q23	Q24						
4	2	4	3						

Q25. (a) No. the toy robot is not a living thing as it does not need air, food and water to survive.

(b) (i) It has hair.

(ii) It is warm-blooded

Q26. (a) The letter H represents the sunflower.

(b) Both objects cannot move from place to place.

(c) Object F can grow but object G cannot grow.

Q27. (a) The dolphin is wrongly classified. Fishes have scales but the dolphin have hair.

(b) Both reptiles and fish have scales.

(c) (i) Fish have fins but reptiles do not have.

(ii) Reptiles breathe through lungs but fishes breathe through gills.

Q28. (a) A: metal B: fabric C: ceramic D: glass

(b) flexible

(c) plastic

Q29. Waterproof

Not waterproof

(b) sponge

Q30. (a) (b) (c) (d)

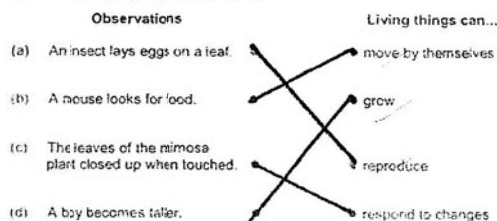

Q31. (a)

(i)	reproduce by laying eggs	reproduce by young alive
(ii)	insects	mammals

Q31.(b)

(i) Have wings	(ii) No lungs
butterfly	human
parrot	cat

Q32. (a) Does it bear flowers?

(b) Letter G

Q33. (a) Plastic

(b) It does not break as easily as glass.

(c) Metal is strong and can support the weight of the child.

Q34. (a) It cannot be bent easily.

(b) Material D allows light to pass through but material C does not allow light to pass through.

(c) plastic bottle: D

Iron nail: A

Wooden block : C

Rubber watch strap: B

2

2/10