

Pei Chun Public School
Continual Assessment – 2009
Mathematics
Primary 4

Booklet A

Name: _____ ()

Date: 26 August 2009

Class: Primary 4 ____

Time: 2 h

Maths Teacher: _____

Questions 1 to 12 carry 2 marks each. For each question, four options are given. One of them is the correct answer. Make your choice (1, 2, 3 or 4) and write its number in the brackets provided. (24 marks)

1. In 47 513, the digit 7 is in the _____ place.

- (1) tens
- (2) hundreds
- (3) thousands
- (4) ten thousands ()

2. Round off 82 359 to the nearest hundred.

- (1) 82 000
- (2) 82 300
- (3) 82 360
- (4) 82 400 ()

3. 6 hundreds, 3 ones, 9 tenths and 1 hundredth is _____.

- (1) 63.91
- (2) 603.91
- (3) 630.91
- (4) 6391 ()

4. $2.004 = 2 + \frac{4}{\square}$

What is the missing number in the box?

- ~~(1)~~ 1
~~(2)~~ 10
~~(3)~~ 100
~~(4)~~ 1000

()

5. Which of the following has 6 as a factor?

- ~~(1)~~ 28
~~(2)~~ 32
~~(3)~~ 48
~~(4)~~ 56

()

6. Find the value of $3\frac{5}{8} + 1\frac{7}{4}$.

- (1) $3\frac{6}{8}$
 (2) $3\frac{7}{8}$
 (3) $4\frac{6}{8}$
 (4) $4\frac{7}{8}$

()

7. A movie lasting 2 h 10 min ended at 02 30. At what time did the movie start?
Give your answer in 24-hour time.

(1) 00 20

(2) 04 40

(3) 12 20

(4) 16 40

()

8. The figure below is made up of a square and a rectangle.

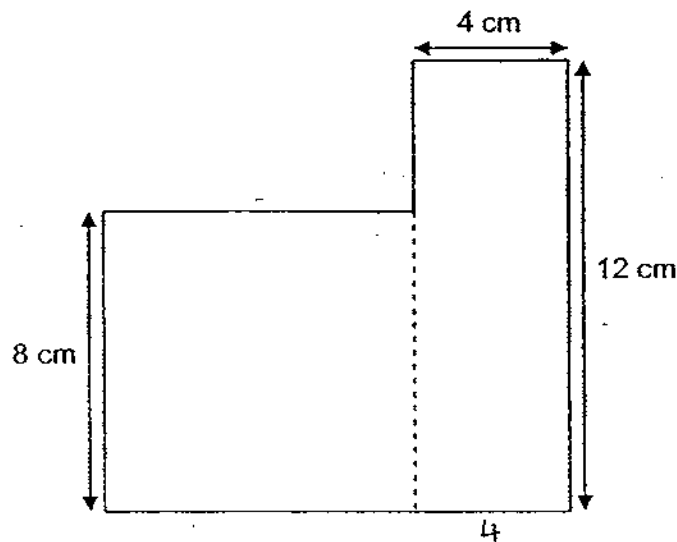

What is the perimeter of the figure?

(1) 48 cm

(2) 56 cm

(3) 64 cm

(4) 112 cm

()

9. There are 45 beads in a packet. $\frac{3}{5}$ of them are blue and the rest are red.
How many red beads are there?

(1) 9

(2) 15

(3) 18

(4) 27

()

10. Amy is facing the school. She makes a $\frac{3}{4}$ -turn in an anti-clockwise direction. She is now facing the _____.

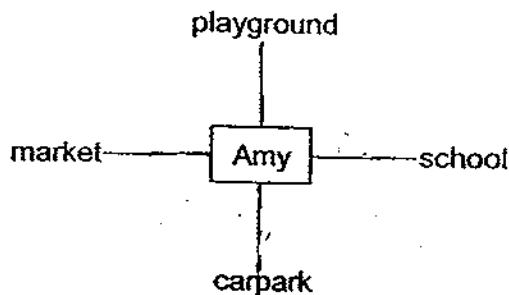

- (1) carpark
 (2) market
 (3) playground
 (4) school ()
11. Jack has 4 times as much money as Sarah. He has \$24 more than Sarah. How much money does Sarah have?
- (1) \$6
 (2) \$8
 (3) \$30
 (4) \$32 ()
12. Box A contains 112 marbles. Box B contains 7 times as many marbles as Box A. Box C contains 129 more marbles than Box B. How many marbles are there in Box C?
- (1) 145
 (2) 655
 (3) 784
 (4) 913 ()
13. Refer to Booklet K.
 14. Refer to Booklet K.
 15. Refer to Booklet K.

End of Booklet A

Pei Chun Public School
Continual Assessment - 2009
Mathematics
Primary 4

Booklet B

Name : _____ ()

Marks :

Class : Primary 4 ___

Date : 26 August 2009

Time : 2 h

Maths Teacher : _____

Parent's Signature : _____

Booklet A	/	24
Booklet B	/	56
Booklet K <small>Qn 13-15, 28-30, 39-40</small>	/	20
TOTAL	/	100

Questions 16 to 27 carry 2 marks each. Show your working clearly in the space below each question and write your answers in the spaces provided.
For questions which require units, give your answers in the units stated.

Do not write in this space

(24 marks)

16. Write 91 405 in words.

Ans: _____

17. Complete the following pattern:

26 230, 26 080, _____, 25 780, 25 630

Ans : _____

SCORE

18. Find the value of $540 \div 8$. Express your answer in **decimals**.

Ans : _____

19. Find the value of $163.8 - 47.95$.

Ans : _____

20. Arrange the following fractions from the smallest to the greatest.

$$\frac{2}{3}, \quad \frac{7}{9}, \quad \frac{4}{9}$$

Ans : _____

21. Measure and write down the size of $\angle a$.

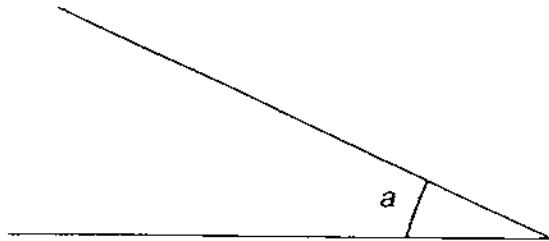

Ans : _____ °

SCORE

22. Express $4\frac{5}{7}$ as an improper fraction.

Ans : _____

23. Find the value of $\frac{4}{12} - \frac{4}{4}$.

Ans : _____

24. There are _____ halves in $4\frac{5}{10}$.

Ans : _____

25. The letter A represents a mixed number. What is the mixed number?

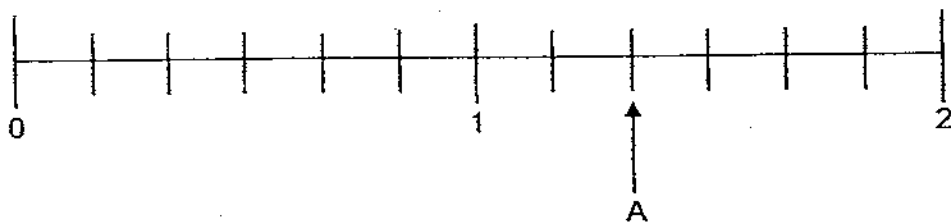

Ans : _____

Do not write in this space

SCORE

26. When Shuyi is 10 years old, her father is 5 times as old as she. How old will Shuyi be when her father is 3 times as old as she?

Do not v
in this s

Ans : _____ years old

27. The perimeter of Rectangle A is the same as the perimeter of Square B. Find the area of Square B.

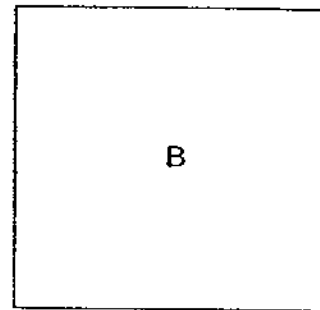
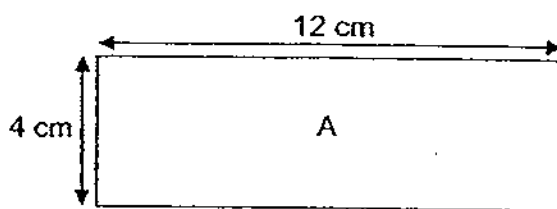
Ans : _____ cm²

28. Refer to Booklet K.
29. Refer to Booklet K.
30. Refer to Booklet K.

SCORE

Questions 31 to 38 carry 4 marks each. Show your working clearly in the space below each question and write your answers in the spaces provided. (32 marks)

Do not write in this space

31. (a) Draw a line perpendicular to line EF passing through the point G. [2]

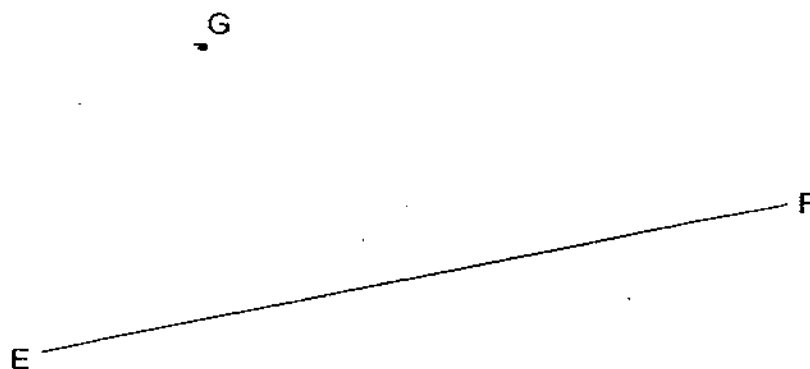

- (b) Draw a line parallel to LM passing through the point N. Draw arrowheads to show that the lines are parallel. [2]

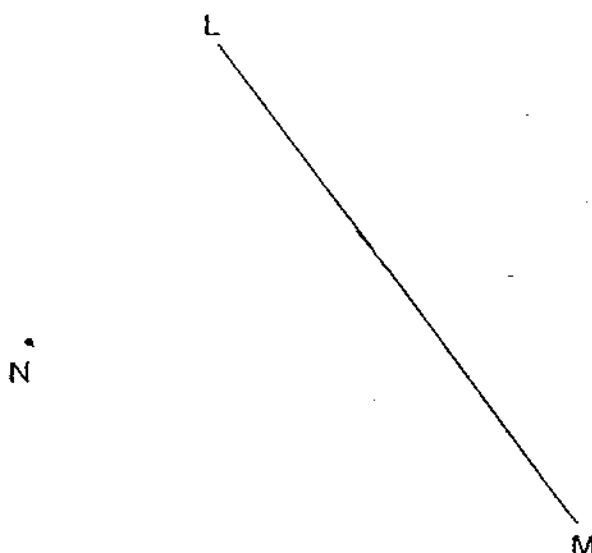

SCORE

32. Machine A can print 130 cards in a minute. Machine B can print 50 more cards a minute than Machine A. Find the total number of cards both machines can print in 42 minutes.

Do not write
in this space

Ans : _____ [4]

SCORE

33. Tony and Ali have a total of 9274 stamps. Tony has 2508 more stamps than Ali. How many stamps does Tony have?

Do not write in this space

Ans : _____ [4]

SCORE

34. Kathy had a ribbon 407 cm long. She gave 80.6 cm of the ribbon to her friend. She used some of the remaining ribbon to tie up 7 boxes and had 21.9 cm of ribbon left. She used an equal length of ribbon to tie up each box. What was the length of ribbon Kathy used to tie up each box?

Do not
in this:

Ans : _____ [4]

SCORE

35. There are 144 chocolate, strawberry and vanilla muffins in a bakery altogether.
 $\frac{5}{8}$ of the muffins are chocolate muffins. 29 muffins are strawberry muffins and the rest are vanilla muffins. How many vanilla muffins are there?

Do not write in this space

Ans : _____ [4]

SCORE

36. A TV set cost as much as 2 identical cameras. 2 such TV sets and 5 such cameras cost \$3437.10. If Mr Fong bought a TV set and paid the cashier \$800, how much change would he get?

Do not write in this space

Ans : _____ [4]

SCORE

37. Mr Kam sold a total of 96 papayas and watermelons for \$560. He sold each papaya for \$3 and each watermelon for \$7. How many watermelons did Mr Kam sell?

Do not write in this space

Ans : _____ [4]

SCORE

38. $\frac{2}{3}$ of Deva's stickers is equal to $\frac{1}{3}$ of Rahim's stickers. They have 216 stickers altogether. How many stickers must Rahim give Deva so that they will have an equal number of stickers?

Do not write in this space

Ans : _____ [4]

39. Refer to Booklet K.

40. Refer to Booklet K.

End of Booklet B

Set by : Mr Terence Ong
Vetted by: P4 Maths Committee Teachers

SCORE

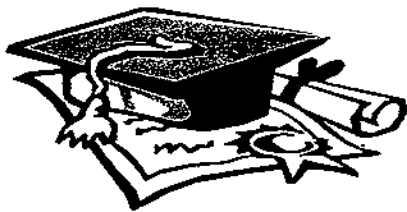

ANSWER SHEET

EXAM PAPER 2009

SCHOOL : PEI CHUN PRIMARY
SUBJECT : PRIMARY 4 MATHEMATICS

TERM : CA2

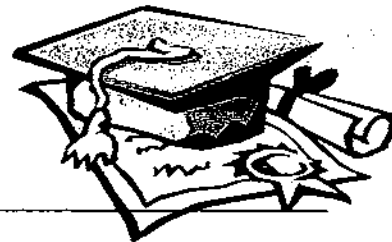

Q1	Q2	Q3	Q4	Q5	Q6	Q7	Q8	Q9	Q10	Q11	Q12
3	4	2	4	3	4	1	1	3	1	2	4

16) Ninety-one thousand, four hundred and five 17) 25930 18) 67.5

19) 115.85 20) $\frac{4}{9}$, $\frac{2}{3}$, $\frac{7}{9}$ 21) 25° 22) $\frac{33}{7}$ 23) $\frac{1}{12}$

24) 9 25) $1\frac{1}{3}$ 26) 20 years old 27) 64cm^2

31)a)

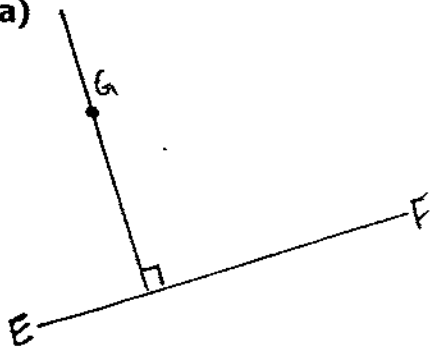

b)

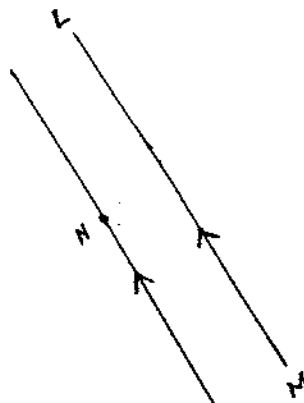

32) Machine A $\rightarrow 130 \times 42 = 5460$
 Machine B $\rightarrow 130 + 50 = 180$
 $180 \times 42 = 7560$
 Total $\rightarrow 5460 + 7560 = 13020$

33) $9274 - 2508 = 6766$
 $6766 \div 2 = 3383$
 $3383 + 2508 = 5891$ stamps.

**34) $407 - 80.6 - 21.9 = 326.4$
 $326.4 - 21.9 = 304.5$
 $304.5 \div 7 = 43.5\text{cm}$**

**35) 1 unit $\rightarrow 144 \div 8 = 18$
1 - $\frac{5}{8} = \frac{3}{8}$
18 units $\rightarrow 18 \times 3 = 54$
Vanilla $\rightarrow 54 - 29 = 25$ vanilla muffins.**

**36) 9 units $\rightarrow \$3437.10$
1 unit $\rightarrow \$3437.10 \div 9 = \381.90
2 units $\rightarrow \text{TV} \rightarrow \$381.90 \times 2 = \$763.80$
 $\$800 - \$763.80 = \$36.20$**

**37) $3 \times 96 = 288$
 $560 - 288 = 272$
 $272 \div 4 = 68$ watermelons.**

**38) 9 units $\rightarrow 216$
1 unit $\rightarrow 216 \div 9 = 24$
3 units $\rightarrow 24 \times 3 = 72$
 $72 \div 2 = 36$ stickers.**