



AI TONG SCHOOL

2007 SEMESTRAL ASSESSMENT (2) PRIMARY FOUR SCIENCE

DURATION : 1hr 45 min

DATE: 29th October 2007

INSTRUCTIONS

**Do not open the booklet until you are told to do so.
Follow all instructions.
Answer all questions.**

Name: _____ ()

Class : Primary 4 _____

Parent's Signature: _____

Date : _____

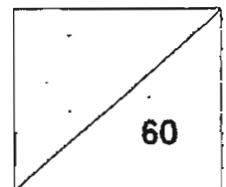

Section A (30 x 2 marks)

For each question from 1 to 30, four options are given. One of them is the correct answer. Make your choice (1, 2, 3 or 4). **Shade the correct oval (1, 2, 3 or 4) on the Optical Answer Sheet.**

1. Based on the pictures below, which one of the following statements is true?



1 kg of feathers



1 kg of sand

- (1) The sand has a greater mass than the feathers.
- (2) The sand has a larger volume than the feathers.
- (3) The feathers have a greater mass than the sand.
- (4) The feathers have a larger volume than the sand.

2. The table below shows the properties of substances A, B, C or D.

Properties	A	B	C	D
Has mass	Yes	Yes	Yes	Yes
Can be compressed	No	Yes	Yes	No
Has a definite shape	No	Yes	No	Yes
Has a definite volume	Yes	No	No	Yes

Which one of the following substances A, B, C or D represent water vapour?

- (1) A
- (2) B
- (3) C
- (4) D

3. Maria used a lever balance to compare the mass of objects W, X, Y and Z. The 4 objects are of the same size and shape.

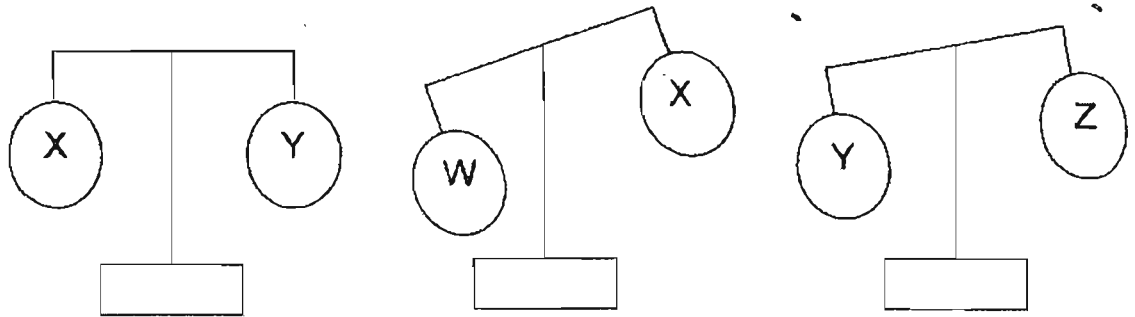

Which object has the smallest mass?

- (1) W
 - (2) X
 - (3) Y
 - (4) Z
4. The table below shows the average total amount of water used by four families at the end of the month. All the four families attended a water conservation talk at the end of May...

Family	Average total amount of water (m^3) used in			
	April	May	June	July
Tan	50	55	52	45
Lim	55	58	62	65
Ahmad	52	50	58	60
Mohan	50	53	50	47

Which of the families showed that they had learnt water conservation through the talk?

- (1) Tan and Ahmad
- (2) Tan and Mohan
- (3) Lim and Ahmad
- (4) Lim and Mohan

5. Mei Mei set up an experiment as shown below. She put an equal number of duckweeds in beakers A, B, C and D. She placed the beakers in a bright place for 5 days.

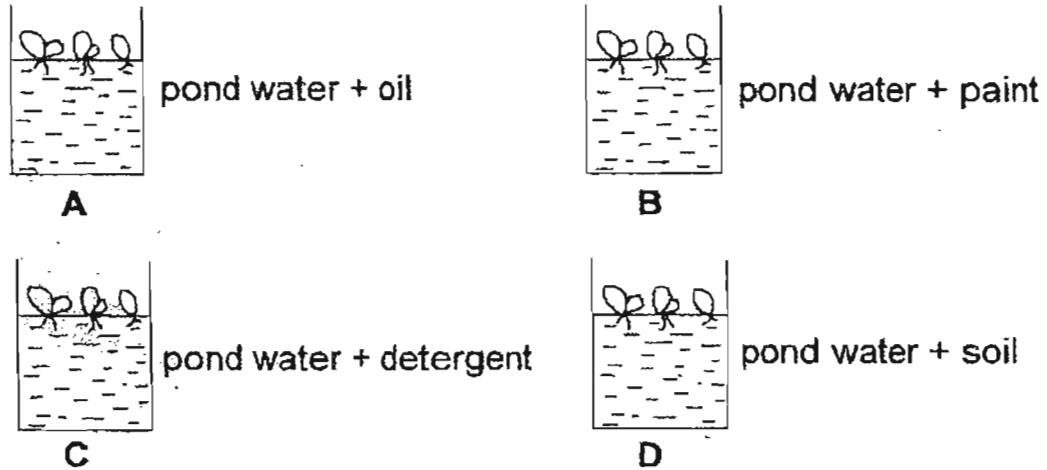

In which beaker would she observe an increase in the number of duckweeds?

- (1) A
 (2) B
 (3) C
 (4) D
6. Which processes are put under the wrong headings?

Heat Loss

Heat Gain

- | | |
|------------------|-------------|
| (1) boiling | evaporation |
| (2) freezing | boiling |
| (3) freezing | melting |
| (4) condensation | evaporation |

7. Which one of the following pie charts shows the correct composition of gases in the air?

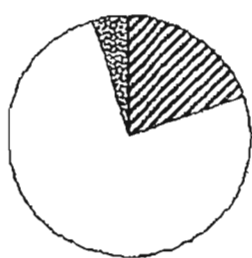

A

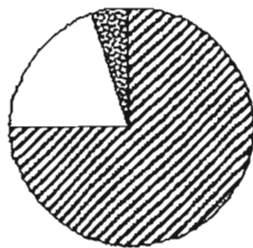

B

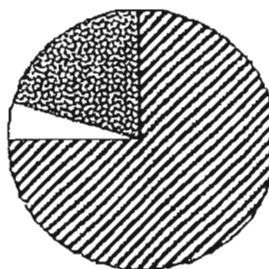

C

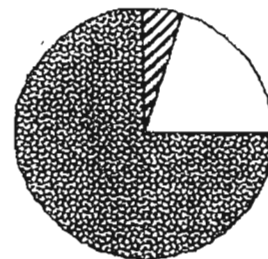

D

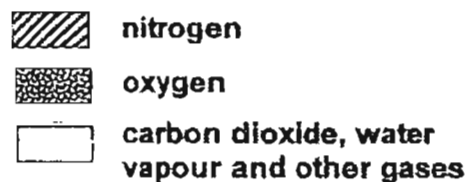

- (1) A
- (2) B
- (3) C
- (4) D

8. Which of the following gases is correctly matched with its description?

Gas	Description
Oxygen	We need it during respiration.
Nitrogen	Plants absorb it through the stomata.
Water vapour	Clouds are made up of this.
Carbon dioxide	It will be used up during burning.

- (1) Oxygen
- (2) Nitrogen
- (3) Water vapour
- (4) Carbon dioxide

9. Which one of the following animals has a different breathing method?

- (1) Bat
- (2) Dog
- (3) Shark
- (4) Whale

10. Muthu set up an experiment as shown below. He blew into the inverted plastic bottle through the hose.

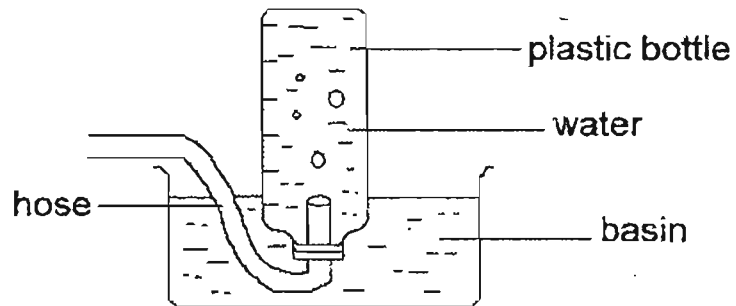

What changes did Muthu observe?

- A: The water level in the basin went up.
- B: The water level in the basin went down.
- C: The water in the plastic bottle turned cloudy.
- D: The water level in the plastic bottle went down.

- (1) A and C
- (2) A and D
- (3) B and C
- (4) B and D

11. The air that we breathe out contains _____ than the air we breathe in.

- (1) more heat
- (2) more oxygen
- (3) less water vapour
- (4) less carbon dioxide

12. Our blood transport _____ to the lungs and all other parts of our body.

- A: carbon dioxide
- B: digested food
- C: oxygen
- D: water

- (1) A, B and C
- (2) A, B and D
- (3) B, C and D
- (4) A, B, C and D

13. Which one of the following statements is not true about our heart?

- (1) It is conical in shape.
- (2) It is a spongy tissue.
- (3) It can contract and relax continuously.
- (4) It continues to beat even when we are sleeping.

14. The graph shows Tim's pulse rate over an hour during which he strolled to the park for a jog.

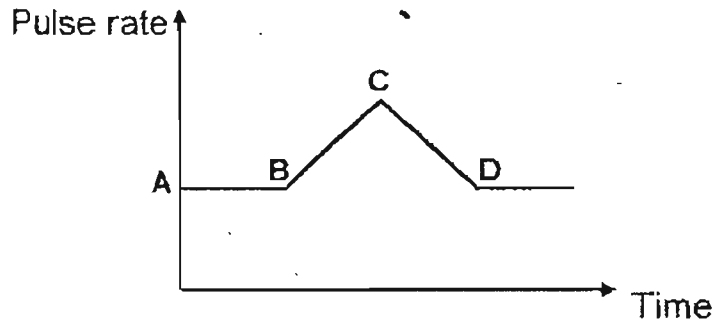

At which point did he stop jogging?

- (1) A
- (2) B
- (3) C
- (4) D

15. Study the diagram below.

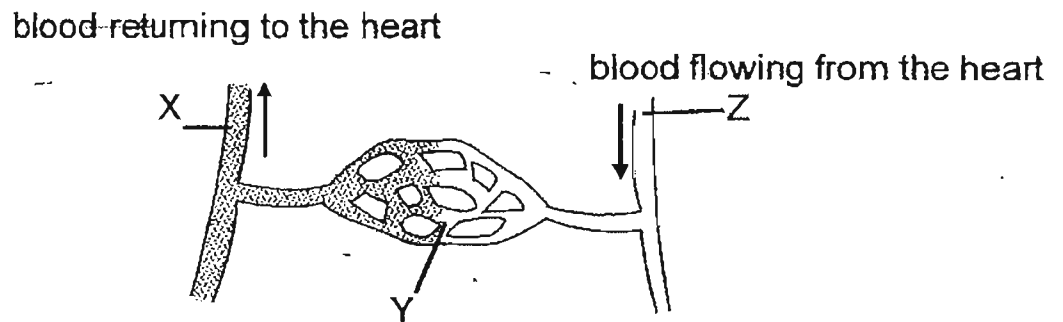

Which types of blood vessels are A, B and C likely to be?

	X	Y	Z
(1)	vein	capillary	artery
(2)	vein	artery	capillary
(3)	artery	capillary	vein
(4)	capillary	artery	vein

16. When a ray of light from a torch is shone onto Object X, a dark shadow is formed on the wall. Object X is most likely to be a _____.

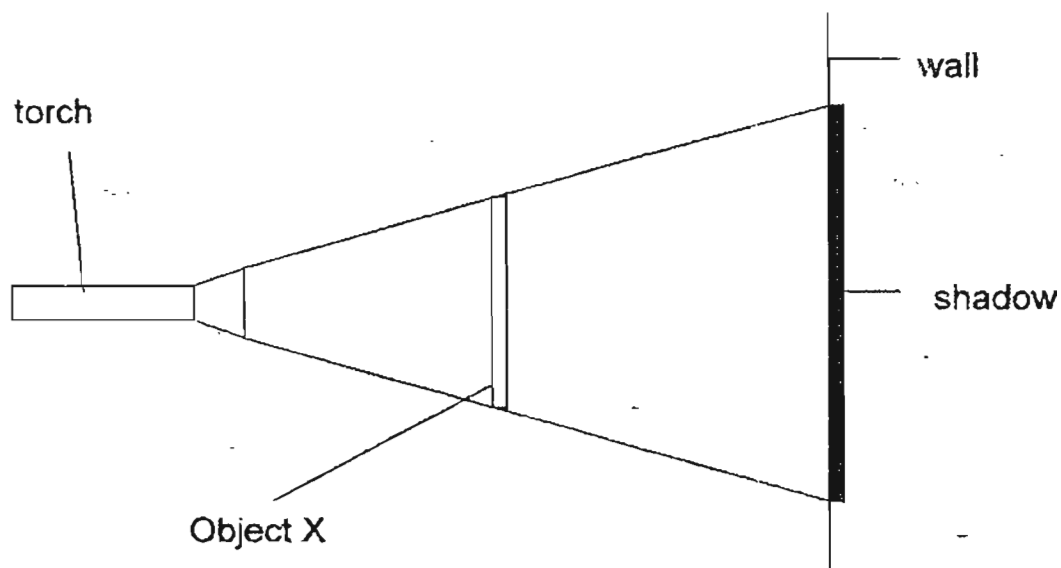

- (1) thin mirror
 - (2) clear spectacle lens
 - (3) translucent piece of glass
 - (4) transparent piece of plastic
17. Which of the following processes involve heat energy?

- A: Baking a cake.
- B: Ironing clothes.
- C: Melting butter on a plate.
- D: Setting jelly in a refrigerator.

- (1) A and D only
- (2) C and D only
- (3) A, B and C
- (4) A, B, C and D

18. Which of the following gives out light?

- A: Fire
- B: Stars
- C: Lightning
- D: The Moon

- (1) A and C only
- (2) A and B only
- (3) B and D only
- (4) A, B and C only

19. Which of the following statements about the Sun are correct?

- A: The Sun is our main source of heat and light.
- B: The energy from the Sun is the source of all food energy.
- C: The energy from the Sun enables the water cycle to go on.
- D: The energy from the Sun is passed from animals to plants.

- (1) A and C
- (2) A and B
- (3) A, B and C
- (4) A, B, C and D

20.

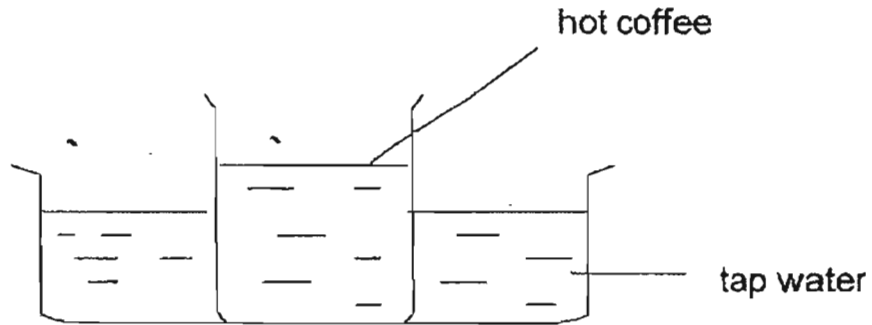

In the diagram above, a beaker of hot coffee is placed in a basin of tap water. After some time, the _____.

- A: coffee loses heat
- B: tap water loses heat
- C: coffee gains heat
- D: tap water gains heat

- (1) A only
- (2) B only
- (3) A and D only
- (4) B and C only

21. Which of the following statements about energy are correct?

- A: It is a kind of matter.
- B: It enables things to move.
- C: It has a definite volume.
- D: It can be transferred from one place to another.

- (1) B and D only
- (2) A and B only
- (3) B, C and D only
- (4) A, B, C and D

22. Tom set up a mirror and shone a torch onto it. Which one of the following diagrams shows the correct path of the ray of light reflected by the mirror?

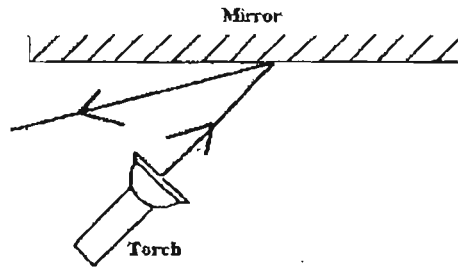

(1)

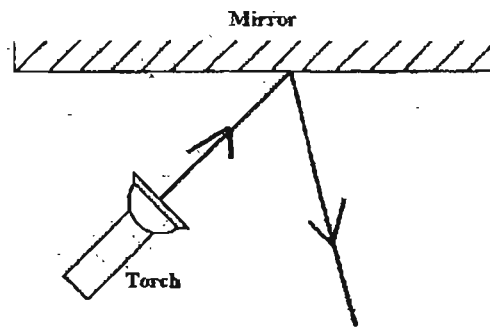

(2)

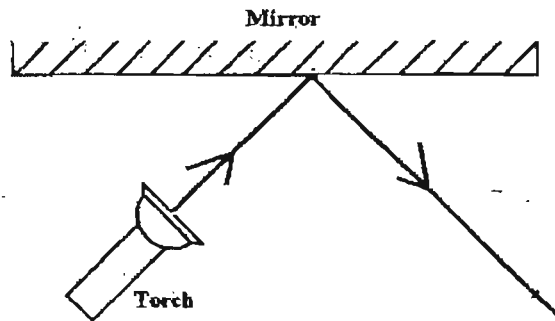

(3)

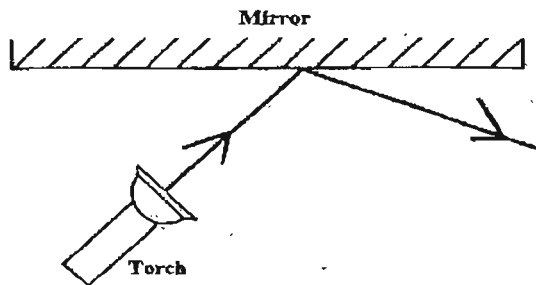

(4)

23. A pupil carried out an experiment. He set up the apparatus as shown in the diagram below.

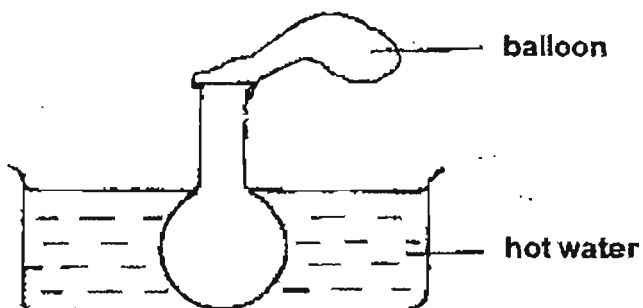

After some time, he observed that the balloon had inflated. This happened because _____ expands when heated.

- (1) air
- (2) water
- (3) the balloon
- (4) the bottle

24. Mark had two beakers of water containing equal amount of water.

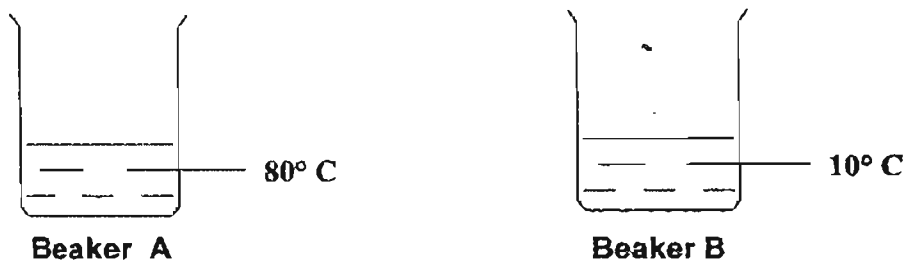

Mark then poured the water from Beaker A and Beaker B into Beaker C,

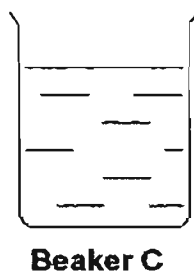

The temperature of the water in Beaker C would be _____

- (1) less than 10°C
- (2) more than 80°C
- (3) less than 80°C but more than 10°C
- (4) more than 80°C but less than 100°C

25. Which one of the following can reduce the strength of a magnet?

- A: Dropping the magnet
- B: Heating the magnet.
- C: Hammering the magnet.

- (1) A and B only
- (2) A and C only
- (3) B and C only
- (4) A,B and C

26. The classification chart shows 2 groups of materials.

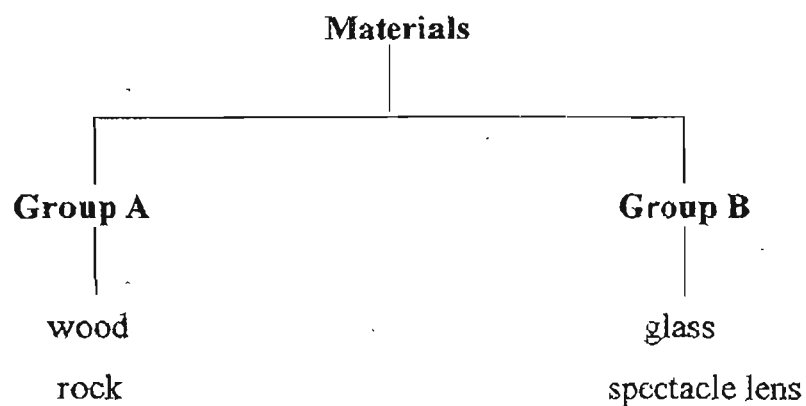

Which of the following correctly describes the materials in each group?

	Group A	Group B
1)	Magnetic	Non-magnetic
2)	Smooth	Rough
3)	Opaque	Transparent
4)	Made from animal	Made from plant

27. The diagram below shows the characteristics of Organism Y.

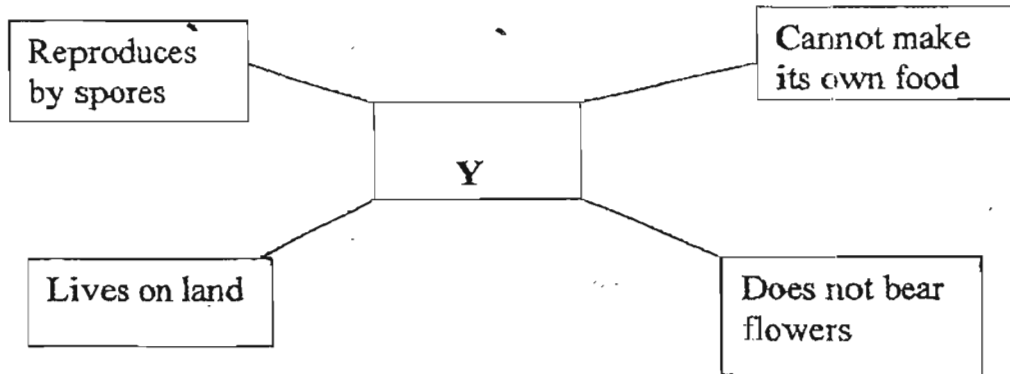

Which one of the following **cannot** be Organism Y?

- (1) moss
- (2) mould
- (3) toadstool
- (4) bracket fungi

28. The flow chart below shows the characteristics of four animals A, B, C and D.

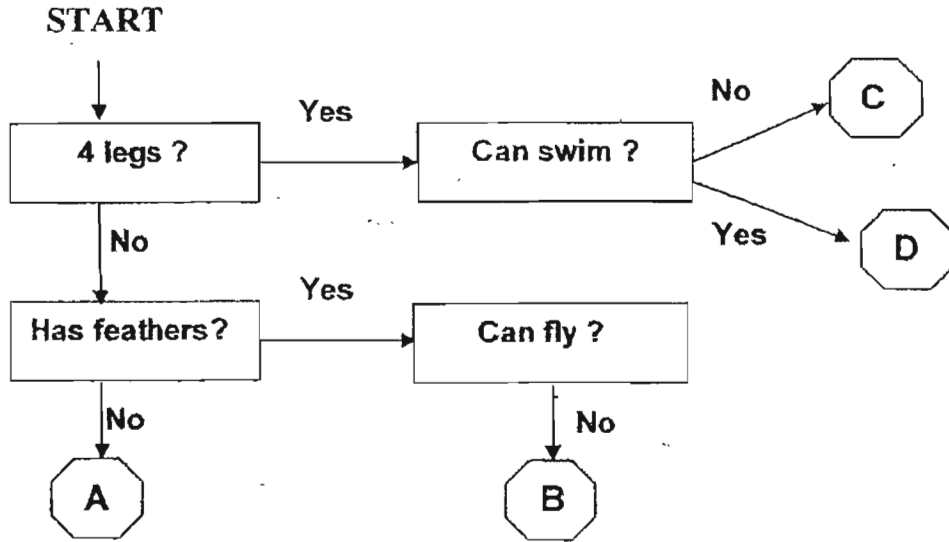

Which of the following groups of animals are likely to be Animals A, B, C and D?

	Animal A	Animal B	Animal C	Animal D
1)	butterfly	crow	lion	frog
2)	fish	eagle	bat	turtle
3)	sealion	penguin	wolf	toad
4)	penguin	ostrich	platypus	crab

29. The diagram below shows a glass tube connecting two test tubes X and Y.

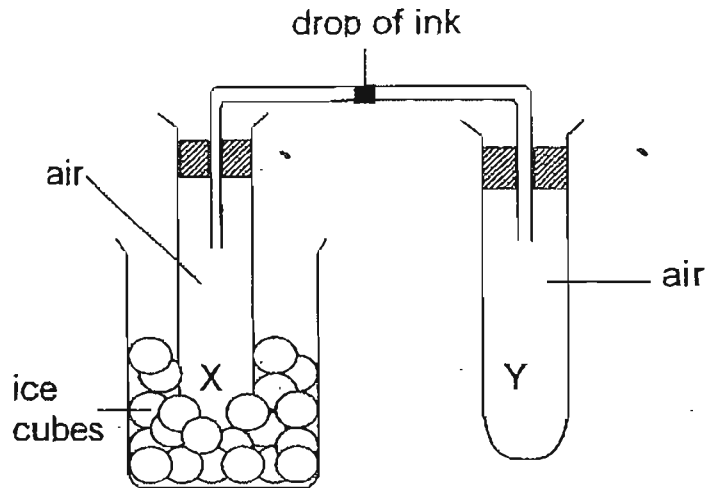

If test tube X is placed in a beaker containing ice cubes, the drop of ink will _____.

- 1) expand
 - 2) will not move
 - 3) move towards X
 - 4) move towards Y
30. Which of the following comparisons between the life cycle of a mosquito and that of a butterfly are correct?

		Mosquito	Butterfly
A	Lays eggs in water	Yes	No
B	Has 4 stages in its life cycle	Yes	Yes
C	The young resembles the adult	No	Yes
D	It is a pest during the larval stage	Yes	No

- (1) A and B only
- (2) B and C only
- (3) A and D only
- (4) C and D only

Primary 4 Science Semestral Assessment 2 (2007)

Name: _____ ()

Class: P4 ()

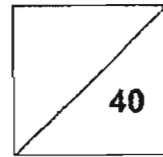

Section B: 40 marks

Answer all the questions in the spaces provided.

31. The diagram below shows the digestive system of a man.

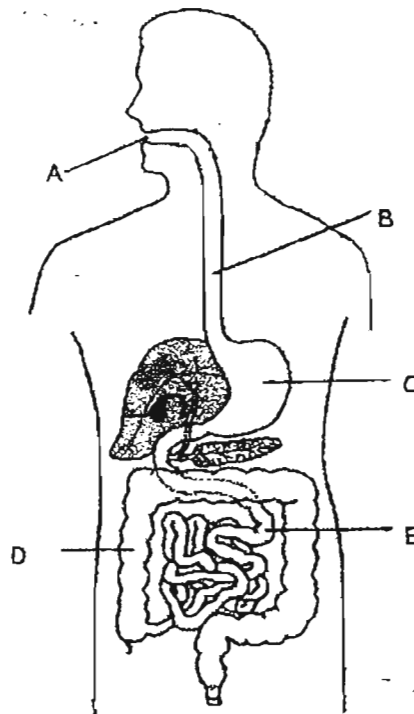

Study the diagram carefully and complete the sentences below with the correct letters.

- (a) Food takes the longest time to be digested at _____. [1]
- (b) Water is taken away from the undigested food at _____. [1]
- (c) Digested food passes into the blood stream at _____. [1]

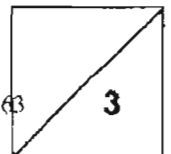

32. The diagram below shows an example of a joint found in our body.



(a) What is the name of this kind of joint? [1]

(b) Name one part of the body where this kind of joint can be found. [1]

33. Some boys covered a block of ice with sawdust as shown in the diagram below.

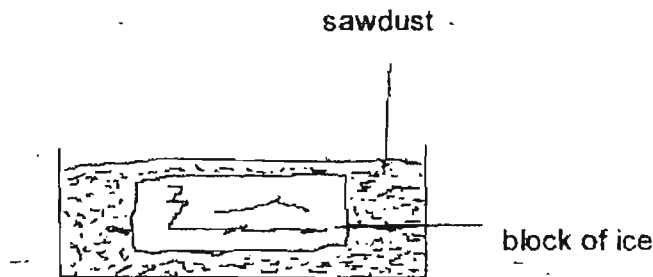

(a) How does the sawdust prevent the ice from melting quickly? [1]

(b) What other material can the boys put in the box to prevent the ice from melting quickly? [1]

34. Some ice cubes are placed in the beaker to be heated. The graph below shows the change in temperature of water over a short period of time.

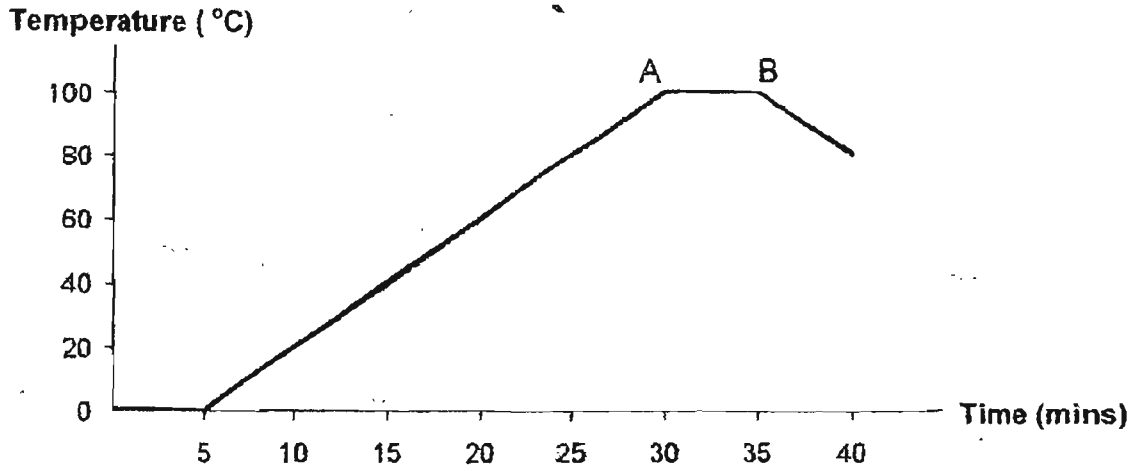

- (a) What is the change of state of the ice cubes during the first 5 minutes? [1]

- (b) What processes are taking place at AB? [1]

(i) _____

(ii) _____

- (c) What could have caused the temperature to drop after thirty-five minutes? [1]

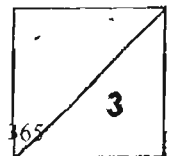

35. An experiment was set up to find out how wind affects the rate of evaporation of water. The experiment was set up as shown below.

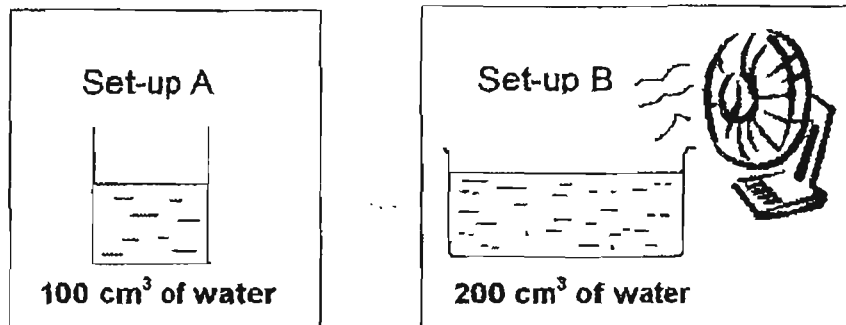

(a) Give 2 reasons why this experiment was not a fair one.

(i) _____ [1]

(ii) _____ [1]

(b) If the experiment was done correctly, what should be measured to find the result? [1]

(c) Beside using a fan, how else can you evaporate the water in Set-up B faster? [1]

36. The diagram below represents the respiratory system of a man.

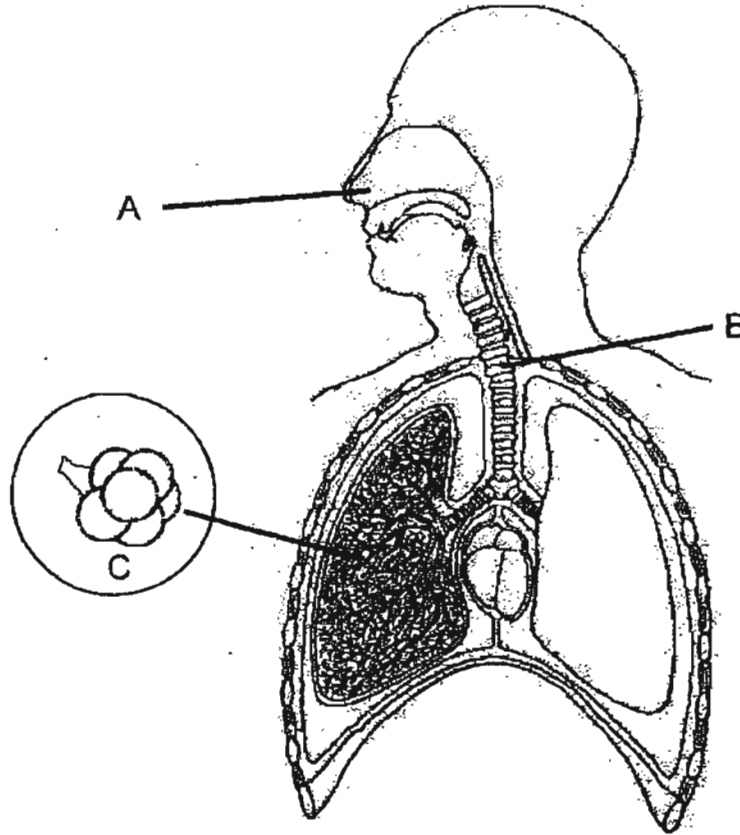

Name the different parts represented by the letters in the diagram above.

- A: _____ [1]
B: _____ [1]
C: _____ [1]

37. A plant and a beaker of limewater are sealed up in a wooden box. The wooden box is left under the sun for one day.

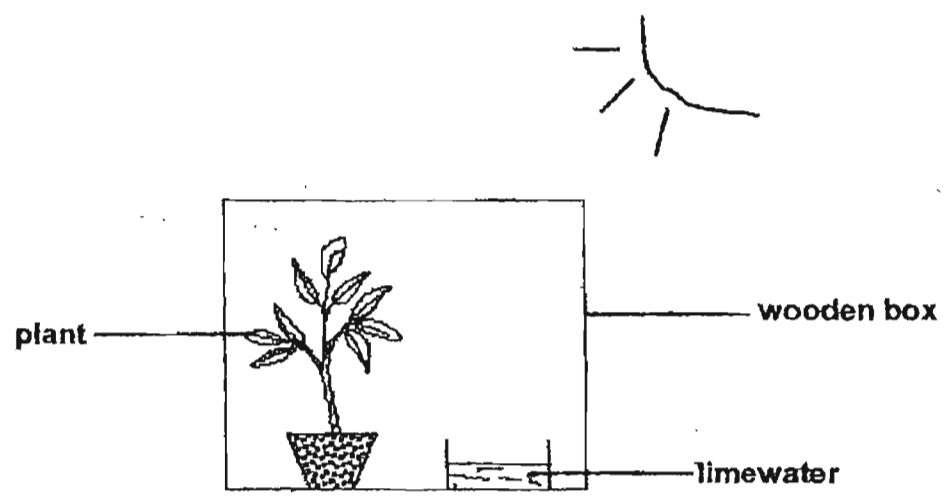

(a) What will happen to the limewater? [1]

(b) What process has taken place to cause the change in the limewater? [1]

(c) Complete the table below to show the exchange of gases during this process. [2]

Gas taken in	
Gas given out	

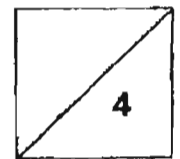

38. Kenny put a white flower in a beaker of red-coloured water as shown below.

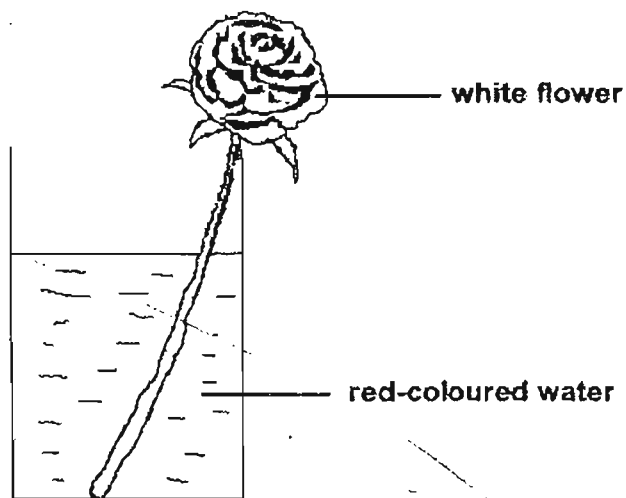

(a) What would happen to the white flower after 1 day? [1]

(b) What does this experiment show? [1]

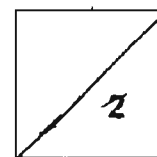

39. The diagram below shows the human circulatory system.

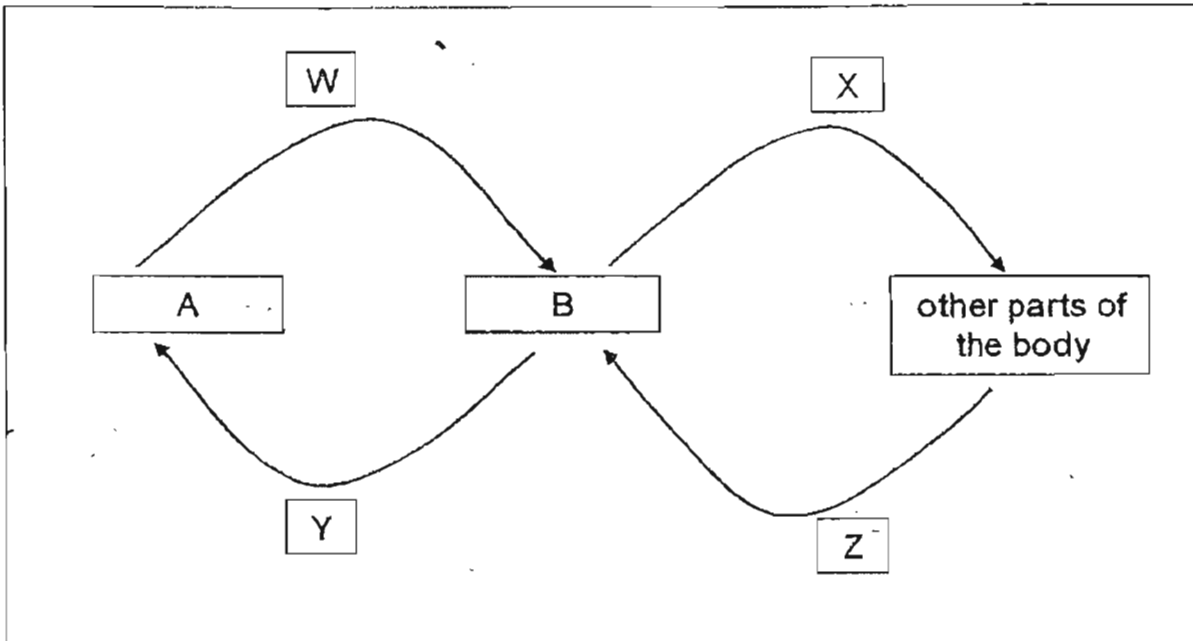

Arrows W, X, Y and Z represent the movement of blood. Boxes A and B each represent a different organ.

(a) What is organ B? _____ [1]

(b) What is the function of organ B? [1]

(c) Which arrow(s) represent(s) the movement of blood rich in carbon dioxide? [1]

40. Mary placed a metal spoon on an ice cube as shown in the diagram below.

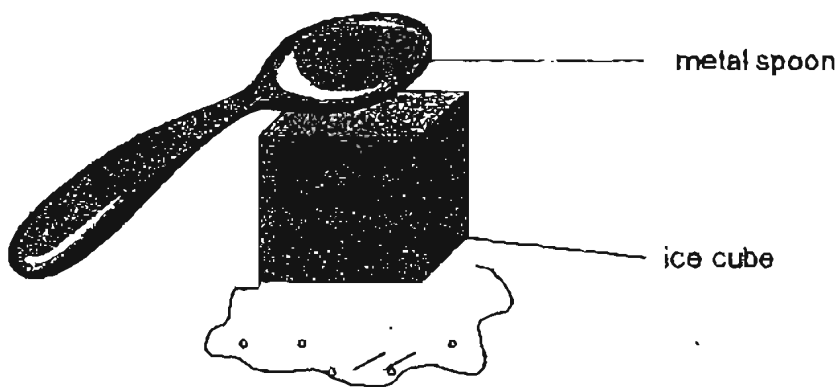

After a while, she observed that there were some changes to the spoon and the ice cube.

(a) What did she observe when she touched the spoon? [1]

(b) Explain why this happened. [1]

(c) What change of state did the ice go through? [1]

42. Two different metal rods (Rod A and Rod B) of the same length and diameter are joined together as shown below. Two thumbtacks A and B are stuck to Rod A and Rod B using wax.

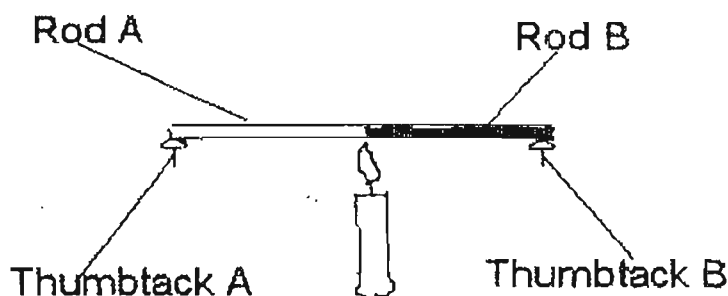

When the candle was lit, Thumbtack B dropped off first followed by Thumbtack A.

- (a) Explain why the wax melted and the thumbtacks dropped off. [1]

- (b) Explain why Thumbtack B dropped off first. [1]

43. A torch is shone at a wooden block to produce a shadow on the screen.

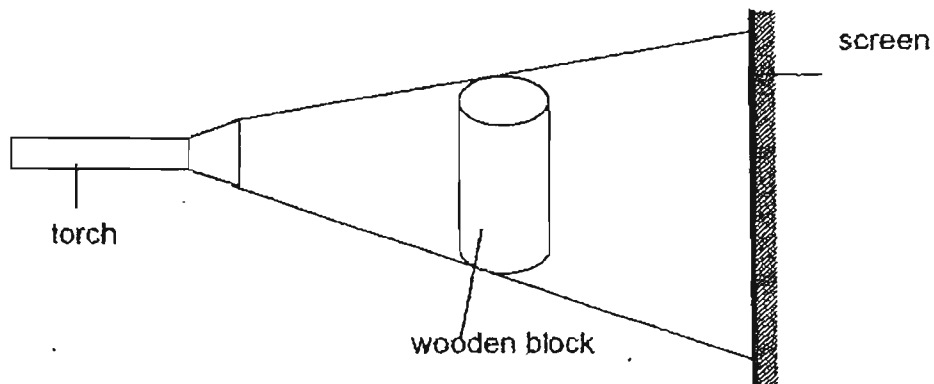

Write down two ways in which a bigger shadow of the wooden block can be formed.

(a) _____ [1]

(b) _____ [1]

44. Classify the following materials under the correct headings. [2]

wool iron copper porcelain

	Good conductors of heat	Poor conductors of heat
i)		
ii)		
iii)		

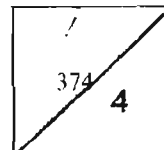

45. The diagram below shows a solid wooden cone.

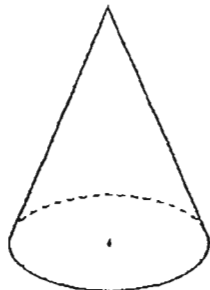

A strong ray of light is shone at the cone.
In the boxes below, draw two different shadows that can be cast
by the cone. [2]

--	--

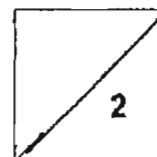

End-of-Paper
Please check your work carefully.



ANSWER SHEET

AI TONG PRIMARY SCHOOL - PRIMARY 4 SCIENCE 2007
SEMESTRAL ASSESSMENT (2)

1. 4 31) a) C b) D c) E
2. 3
3. 4 32) a) It is the ball and socket joint.
4. 2 b) Our shoulder.
- 5.
6. 1 33) a) Sawdust prevents the surrounding
7. 3 heat from travelling through the ice.
8. 1 b) Styrofoam, cloth, wool
9. 3
10. 1 34) a) Solid to liquid.
11. 1 b) i) boiling ii) evaporation
12. 4 c) More water/ice was added into the
13. 2 beaker.
14. 3
15. 1 35) a) i) Set up A and set up B have
16. 1 different containers.
17. 4 ii) Set up A and set up B have
18. 4 different volume of water.
19. 3 b) The water level of the water
20. 1 should be measured to find the
21. 1 result.
22. 3 c) Put the set up B of water under
23. 1 the sun.
24. 3
25. 4 36) A: nose B: windpipe C: air sacs
26. 3
27. 1 37) a) The lime water will turn chalky.
28. 3 b) The process is respiration.
29. 3 c) Oxygen
30. 1 carbon dioxide

38) a) The white flower will turn red after 1 day.
b) The red coloured water traveled through the xylem tubes in the stem to the flower.

39) a) the heart.
b) Organ B help to pump blood to other parts of the body.
c) Arrows P and Q.

40) a) the spoon will be cold.
b) this is because the spoon had loses heat to the ice cube.
c) From solid to liquid.

41) 1) pour the hot water into the tin.
2) immerse the outer metal cup into it.
3) The outer metal cup will expand.
4) fill the inner metal cup with ice and it will contract.
5) slowly separate the two cups.

42) a) the heat from the candle traveled along the rod to reach wax at the thumbtack and the wax melted.
b) Rod B is a better conductor of heat than rod A.

43) a) Move the torch nearer to the wooden block.
b) Move the screen further from the wooden block.

44) i) iron, wood
ii) copper, porcelain

45) ▲ ●