



MARIS STELLA HIGH SCHOOL (PRIMARY)

MID-YEAR EXAMINATION

SCIENCE

12 MAY 2022

BOOKLET A

NAME: \_\_\_\_\_ (      )

CLASS: Primary 4 (      )

24 questions

48 marks

Total Time for Booklets A & B: 1 h 30 min

DO NOT OPEN THIS BOOKLET UNTIL YOU ARE TOLD TO DO SO.

FOLLOW ALL INSTRUCTIONS CAREFULLY.

For each question from 1 to 24, four options are given. One of them is the correct answer. Make your choice (1, 2, 3 or 4). Shade the correct oval (1, 2, 3 or 4) on the Optical Answer Sheet (OAS). (48 marks)

1 Jasmine grouped some animals as shown in the table.

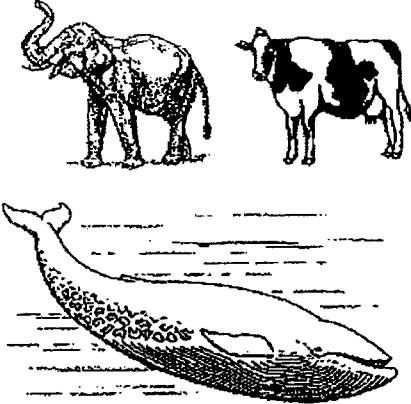
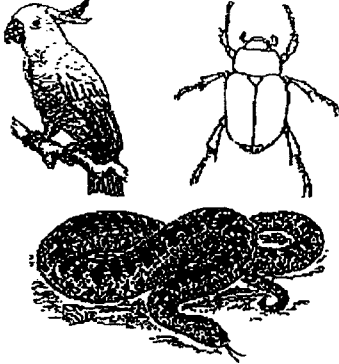
X	Y
	

Which of the following are suitable headings for X and Y?

	X	Y
(1)	does not have wings	has wings
(2)	can make their own food	cannot make their own food
(3)	reproduce by giving birth	reproduce by laying eggs
(4)	has hair as outer covering	has scales as outer covering

- 2 The diagram below shows two living things.



mushroom



fern

What is one similarity between the two living things?

- (1) They need light to survive.
  - (2) They reproduce by spores.
  - (3) They can make their own food.
  - (4) They can only be observed under the microscope.
- 3 Mark put four beans on some dry cotton wool in an uncovered beaker. He placed them on a table in his living room. The beans did not germinate after a few days.

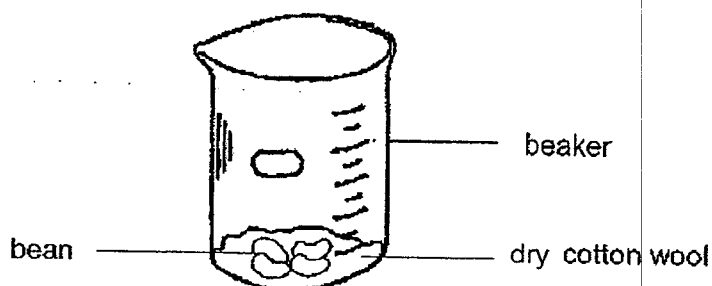

What must Mark do so that the beans will germinate?

- (1) Cover the beaker with a lid.
- (2) Place the beans in the refrigerator.
- (3) Add some water to the cotton wool.
- (4) Place the beans under direct sunlight.

- 4 Grace wanted to find out if moisture was needed for mould to grow. She placed one piece of bread each into two identical sealed plastic bags as shown.

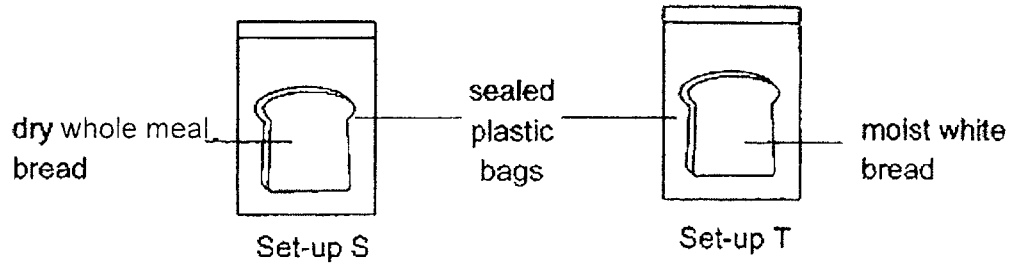

The table below shows the variables in Grace's experiment.

Variable	Set-up S	Set-up T
type of bread	wholemeal	white
amount of water poured on bread (cm <sup>3</sup> )	0	5
location of set-up	dark cupboard	dark cupboard

Why was the experiment **not** a fair one?

- (1) The type of bread used was different.
  - (2) The type of plastic bag used was the same.
  - (3) Water was not added to the bread in Set-up S.
  - (4) Both set-ups were placed in the same location.
- 5 Which of the following is a living thing?

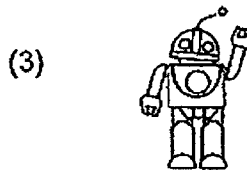
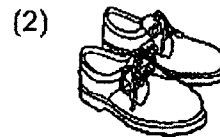
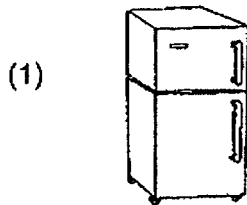

6 Study the classification chart below.

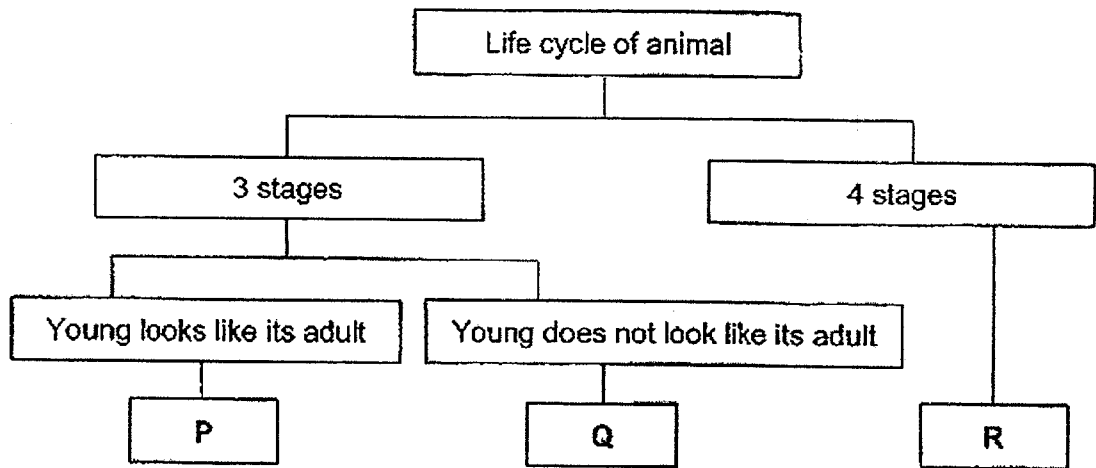

Which of the following represents P, Q and R?

	P	Q	R
(1)	frog	chicken	mosquito
(2)	butterfly	mosquito	cockroach
(3)	chicken	frog	butterfly
(4)	cockroach	butterfly	frog

7 Study the flowchart.

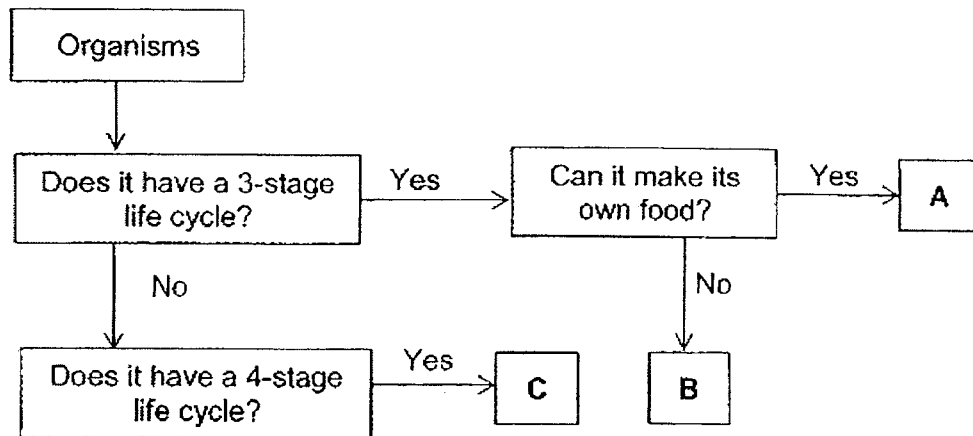

Which of the following best represents organisms A, B and C?

	A	B	C
(1)	grasshopper	rose plant	mosquito
(2)	beetle	chicken	rose plant
(3)	rose plant	beetle	chicken
(4)	rose plant	chicken	beetle

8 The diagram shows the life cycle of a flowering plant.

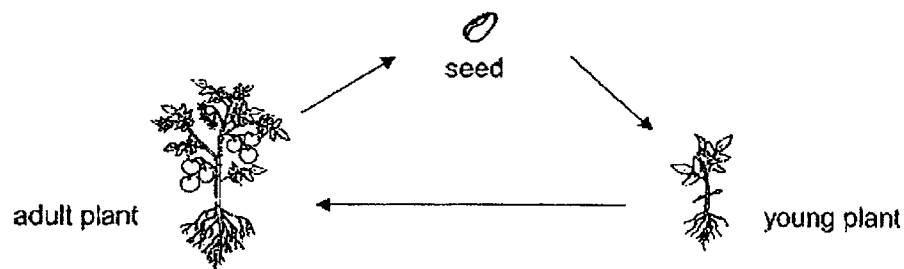

Which of the following statements about the life cycle of the flowering plant is wrong?

- (1) It has a 3-stage life cycle.
- (2) Flowers are found in the adult stage only.
- (3) Every stage of the plant needs water to survive.
- (4) Every stage of the plant can make its own food.

9 Study the table below.

	Material	Property
A	fabric	stiff
B	wood	strong
C	plastic	waterproof
D	metal	transparent

Which of the following correctly matches the materials to their properties?

- (1) A and B only
- (2) A and D only
- (3) B and C only
- (4) C and D only

10 Object X is flexible and does not break easily.

Which one of the following could object X be?

(1)



a frying pan

(2)



a hammer

(3)



a water hose

(4)



a glass

- 11 Mike conducted an experiment by placing 100 g weights on material X, one at a time, until the material broke.

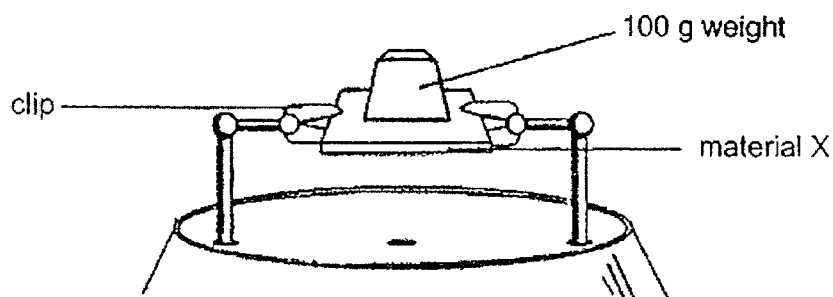

He repeated the experiment using three other different materials, W, Y and Z. He recorded the number of 100 g weights used to break each material in the table as shown.

Material	Number of 100 g weights
W	8
X	5
Y	2
Z	3

Which of the following statement(s) is/are true?

- A Material Y is the strongest.
- B Material X is stronger than Material Z.
- C Material X is more flexible than Material Y.
- D Material W is unable to hold a 100 g weight.

- (1) A only
- (2) B only
- (3) B and C only
- (4) C and D only



- 12 The table shows how some things are grouped.

A	B
air water orange juice	stone television whiteboard

Which of the following are suitable headings for A and B?

	A	B
(1)	no mass	has mass
(2)	no definite shape	has definite shape
(3)	no definite volume	has definite volume
(4)	can be compressed	cannot be compressed

- 13 The diagram below shows a container with substance X. The container was placed in different positions as shown.

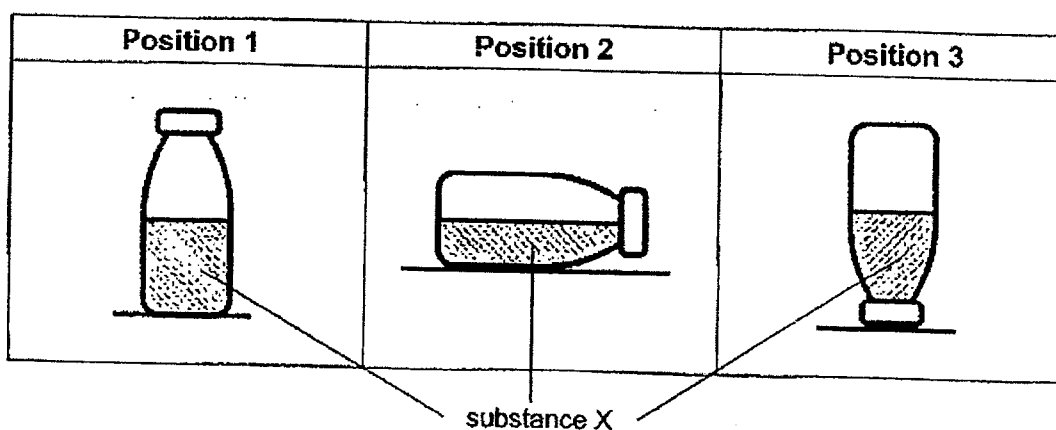

Based on the diagram, what can you conclude about substance X?

- (1) It is a solid.
- (2) It is a liquid.
- (3) It is not a matter.
- (4) It can be compressed.

- 14 Four boys observed sand moving from the upper part to the lower part of an hourglass.

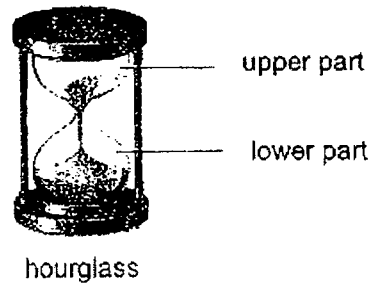

The four boys made the following statements about the sand they observed.

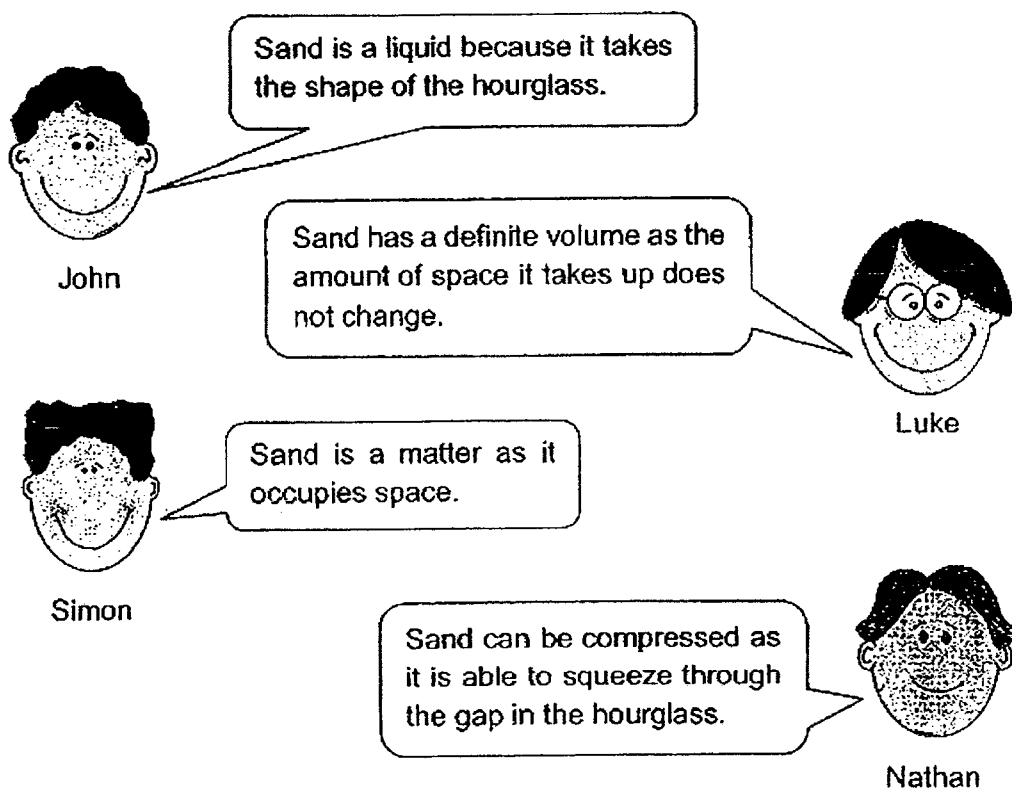

Whose statements are correct?

- (1) John and Luke only
- (2) Luke and Simon only
- (3) John and Nathan only
- (4) Simon and Nathan only

- 15 Gwen filled measuring cylinder A with marbles to the 50 cm<sup>3</sup> mark. She also filled measuring cylinder B with water to the 50 cm<sup>3</sup> mark.

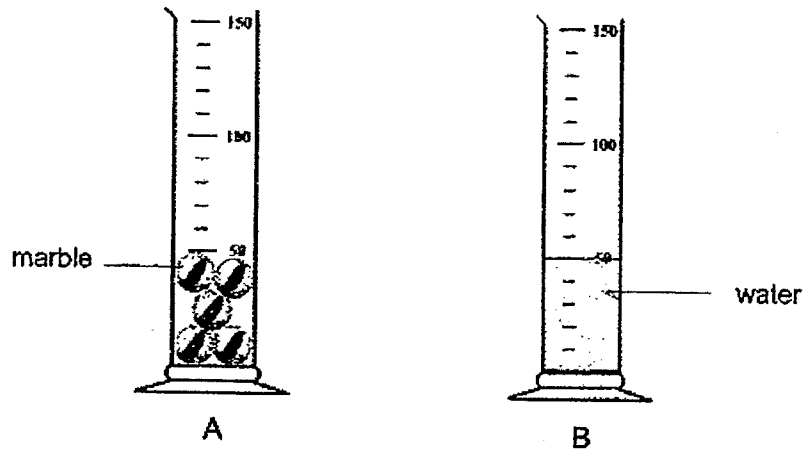

She then poured all the water from B into A.

Which of the following diagrams correctly shows the water level in A after she poured all the water from B into A?

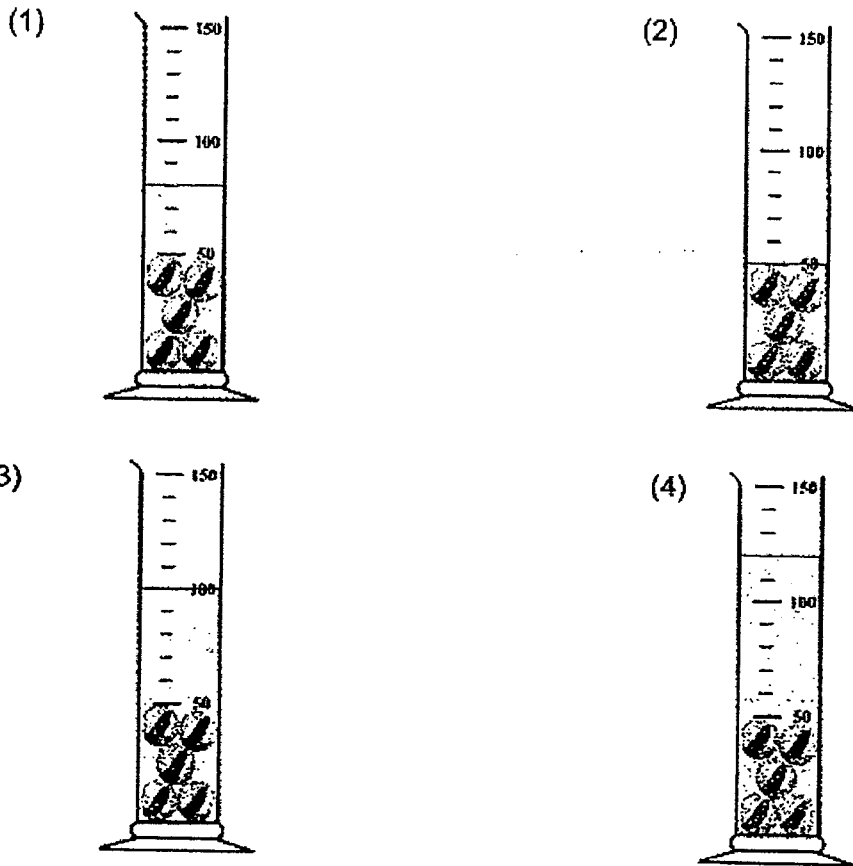

16 In which of the following will the two magnets push each other away?

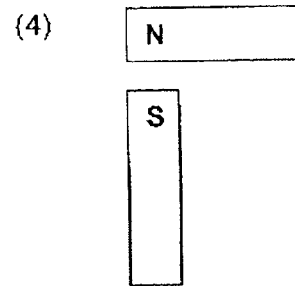
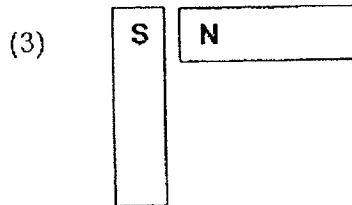
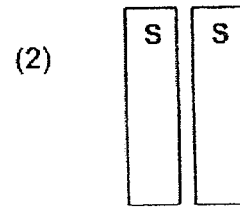
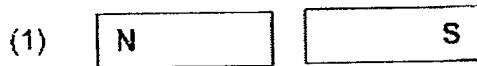

17 Michael found 3 unknown objects, A, B and C, and wanted to test if they were magnets. He placed a magnet near each of the objects. The table below shows his observations.

Object	Observation
A	A did not move.
B	B moved away from the magnet.
C	C moved towards the magnet.

Which of the following object(s) is/are definitely a magnet?

- (1) A only
- (2) B only
- (3) C only
- (4) B and C only

- 18 Susan hung magnets A, B, C and D on a rod and placed a tray of paper clips below the magnets. The diagram shows the number of paper clips each magnet attracted.

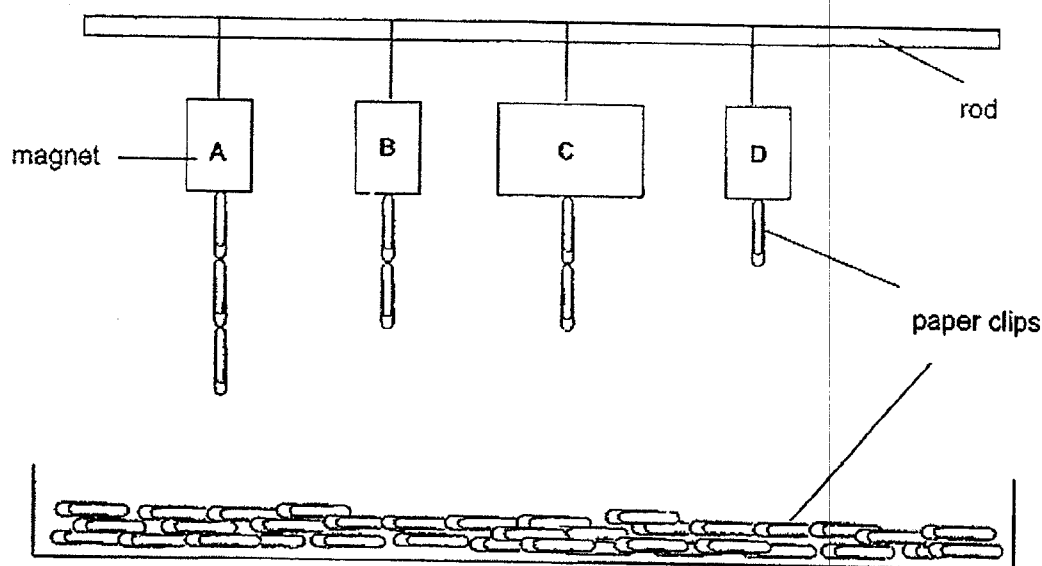

Based on the observation, which of the following is correct?

- (1) Magnet C is the weakest magnet.
- (2) Magnet D is the strongest magnet.
- (3) The magnetic strength of magnet A and B are different.
- (4) The size of the magnet affects the strength of the magnet.

- 19 Vincent prepared a set-up as shown below. He noticed that the paper clip was able to float in mid-air.

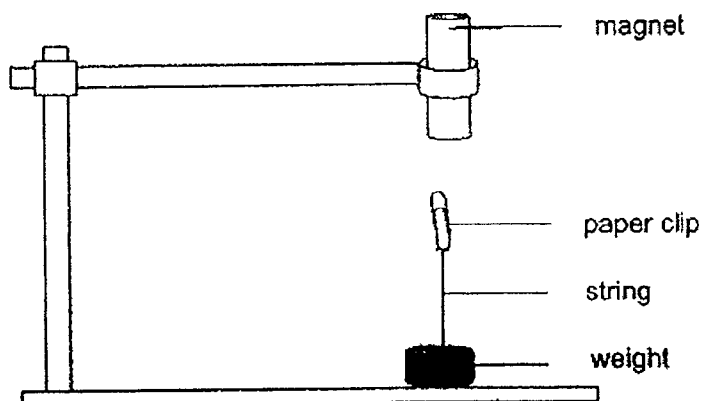

He then placed an iron sheet beneath the magnet and it moved towards the magnet. The paper clip fell and could not float in mid-air anymore.

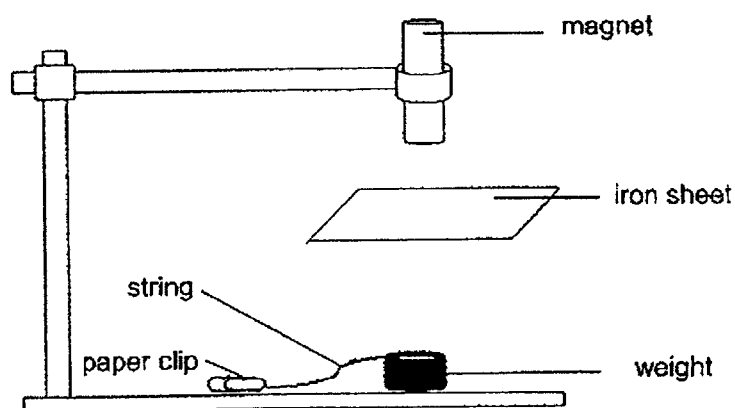

What can Vincent conclude from his observation?

- (1) The magnet repelled the paper clip.
- (2) The iron sheet has become a magnet.
- (3) The paper clip is not a magnetic material.
- (4) Magnetism cannot pass through the iron sheet.

- 20 Cindy placed an ice cube on a metal sheet and left it in her classroom. After 10 minutes, she observed that the ice had changed from solid to liquid.

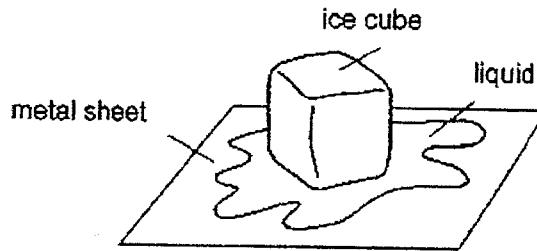

Which of the following correctly shows the heat transfer between the ice cube and the metal sheet?

	Ice cube	metal sheet
(1)	gain heat	lose heat
(2)	lose heat	gain heat
(3)	gain heat	gain heat
(4)	lose heat	lose heat

- 21 Lewis placed a bottle of cold milk in a mug of hot water as shown below.

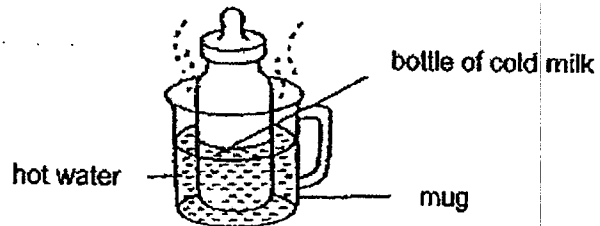

What would happen to the temperature of the milk and water in the mug after 10 minutes?

	Temperature of milk	Temperature of water
(1)	increase	decrease
(2)	decrease	decrease
(3)	decrease	increase
(4)	increase	increase

- 22 Two iron blocks, A and B, of different sizes are heated up at the same time with the same heat source. Both blocks are heated to a temperature of  $100^{\circ}\text{C}$ .

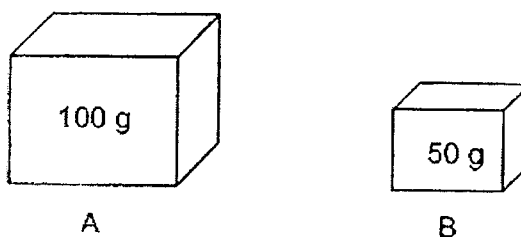

Which of the following statements is correct?

- (1) A has more heat energy than B.
  - (2) A has a higher temperature than B.
  - (3) Both A and B have the same amount of heat energy.
  - (4) Both A and B took the same amount of time to be heated to  $100^{\circ}\text{C}$ .
- 23 Nicholas wanted to find out the heat conductivity of rods W, X, Y and Z. He used the set-up as shown.

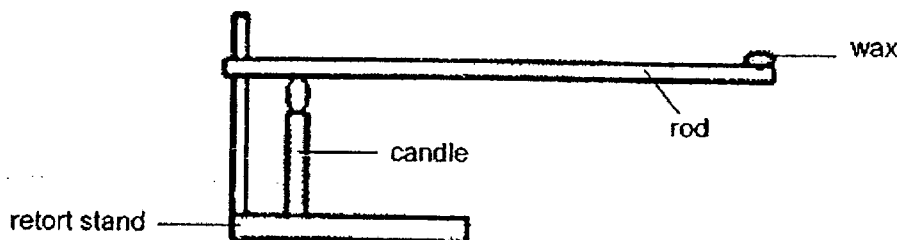

A candle was placed at one end of the rod while a piece of wax attached on the other end of the rod. He recorded the time taken for the wax to melt completely for each of the rods.

Rod	W	X	Y	Z
Time taken for wax to melt completely (min)	3	1	11	5

Based on the results, which rod is the best conductor of heat?

- (1) W
- (2) X
- (3) Y
- (4) Z



- 24 Joshua wanted to find out if the number of heat sources affects the time taken for water to boil.

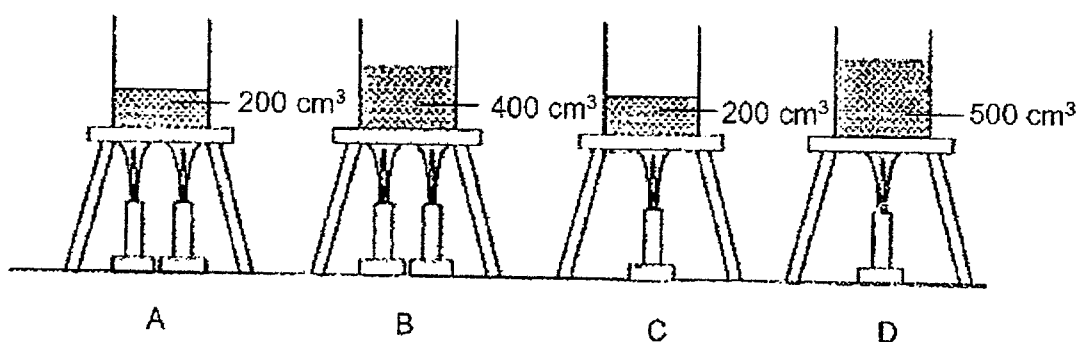

Which two set-ups should he use to conduct a fair experiment?

- (1) A and C
- (2) B and D
- (3) A and B
- (4) C and D

**End of Booklet A**





## MARIS STELLA HIGH SCHOOL (PRIMARY)

## MID-YEAR EXAMINATION

## SCIENCE

12 MAY 2022

## BOOKLET B

NAME: \_\_\_\_\_ ( )

CLASS: Primary 4 ( )

10 questions

32 marks

Total Time for Booklets A &amp; B: 1 h 30 min

DO NOT OPEN THIS BOOKLET UNTIL YOU ARE TOLD TO DO SO.

FOLLOW ALL INSTRUCTIONS CAREFULLY.

Booklet A: \_\_\_\_\_ / 48

Booklet B: \_\_\_\_\_ / 32

Grand Total: \_\_\_\_\_ / 80

Parent's Signature: \_\_\_\_\_

For questions 25 to 34, write your answers in this booklet. The number of marks available is shown in brackets [ ] at the end of each question or part question. (32 marks)

25 The pictures below show organisms A and B.



A



B

(a) Choose the correct words from the box to answer the question.

bacteria	flowering plant	fungi	non-flowering plant
----------	-----------------	-------	---------------------

Identify organisms A and B.

[2]

A : \_\_\_\_\_

B : \_\_\_\_\_

(b) Study Animal X shown below.

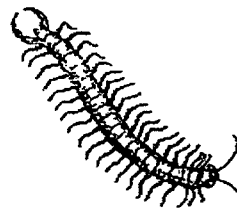

Animal X

Give two reasons why Animal X is not an insect.

[2]

Reason 1: \_\_\_\_\_

\_\_\_\_\_

Reason 2: \_\_\_\_\_

\_\_\_\_\_

- 26 Paul set up an experiment as shown and observed the lizard for two weeks.

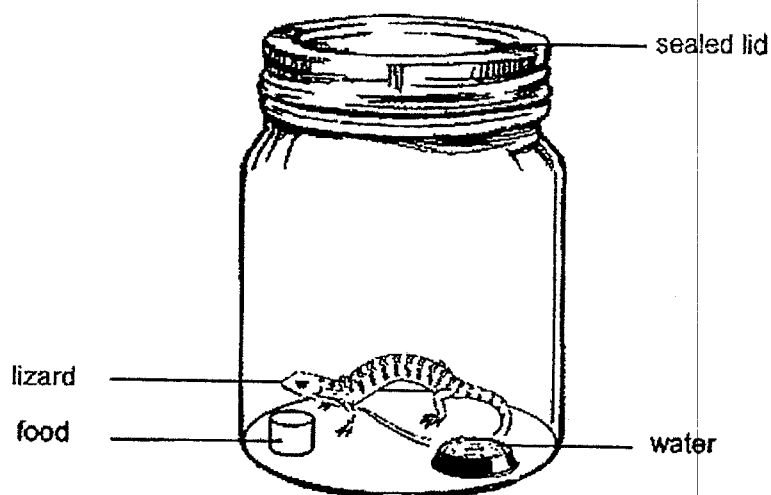

- (a) The lizard did not survive after two weeks. Give a reason why. [1]

---

---

- (b) What characteristic of living things does Paul's experiment show? [1]

---

---

- 27 The life cycle of a butterfly is shown below.

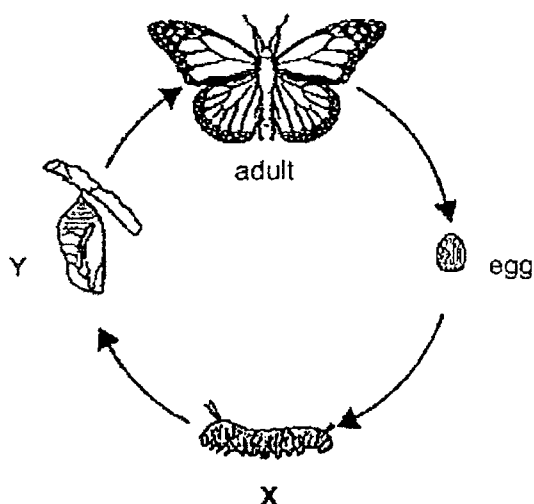

- (a) Identify stages X and Y. [2]

X: \_\_\_\_\_ Y: \_\_\_\_\_

- (b) The butterfly was given 100 g of food at the egg stage. No additional food was given at other stages. The table below shows the amount of food left at the end of each stage.

Stage	Amount of food left (g)
egg	100
X	30
Y	30
adult	10

- Explain why there was no change in the amount of food left at stage Y. [1]

---



---

28 Jolene prepared two set-ups to test the property of materials A and B. The diagram below shows the observations made.

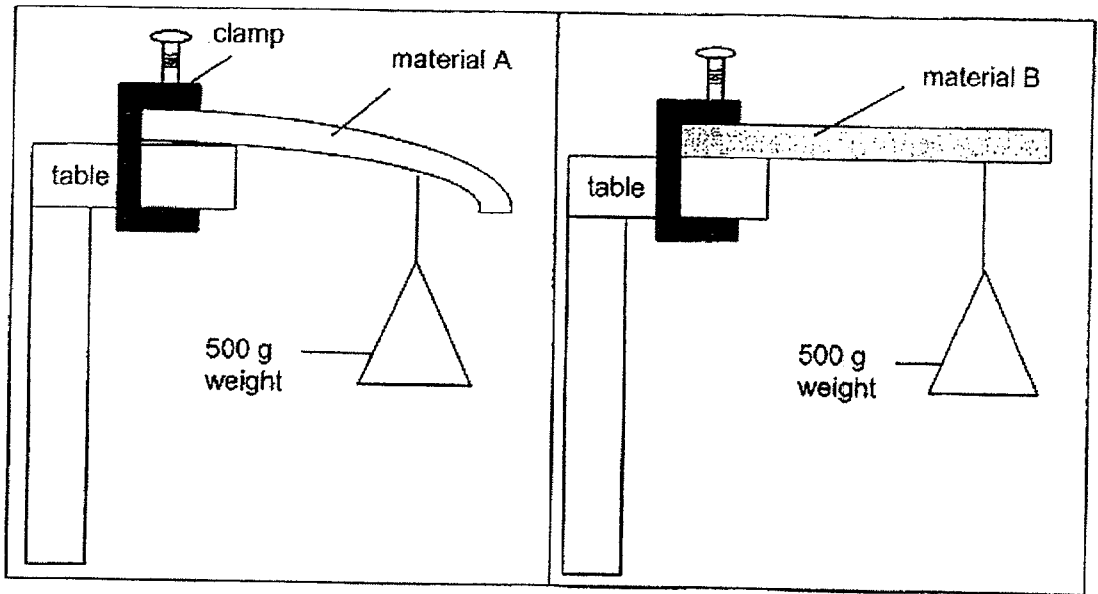

(a) What property of material was Jolene testing? [1]

(b) Based on the observations, which material, A or B, is more suitable to make rubber bands? Give a reason for your answer. [1]

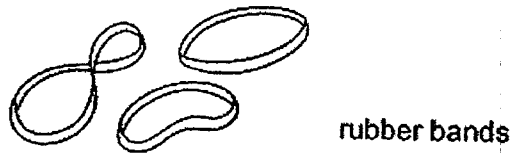



---

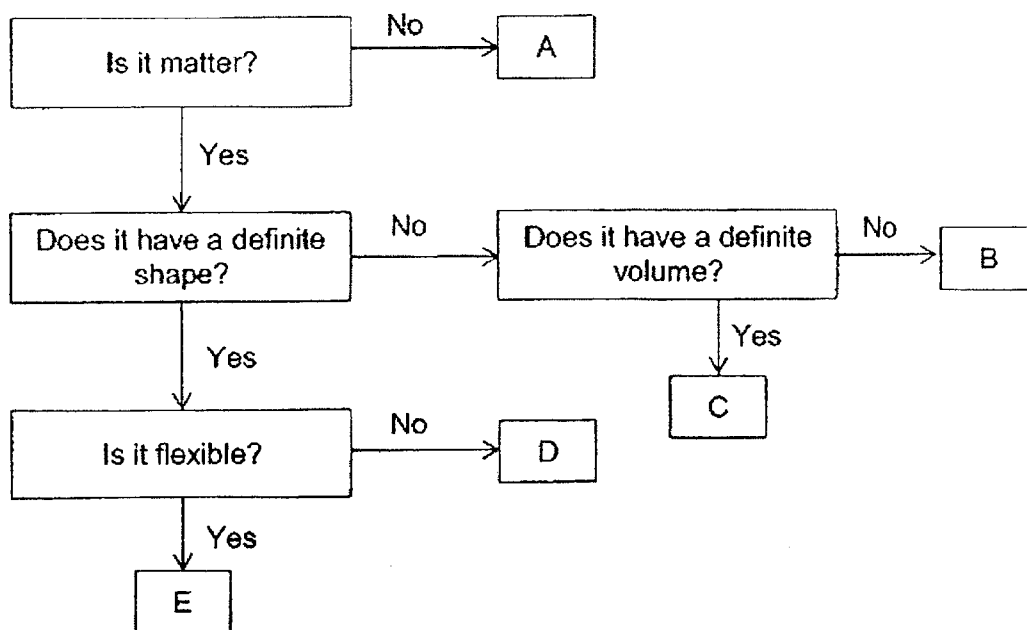

---

29 Study the flow chart below.



(a) Based on the flow chart, state two properties of object E. [1]

---

(b) Based on the flow chart, how is object B different from object D? [1]

---



---

(c) Which object, A, B, C, D or E, represents a pencil? [1]

---



- 30 Daniel filled a container with  $300\text{ cm}^3$  of water and  $100\text{ cm}^3$  of air. He then inserted a syringe that was completely filled with water into the stopper of the container.

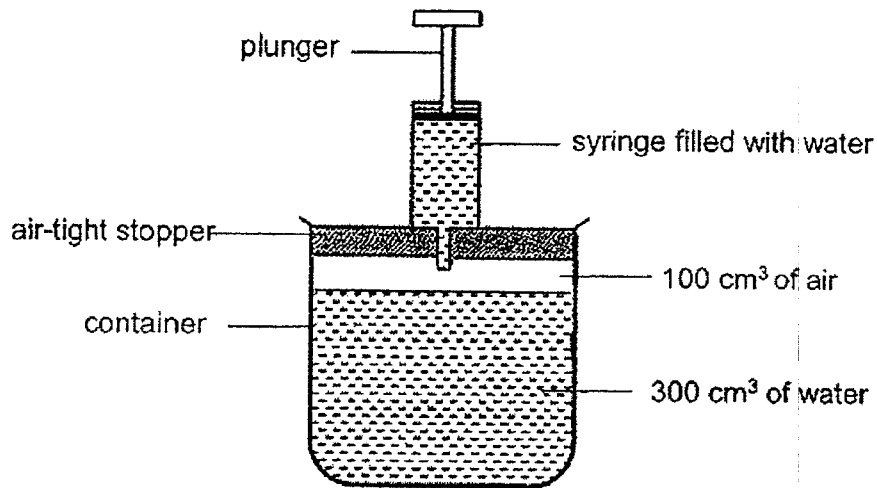

Daniel pushed the plunger down and all the water in the syringe entered into the container.

- (a) What is the amount of water in the syringe? Tick ( $\checkmark$ ) the correct box. [1]

$50\text{ cm}^3$

$100\text{ cm}^3$

$150\text{ cm}^3$

- (b) Name one property of air and water shown in this experiment. [2]

Property of air : \_\_\_\_\_

Property of water : \_\_\_\_\_

Daniel removed the syringe and stopper. He then added  $300\text{ cm}^3$  of pebbles into the container. The water in the container overflowed.

- (c) Give a reason why the water overflowed. [1]

---



---

31 Jonathan set up an experiment to find out how the number of batteries affects the strength of the electromagnet. His teacher told him that his experiment is not fair.

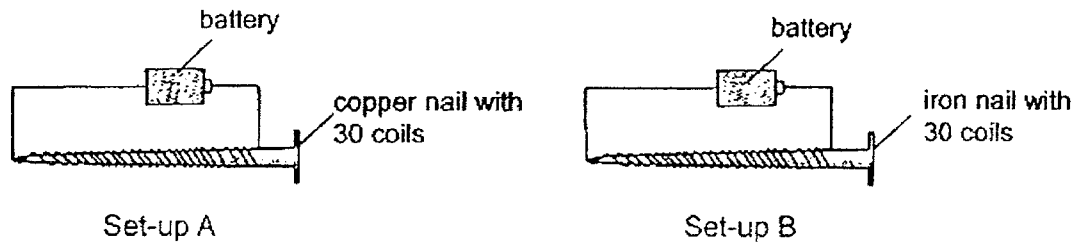

(a) What are two changes Jonathan should make to Set-up A so that his experiment is fair? [2]

1. \_\_\_\_\_  
\_\_\_\_\_
2. \_\_\_\_\_  
\_\_\_\_\_

(b) Based on the changes made in (a), compare the number of iron pins attracted to the electromagnet in Set-up A and Set-up B. [1]

\_\_\_\_\_  
\_\_\_\_\_

(c) How can Jonathan increase the strength of the electromagnet in Set-up B? [1]

\_\_\_\_\_

- 32 Elijah wanted to find out if the number of times a magnet was hit by a hammer would affect its strength. He recorded the maximum distance the magnet attracted the paper clip after hitting it with a hammer.

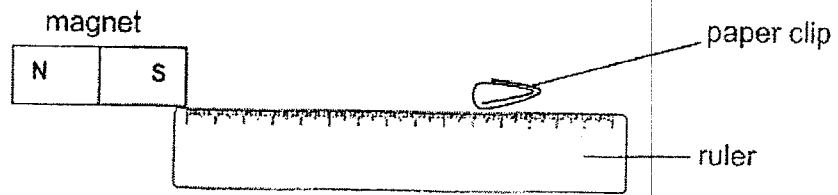

The table records Elijah's results.

Number of times the magnet was hit by a hammer	The maximum distance the paper clip was attracted to magnet (cm)
0	21
5	16
9	?
13	7
17	2

- (a) Elijah had missed out recording his result when the magnet was hit 9 times. What is a possible maximum distance the paper clip was attracted to the magnet? [1]

---

- (b) How was the strength of the magnet affected by the number of times it was hit? [1]

---



---

- (c) Explain why the magnet could not attract any paper clip after Elijah hit it 100 times. (Note: The magnet did not break after being hit) [1]

---



---

- 33 Gareth carried out an experiment to find out which material is most suitable to make a fireman's helmet. The helmet protects the user's head from fire.

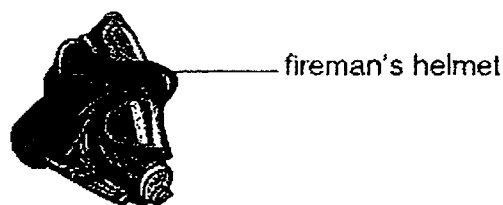

Using the set-up below, Gareth heated three materials A, B and C, for 5 minutes and measured the temperature of the materials. Materials A, B and C have the same size and thickness at the start of the experiment.

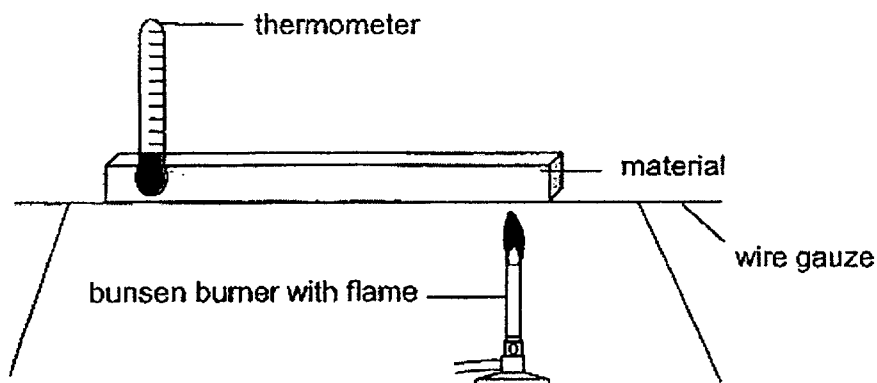

He recorded the temperature of the materials before and after heating them in the table shown.

Material	Temperature ( $^{\circ}\text{C}$ )	
	Before heating	After heating
A	30	80
B	30	31
C	30	65

- (a) Why did the temperature of materials increase after they were heated by the flame? [1]

---



---

- (b)** Based on the results in the table, arrange materials A, B and C, according to their heat conductivity. Fill in the boxes with letters **A**, **B** and **C**. [1]

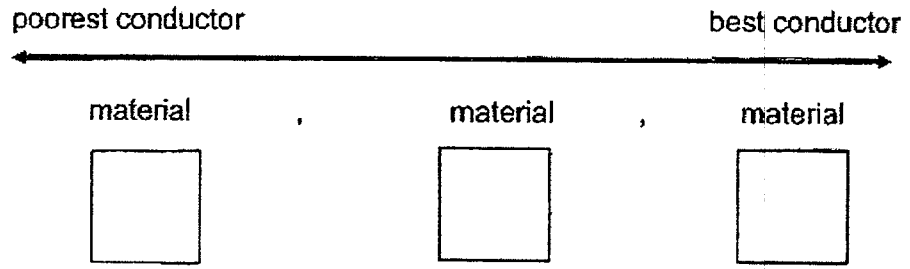

- (c)** From the results of the experiment, which material, A, B or C, should Gareth choose to make a fireman's helmet? Give a reason for your answer. [2]

---



---

- 34 Xavier heated a piece of wire. He measured the length of the wire before and after heating it.

Before heating

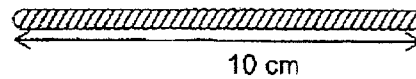

After heating

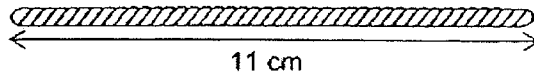

- (a) Explain why the length of the wire changed when heated. [1]

---



---

The picture below shows wires hung loosely from one post to another in the open.

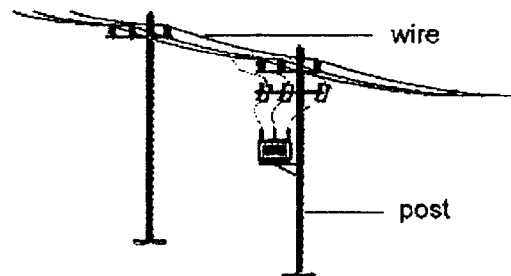

- (b) What will happen to the wires if they are hung tightly and the surrounding temperature is  $15^{\circ}\text{C}$ ? Explain why. [2]

---



---

End of paper

	3
--	---

**SCHOOL :** MARIS STELLA PRIMARY SCHOOL  
**LEVEL :** PRIMARY 4  
**SUBJECT :** SCIENCE  
**TERM :** 2022 SA1

**SECTION A**

Q1	Q2	Q3	Q4	Q5	Q6	Q7	Q8	Q9	Q10
3	2	3	1	4	3	4	4	3	3
Q11	Q12	Q13	Q14	Q15	Q16	Q17	Q18	Q19	Q20
2	2	2	2	1	2	2	3	4	1
Q21	Q22	Q23	Q24						
1	1	2	1						

**SECTION B**

Q25)	a) A: Flowering plant B: Fungi  b) R1: It does not have three pairs of legs R2: It does not have 3 body parts	
Q26)	a) It does not have receive enough oxygen b) Living things require air to survive	
Q27)	a) X: larva Y: Pupa b) There was no change as Y stage is pupa which does not move or eat	
Q28)	a) Flexibility b) Material A. It is more flexible than B	
Q29)	a) Definite shape and it is flexible b) B does not have definite shape but D does c) Object D	

Q30)	<p>a) 100cm<sup>3</sup></p> <p>b) Air: No definite shape Water: Takes up space</p> <p>c) The pebbles take up space causing the water to overflow</p>
Q31)	<p>a) 1: Add another battery to the set up 2: Change copper nail to iron nail</p> <p>b) Set-up A would have more iron pins as it has more batteries</p> <p>c) Add more to coils to set up B</p>
Q32)	<p>a) 12cm</p> <p>b) The more the magnet is hit, the more the strength of the magnet decreases</p> <p>c) The magnet has lost all of its magnetism.</p>
Q33)	<p>a) It gained heat from the fire</p> <p>b) B, C, A</p> <p>c) B. B is the poorest conductor of heat, preventing the firemen from being burnt</p>
Q34)	<p>a) The wire gained heat and expanded</p> <p>b) When the temperature decreases, the wire will lose heat and contract until it snaps.</p>