

PEI CHUN PUBLIC SCHOOL
CONTINUAL ASSESSMENT, 2017

MATHEMATICS
PRIMARY 5

PAPER 1
(BOOKLET A)

Additional materials: Optical Answer Sheet (OAS)

Total Time For Booklets A & B : 1 h

Name : _____ ()

Class : Primary 5 ____

Date : 15 August 2017

Maths Teacher: _____

INSTRUCTIONS TO CANDIDATES

DO NOT TURN OVER THIS PAGE UNTIL YOU ARE TOLD TO DO SO.

FOLLOW ALL INSTRUCTIONS CAREFULLY.

ANSWER ALL THE QUESTIONS.

SHADE YOUR ANSWERS IN THE OPTICAL ANSWER SHEET (OAS) PROVIDED.

YOU ARE NOT ALLOWED TO USE A CALCULATOR.

Questions 1 to 10 carry 1 mark each. Questions 11 to 15 carry 2 marks each.
For each question, four options are given. One of them is the correct answer.
Make your choice (1, 2, 3 or 4). Shade the correct oval (1, 2, 3 or 4) on the Optical Answer Sheet. (20 marks)

1. There are 184 087 people living in Toa Payoh. Express this number to the nearest thousand.

- (1) 180 000
- (2) 184 000
- (3) 184 100
- (4) 200 000

2. Which of the following has the greatest value?

- (1) 13.5
- (2) 13.54
- (3) 13.415
- (4) 13.504

3. What is the value of $16 + 40 \div 4 \times 2$?

- (1) 7
- (2) 21
- (3) 28
- (4) 36

4. How many eighths are there in $2\frac{1}{4}$?

- (1) 7
- (2) 9
- (3) 12
- (4) 18

5. Express $1\frac{3}{12}$ as a decimal.
- (1) 1.14
 - (2) 1.25
 - (3) 1.3
 - (4) 1.312
6. What is the value of 3.12×400 ?
- (1) 12.48
 - (2) 124.8
 - (3) 1248
 - (4) 12 480
7. Express 125 minutes in hours and minutes.
- (1) 1 h 5 min
 - (2) 1 h 25 min
 - (3) 2 h 5 min
 - (4) 2 h 25 min
8. What is the missing number in the box below?
- : 30 = 35 : 50
- (1) 7
 - (2) 10
 - (3) 15
 - (4) 21

9. Jack just turned 135° anti-clockwise. He is now facing west.

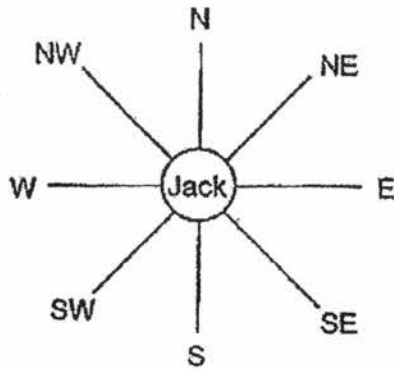

Where was Jack facing before he made the turn?

- (1) N
 - (2) NE
 - (3) S
 - (4) SE
10. The figure below is made up of 10 identical squares.



What percentage of the figure is shaded?

- (1) 30 %
- (2) 37.5 %
- (3) 50 %
- (4) 70 %

11. There are 720 pupils in a school. $\frac{5}{8}$ of the pupils are boys. How many more boys than girls are there in the school?

- (1) 90
- (2) 180
- (3) 270
- (4) 450

12. The perimeter of a rectangle is 34 cm. The length of the rectangle is 10 cm. What is the breadth of the rectangle?

- (1) 7 cm
- (2) 12 cm
- (3) 14 cm
- (4) 24 cm

13. The bar graph below shows the number of fruit trees in an orchard. The bar that shows the number of mango trees has not been drawn.

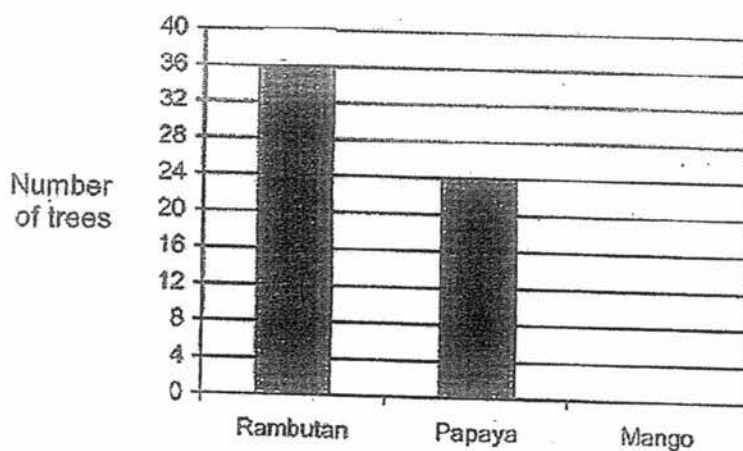

$\frac{2}{5}$ of the total number of trees are mango trees. How many mango trees are there?

- (1) 16
- (2) 24
- (3) 36
- (4) 40

14. Pamela baked some cookies. She gave Ron half of the cookies plus 3 cookies. She gave Sean half of the remaining cookies plus 4 cookies. After that, she had 7 cookies left. How many cookies did Pamela bake?

- (1) 22
- (2) 25
- (3) 44
- (4) 50

15. A buffet lunch at a restaurant costs \$11.40 per person. During a promotion, 1 customer dines for free with every 3 paying customers. What will be the total cost for a group of 10 people to have lunch there?

- (1) \$68.40
- (2) \$79.80
- (3) \$91.20
- (4) \$114

B

PEI CHUN PUBLIC SCHOOL
CONTINUAL ASSESSMENT, 2017

MATHEMATICS
PRIMARY 5

PAPER 1
(BOOKLET B)

Total Time For Booklets A & B : 1 h

Name : _____ ()

Class : Primary 5 ____

Date : 15 August 2017

Maths Teacher: _____

INSTRUCTIONS TO CANDIDATES

DO NOT TURN OVER THIS PAGE UNTIL YOU ARE TOLD TO DO SO.

FOLLOW ALL INSTRUCTIONS CAREFULLY.

ANSWER ALL QUESTIONS.

SHOW YOUR WORKING CLEARLY AS MARKS ARE AWARDED FOR CORRECT WORKING.

YOU ARE NOT ALLOWED TO USE A CALCULATOR.

Questions 16 to 20 carry 1 mark each. Write your answers in the spaces provided.
For questions which require units, give your answers in the units stated. (5 marks)

Do not write
in this space

16. Write eight hundred and five thousand and twenty in figures.

Answer : _____

17. Find the value of $\frac{5}{6} - \frac{1}{8}$.

Answer : _____

18. Find the value of $\frac{2}{3} \times \frac{5}{8}$. Give your answer as a fraction in the simplest form.

Answer : _____

SCORE

19. Pei Wen watched a movie that started at 5.15 p.m. and ended at 7.30 p.m. How long was the movie? Give your answer in hours and minutes.

Do not write
in this space

Answer : _____ h _____ min

20. The solid below is made up of unit cubes. How many units cubes are used to build the solid?

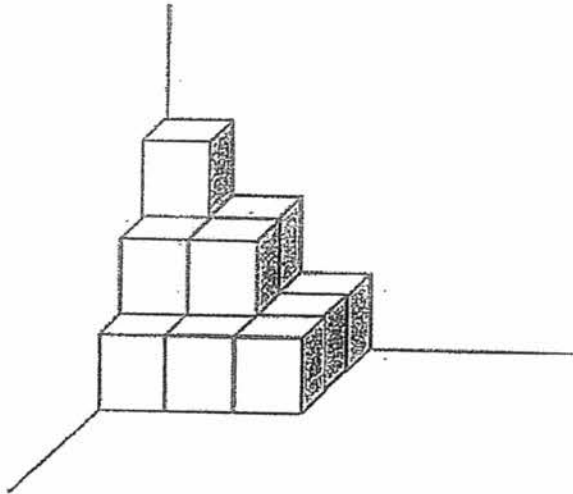

Answer : _____

SCORE

Questions 21 to 30 carry 2 marks each. Show your working clearly and write your answers in the spaces provided. For questions which require units, give your answers in the units stated. (20 marks)

Do not write
in this space

21. Using the digits 5, 4, 0 and 3,
(a) form the smallest 3-digit number.
(b) form a number closest to 4000.

Answer : (a) _____

(b) _____

- 22 (a) Compare and order the following fractions in decreasing order.

(b) Find the value of $3\frac{1}{2} - 1\frac{3}{5}$

Answer : (a) _____

(b) _____

SCORE

23. Find the equivalent measures for each of the following.

(a) $4 \text{ kg } 38 \text{ g} = \underline{\hspace{2cm}} \text{ kg}$

(b) $2004 \text{ m} = \underline{\hspace{1cm}} \text{ km } \underline{\hspace{1cm}} \text{ m}$

Do not write
in this space

Answer : (a) $\underline{\hspace{2cm}}$ kg

(b) $\underline{\hspace{1cm}}$ km $\underline{\hspace{1cm}}$ m

24. The mass of 7 identical chairs is 18 kg. What is the mass of a chair?
Round your answer to 1 decimal place.

Answer : $\underline{\hspace{2cm}}$ kg

25. What is the area of triangle ABC?

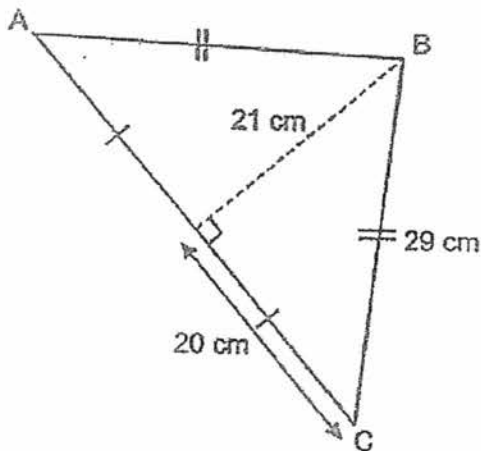

Answer : $\underline{\hspace{2cm}}$ cm²

SCORE

26. (a) Draw an angle XYZ which is equal to 52° .
The line XY has been drawn for you.

Do not write
in this space



- (b) Draw a line AB that is perpendicular to line CAD in the grid below.

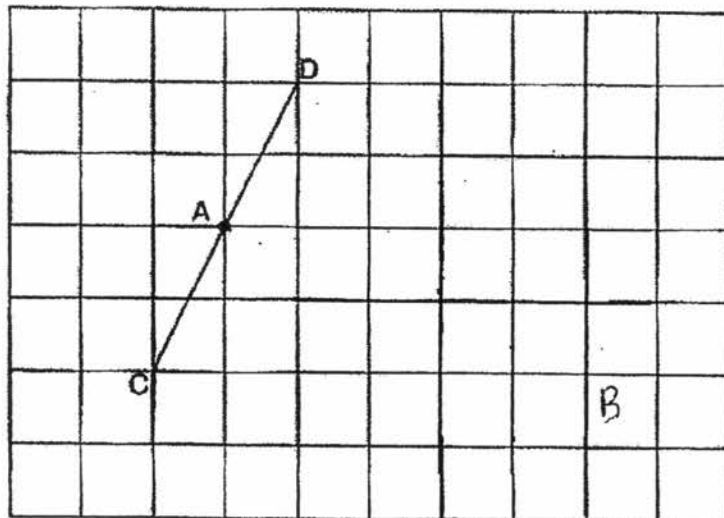

SCORE

27. One side of a cuboid has been drawn in the isometric grid below. Complete the drawing of the cuboid measuring 6 units by 2 units by 2 units.

Do not write
in this space

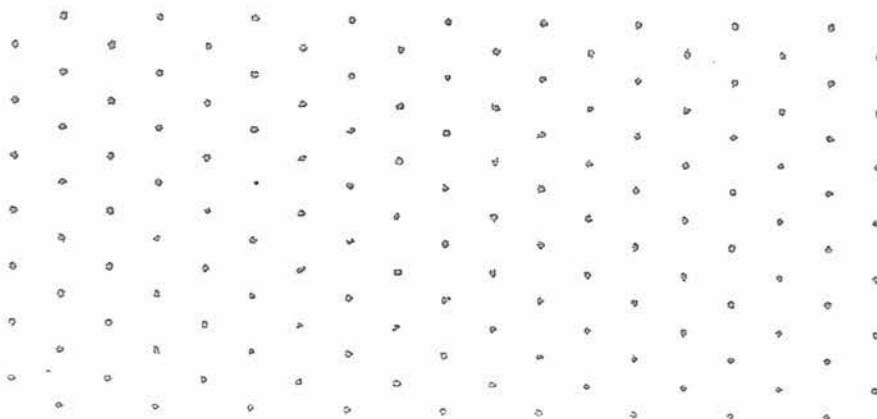

28. The postal rates of sending letters to two countries are shown below.

| Mass Step | Malaysia | China |
|---------------------------------------|----------|-------|
| First 20 g | 75¢ | 90¢ |
| Every additional 10 g or part thereof | 20¢ | 45¢ |

Mrs Wong posted a letter weighing 15 g to Malaysia and a letter weighing 29 g to China. How much postage did she pay altogether?

Answer : \$ _____

SCORE

29. There are some apples, oranges and pears at a fruit stall. The ratio of the number of apples to the number of oranges to the number of pears at the fruit stall is 7 : 18 : 11.

Do not write
in this space

Each statement below is either true, false or not possible to tell from the information given. For each statement, put a tick (✓) in the correct column.

| Statement | True | False | Not possible to tell |
|---|------|-------|----------------------|
| There are 18 oranges and 11 pears at the fruit stall. | | | |
| There are as many oranges as apples and pears altogether. | | | |

30. A group of children read a total of 42 books in June. The table below shows the number of children who read 4 or 6 books. The rest of the children read 3 or 5 books.

| Number of books read in June | Number of children |
|------------------------------|--------------------|
| 3 | ? |
| 4 | 1 |
| 5 | ? |
| 6 | 2 |

The number of children who read 3 books is less than 4. How many children read 5 books?

Answer : _____

End of Paper

Set by: Mr Nai, Mr Teng, Mr Yee

SCORE

PEI CHUN PUBLIC SCHOOL
CONTINUAL ASSESSMENT, 2017

MATHEMATICS
PRIMARY 5

PAPER 2

Time: 1 h 30 min

Name : _____ ()

Class : Primary 5 ____

Date : 15 August 2017

Maths Teacher: _____

Parent's Signature: _____

| | |
|------------------------|------------|
| Paper 1 (Booklet A) | 20 |
| Paper 1 (Booklet B) | 25 |
| Paper 2 | 55 |
| TOTAL | 100 |

INSTRUCTIONS TO CANDIDATES

DO NOT TURN OVER THIS PAGE UNTIL YOU ARE TOLD TO DO SO.

FOLLOW ALL INSTRUCTIONS CAREFULLY.

ANSWER ALL QUESTIONS.

SHOW YOUR WORKING CLEARLY AS MARKS ARE AWARDED FOR CORRECT WORKING.

YOU ARE ALLOWED TO USE A CALCULATOR.

Questions 1 to 5 carry 2 marks each. Write your answers in the spaces provided. For questions which require units, give your answers in the units stated. (10 marks)

Do not write
in this space

-
1. There are 7 children for every 3 adults at a party. There are 130 people at the party. How many adults are there?

Answer : _____

-
2. Mr Tan had \$5000. He spent \$4350 to buy a computer. What percentage of his money did he spend on the computer?

Answer : _____ %

SCORE

3. (a) Complete the symmetric figure with AB as the line of symmetry.

Do not write
in this space

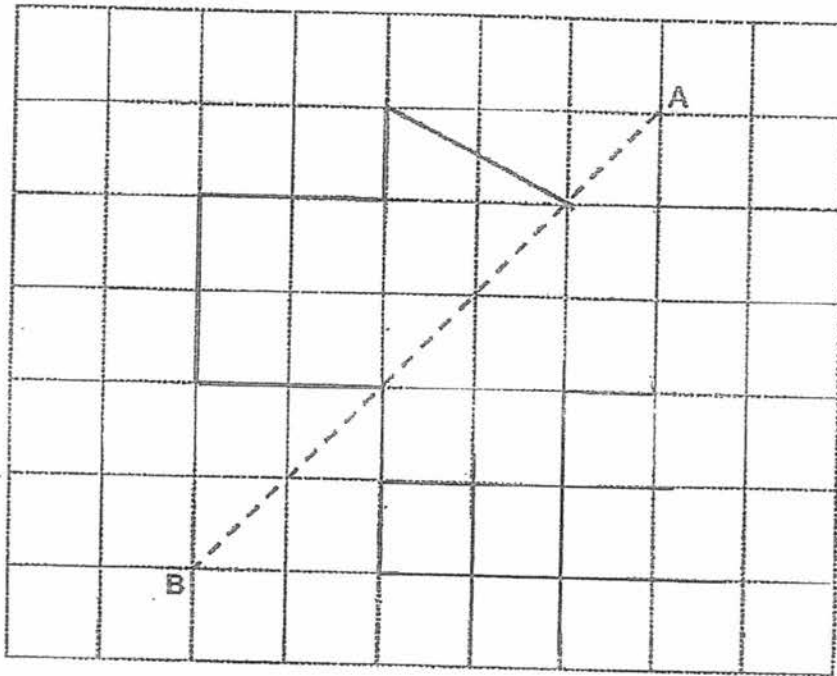

- (b) How many lines of symmetry does the figure below have?

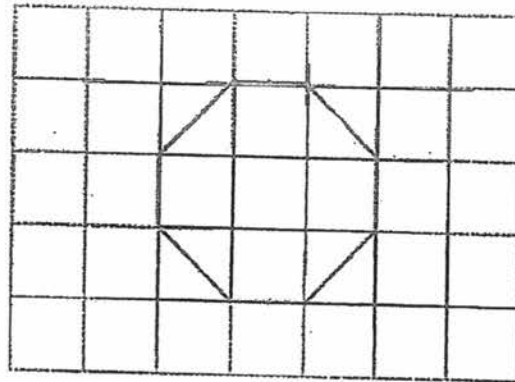

Answer : (b) _____

SCORE

4. Susan had $1\frac{1}{2}$ kg of flour at first. She used $\frac{3}{7}$ kg of flour to bake cakes and $\frac{1}{4}$ kg of flour to bake tarts. How much flour had she left?

Do not write
in this space

Answer : _____ kg

-
5. There was an equal number of red beads and yellow beads in a box at first. After Janice took out 77 red beads and 32 yellow beads, the ratio of the number of red beads to the number of yellow beads became 2 : 5. How many red beads were in the box in the end?

Answer : _____

SCORE

For questions 6 to 17, show your working clearly and write your answers in the spaces provided. The number of marks available is shown in brackets [] at the end of each question or part-question. (45 marks)

Do not write
in this space

6. Zen bought a watermelon, a honeydew and a durian. The watermelon and the honeydew cost \$7.80. The watermelon and the durian cost \$22.80. The durian cost 6 times as much as the honeydew. How much did Zen pay for the durian?

Answer : _____ [3]

7. The figure below shows a rectangular tank. $\frac{5}{6}$ of the tank is filled with water. Hafiz wants to fill the tank completely with water using a 550-ml bottle. How many full bottles of water does he need to fill the tank?

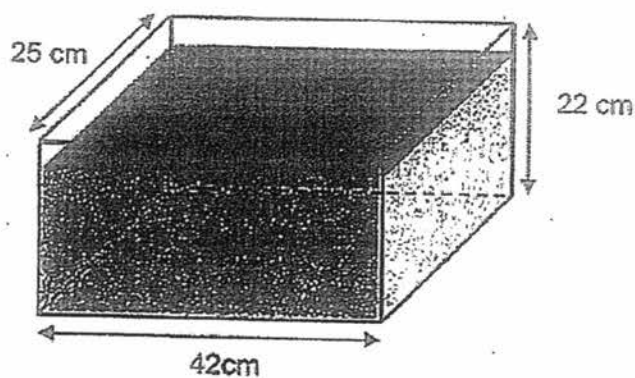

Answer : _____ [3]

SCORE

8. The ratio of Grace's age now to Peter's age now is 4 : 7. Grace is 28 years old now. What is the total age of Grace and Peter in 4 years' time?

Do not write
in this space

Answer : _____ [3]

9. Rachel bought some bags. The average cost of the bags was \$30. When she bought one more bag that cost \$90, the average cost of all the bags became \$35. How many bags did she buy at first?

Answer : _____ [3]

SCORE

10. $\frac{3}{4}$ of Sam's crayons is equal to $\frac{2}{5}$ of Janice's crayons. Sam has 133 fewer crayons than Janice. How many crayons does Janice have?

Do not write
in this space

Answer : _____ [3]

SCORE

11. A rectangular tank was partly filled with water. A tap was then turned on for half an hour to fill the tank completely. The line graph below shows the volume of water in the tank at regular intervals of time.

Do not write
in this space

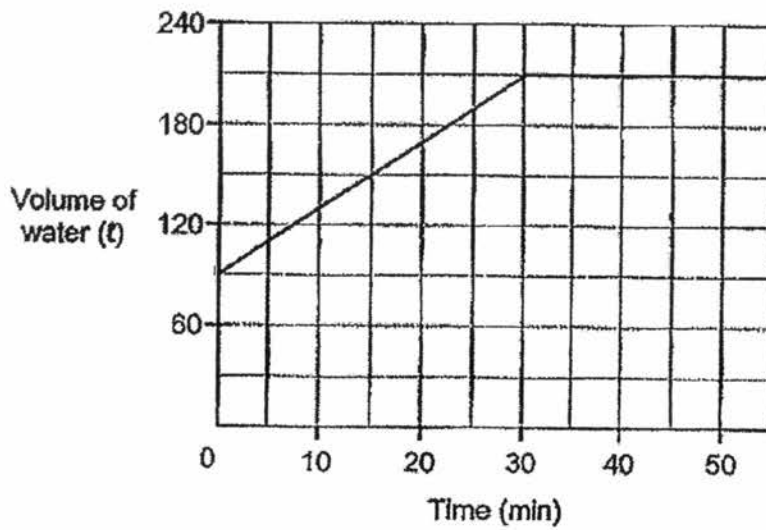

- (a) What was the capacity of the tank in litres?
- (b) What fraction of the tank was filled with water at first? Give your answer in the simplest form.
- (c) How many litres of water flowed out of the tap in one minute?

Answer : (a) _____ [1]

(b) _____ [1]

(c) _____ [2]

SCORE

12. A rectangular piece of paper is folded as shown below.

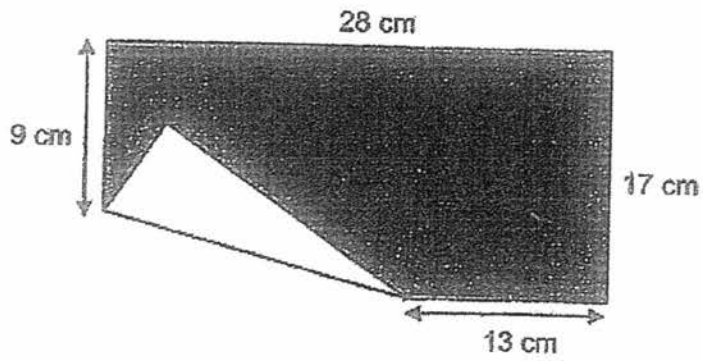

Find the shaded area.

Do not write
in this space

Answer : _____ [4]

SCORE

13. Shahiran and Kumar bought some identical books and files. Shahiran bought 5 books and 2 files. Kumar bought 2 books and 5 files. Shahiran paid \$4.50 more than Kumar.

- (a) How much more did a book cost than a file?
- (b) A file cost \$3.45. What was the cost of 5 books?

Do not write
in this space

Answer :(a) _____ [2]

(b) _____ [2]

SCORE

14. Steven baked some cookies to sell. He sold $\frac{2}{9}$ of his cookies in the morning and $\frac{5}{8}$ of the remaining cookies in the afternoon. He had 63 cookies left.

- (a) What fraction of the cookies had he left? Give your answer in the simplest form.
- (b) How many cookies did Steven bake?

Do not write
in this space

Answer : (a) _____ [2]

(b) _____ [2]

SCORE

15. Siti bought some stickers to be shared equally among a group of 66 pupils. 18 of them gave all their stickers to the rest of the pupils. As a result, the rest of the pupils received 3 more stickers each. How many stickers did Siti buy?

Do not write
in this space

Answer : _____ [4]

SCORE

16. The table below shows the fare rates of a taxi service.

| Distance travelled | Rate |
|--------------------------------|--------|
| 1st km or less | \$3 |
| Every 400 m thereafter or less | \$0.22 |
| Airport surcharge | \$5 |

- (a) A tourist boarded a taxi at the airport and headed for a hotel 8 km away. How much taxi fare did the tourist pay?
- (b) Jason boarded a taxi from his house to his office. He paid \$10.70. What was the greatest distance that the taxi could have travelled?

Do not write
in this space

Answer :(a) _____ [2]

(b) _____ [3]

SCORE

17. Sammy and Amy had some postcards each. If Sammy gave Amy 84 postcards, both would have an equal number of postcards. For every 9 postcards Sammy used, Amy would use 2 postcards. When Amy had finished using all her postcards, Sammy was left with 63 postcards. How many postcards did Sammy have at first?

Do not write
in this space

Answer : _____ [5]

End of Paper

SCORE

Year : 2017
Level : Primary 5
School : Pei Chun Public School
Subject : Mathematics
Term : CA2

Paper 1

| | | | | | | | | | |
|----|---|----|---|----|---|-----|---|-----|---|
| Q1 | 2 | Q4 | 4 | Q7 | 3 | Q10 | 1 | Q13 | 4 |
| Q2 | 2 | Q5 | 2 | Q8 | 4 | Q11 | 2 | Q14 | 4 |
| Q3 | 4 | Q6 | 3 | Q9 | 2 | Q12 | 1 | Q15 | 3 |

Q16) 805 020

Q17) $\frac{17}{24}$

Q18) $\frac{5}{12}$

Q19) 2 h 15 min

Q20) 14

Q21a) 304

Q21b) 4035

Q22a) $\frac{6}{7}, \frac{4}{6}, \frac{4}{7}$

Q22b) 1.9

Q23a) 4.038kg

Q23b) 2km 4m

Q24) 2.6kg

Q25) 420

Q26a)

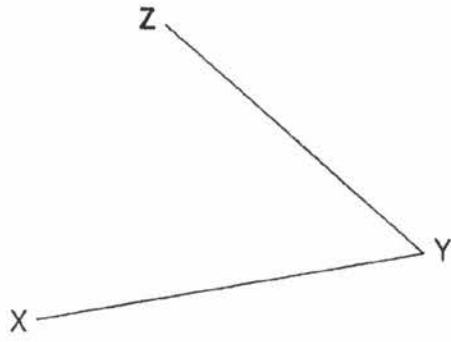

Q26b)

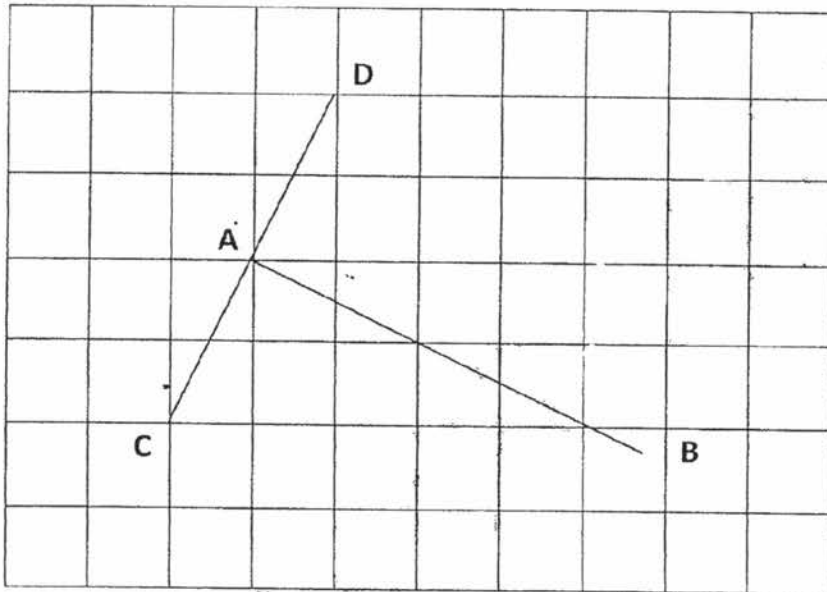

Q27)

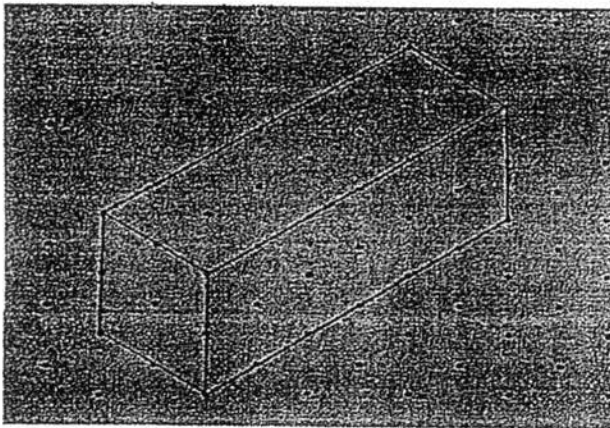

Q28) \$ 2.10

Q29)

| Statement | True | False | Not possible to tell |
|--|------|-------|----------------------|
| There are 18 oranges and 11 pears at the fruit stall. | | | ✓ |
| There are as many oranges as apples and pears altogether | ✓ | | |

Q30) 4

Paper 2

Q1) 1 group $\Rightarrow 7 + 3 = 10$

No. of groups $\rightarrow 130 \div 10 = 13$

No. Of adults $\rightarrow 13 \times 3 = 39$

Q2) 1% $\rightarrow 5000 - 100 = 50$

Percentage of money spent $\rightarrow 4350 \div 50 = 87\%$

Q3a)

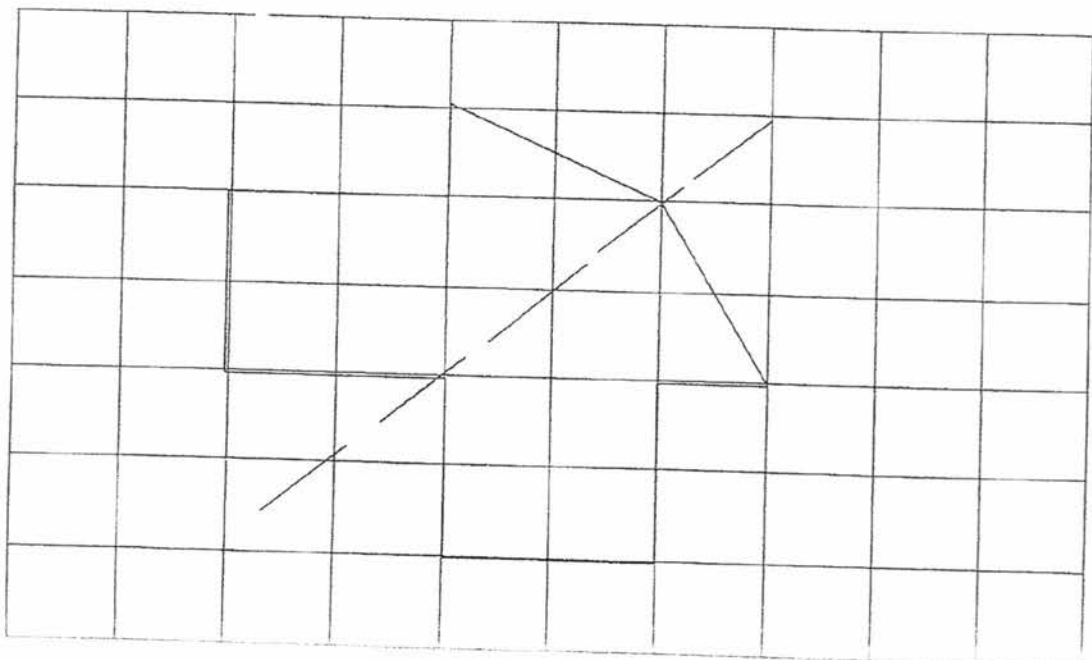

Q3b) 4

Q4) Flours to bake $\rightarrow 3/7 + 1/4 = 19/20$

Flour left $\rightarrow 3/2 - 19/28 = \underline{23/28\text{kg}}$

Q5) Red : Yellow

2 : 5

Difference in beads $\rightarrow 77 - 32 = 45$

3 units = 45

1 unit = $45 \div 3 = 15$

2 units = $15 \times 2 = \underline{30}$

Q6) 5 units = $\$21.80 - \$7.80 = \$15$

1 unit = $15 \div 5 = 3$

Durian $\rightarrow 3 \times 6 = \underline{\$18}$

Q7) Volume of tank $\rightarrow 42 \times 35 \times 22 = 23\ 100$

Volume of water $\rightarrow 1/6 \times 23\ 100 = 3\ 850$

Bottles $\rightarrow 3850 \div 550 = \underline{7}$

Q8) 4 years time :

Grace $\rightarrow 28 + 4 = 32$

Peter $\rightarrow 49 + 4 = 33$

Total $\rightarrow 32 + 53 = \underline{85}$

Q9) Difference $\rightarrow 35 - 30 = 5$

Bags bought at first $\rightarrow 55 \div 5 = \underline{11 \text{ bags}}$

Q10) 7 units = 133

1 unit = $133 \div 7 = 9$

Janice = $19 \times 15 = \underline{285}$

Q11a) 210 litres

Q11b) $\frac{3}{7}$ litres

Q11c) 30 mins $\rightarrow 120$ litres

1 min $\rightarrow 120 \div 3 = \underline{4}$

Q12) Rectangle $\rightarrow 28 \times 17 = 476$

Base $\rightarrow 17 - 9 = 8$

Height of triangle $\rightarrow \frac{1}{2} \times 8 \times 15 = 60$

Shaded area $\rightarrow 476 - 60 \times 2 = \underline{356}$

Q13a) 3 books - 3 files $\rightarrow \$4.50$

1 book - 1 files $\rightarrow \$4.50 \div 3 = \underline{\$1.50}$

Q13b) 1 book $\rightarrow 1.50 + 3.45 = 4.95$

5 books $\rightarrow 4.95 \times 5 = \underline{24.75}$

Q14a) $7/9 \times 3/8 = \underline{7/24}$

Q14b) $1/8$ of remaining cookies after selling $\rightarrow 63 \div 3 = 21$

Remaining cookies after selling $\rightarrow 21 \times 8 = 168$

$7/9$ of total cookies $\rightarrow 168$

$1/9$ of total cookies $\rightarrow 168 \div 7 = 24$

Total cookies $\rightarrow 24 \times 9 = \underline{216}$

Q15) Difference $\rightarrow 66 - 18 = 48$

Total No. of extra stickers 48 students get $\rightarrow 48 \times 3 = 144$

No. of stickers per person $\rightarrow 144 \div 18 = 8$

Stickers bought $\rightarrow 66 \times 8 = \underline{528}$

Q16a) 1st Km $\rightarrow \$3$

Sets of 400m $\rightarrow 7000 \div 400 = 18$ (nearest whole number)

Total paid $\rightarrow 3 \times 18 \times 0.22 - 5 = \underline{11.96}$

Q16b) After 1st Km $\rightarrow 10.70 - 3 = 7.70$

No. of 400m sets $\rightarrow 7.70 \div 0.22 = 35$

Greatest distance $\rightarrow 35 \times 0.4 + 1 = \underline{15\text{km}}$

Q17) Sammy has 1 unit + 84 + 84

Sammy \rightarrow 1 unit + 168

Amy \rightarrow 1 unit

1 unit = 2 part

Sammy \rightarrow 1unit + 168 = 63 + 4.5 unit

3.5 unit = 10.5

1 unit = 30

Sammy \rightarrow 30 + 168 = 198