



AI TONG SCHOOL
2023
END-OF-YEAR EXAMINATION
PRIMARY 5
MATHEMATICS
PAPER 1

DURATION : 1 h

DATE : 26 OCTOBER 2023

INSTRUCTIONS

Do not turn over this page until you are told to do so.

Follow all instructions carefully.

Answer all questions.

Shade your answers in the Optical Answer Sheet (OAS) provided.

The use of calculators is **NOT** allowed.

Name: _____ ()

Class: Primary 5 _____

Marks:

Parent's Signature :	_____
Date :	_____

Paper 1	45
----------------	-----------

- BLANK PAGE -

Paper 1 Booklet A

Questions 1 to 10 carry 1 mark each. Questions 11 to 15 carry 2 marks each.
For each question, four options are given. One of them is the correct answer.
Make your choice (1, 2, 3 or 4) and shade your answer on the Optical Answer Sheet.
(20 marks)

- 1 There were 312 089 visitors to a tourist attraction last year.
Express this number to the nearest thousand.

- (1) 300 000
- (2) 310 000
- (3) 312 000
- (4) 313 000

- 2 What is the value of $30 - (6 + 12) \div 3 \times 2$.

- (1) 8
- (2) 2
- (3) 18
- (4) 27

- 3 Which fraction is greater than $\frac{1}{2}$?

- (1) $\frac{4}{7}$
- (2) $\frac{3}{8}$
- (3) $\frac{4}{9}$
- (4) $\frac{5}{10}$

4 Which of the following is equal to $3\frac{5}{6}$?

(1) $\frac{15}{6}$

(2) $\frac{21}{6}$

(3) $\frac{23}{6}$

(4) $\frac{35}{6}$

5 What does the digit 9 in 7.698 stand for?

(1) 9 ones

(2) 9 tenths

(3) 9 hundredths

(4) 9 thousandths

6 Which of the following is likely to be the total mass of 6 one-dollar coins?

(1) 4000 g

(2) 400 g

(3) 40 g

(4) 4 g

7 What is the missing number in the \square ?

$$\square : 49 = 30 : 42$$

(1) 19

(2) 23

(3) 35

(4) 37

- 8 In the figure below, which two lines are parallel to each other?

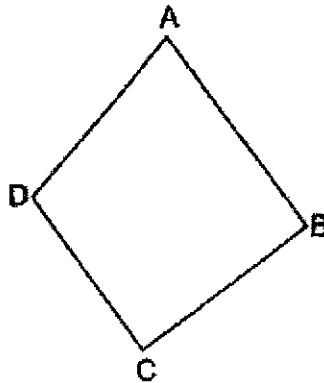

- (1) DA and CB
 (2) DA and DC
 (3) AB and CB
 (4) AB and DC
- 9 In the figure below, EF and GH are straight lines.
 Which one of the following is true?

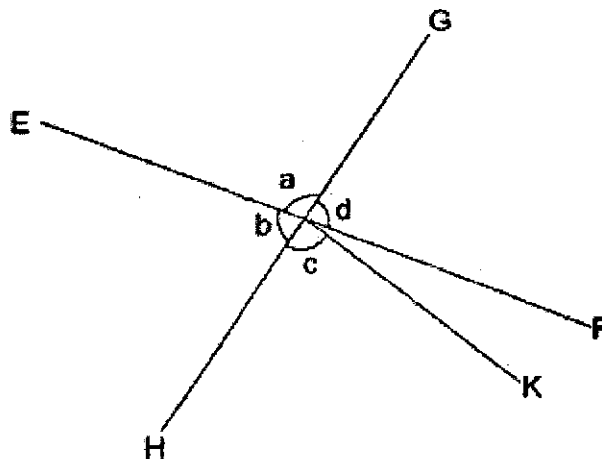

- (1) $\angle a + \angle c = 180^\circ$
 (2) $\angle b + \angle c = 180^\circ$
 (3) $\angle a = \angle c$
 (4) $\angle b = \angle d$

- 10 What is the area of triangle ABC?

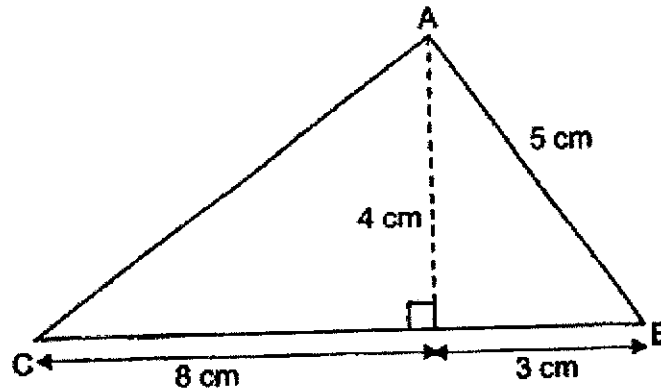

- (1) 22 cm^2
(2) 26 cm^2
(3) 44 cm^2
(4) 52 cm^2
- 11 There are apples, oranges and pears in a basket. The ratio of the number of apples to the number of oranges is 5 : 2. The ratio of the number of oranges to the number of pears is 1 : 4. What is the ratio of the number of apples to the total number of fruits in the basket?
- (1) 5 : 11
(2) 5 : 12
(3) 1 : 2
(4) 1 : 3

- 12 The average mass of Ali, Boon and Chai is 48 kg. Ali is 7 kg heavier than Boon. Ali is also 5 kg heavier than Chai. What is the mass of Ali?

- (1) 52 kg
- (2) 50 kg
- (3) 47 kg
- (4) 45 kg

- 13 In the figure, AOB is a straight line, $\angle AOD = 100^\circ$ and $\angle COB = 123^\circ$. Find $\angle COD$.

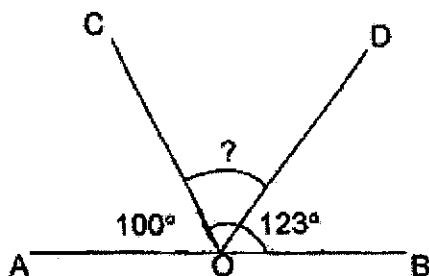

- (1) 23°
- (2) 43°
- (3) 57°
- (4) 80°

- 14 Ethan received \$200 as a prize. He gave \$70 to his mother. What percentage of the prize money did Ethan give to his mother?

- (1) 30%
- (2) 35%
- (3) 65%
- (4) 70%

- 15 A rectangular glass box is filled with some 1-cm cubes as shown below. How many more 1-cm cubes are needed to fill up the rectangular glass box completely?

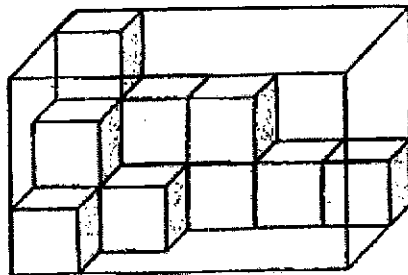

- (1) 13
- (2) 32
- (3) 36
- (4) 45

Booklet B

Questions 16 to 20 carry 1 mark each. Show your working clearly in the space provided for each question and write your answers in the spaces provided. For questions which require units, give your answers in the units stated. (5 marks)

16 What is 6% of 3100?

Ans: _____

17 Find the value of $10.5 - 0.99$.

Ans: _____

18 Arrange these fractions from the smallest to the largest.

$$\frac{7}{6}, 1\frac{1}{3}, \frac{4}{5}$$

Ans: _____
 smallest



- 19 The original price of a tablet was \$550. During a sale, Melvin was given a 30% discount for the tablet. How much did he pay for the tablet?

Ans: \$ _____

- 20 Find the value of 0.27×80 .

Ans: _____



Questions 21 to 30 carry 2 marks each. Show your working clearly in the space provided for each question and write your answers in the spaces provided. For questions which require units, give your answers in the units stated. (20 marks)

- 21 The figure is made up of four identical squares.
The area of each square is 36cm^2 . What is the perimeter of the figure?

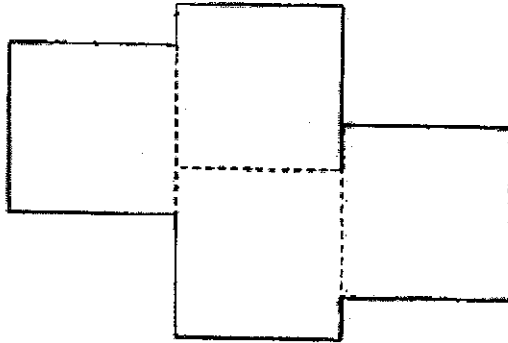

Ans: _____ cm

- 22 Three friends shared the cost of 60 mangoes in the ratio 1 : 2 : 2.
What was the cost of the smallest share?

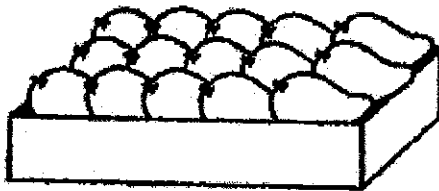

Special Offer
\$10 for one box of
15 mangoes

Ans: \$ _____

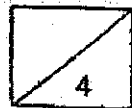

23 Joash stacked 14 unit cubes to form the solid below.

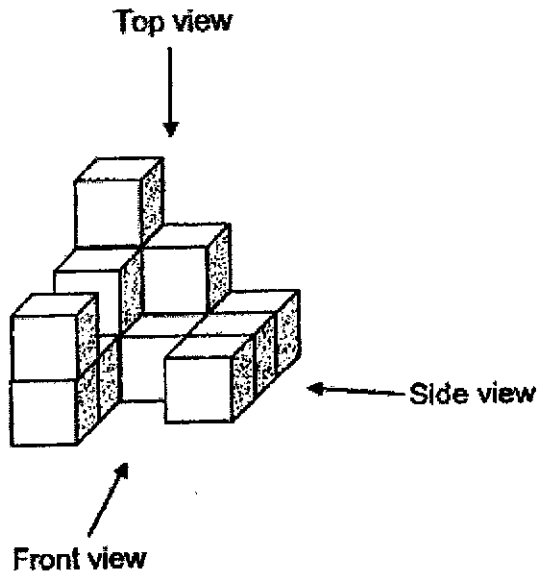

Draw the front view and the top view of the solid on the grids below.

Front View

•	•	•	•	•	•	•
•	•	•	•	•	•	•
•	•	•	•	•	•	•
•	•	•	•	•	•	•
•	•	•	•	•	•	•
•	•	•	•	•	•	•

Top View

•	•	•	•	•	•	•
•	•	•	•	•	•	•
•	•	•	•	•	•	•
•	•	•	•	•	•	•
•	•	•	•	•	•	•
•	•	•	•	•	•	•

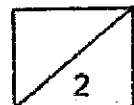

- 24 Ming drew three circles to form a figure. The areas of the circles were in the ratio 1 : 4 : 16. She then shaded some parts of the figure as shown. Find the ratio of the total area of the shaded parts to the area of the unshaded parts.

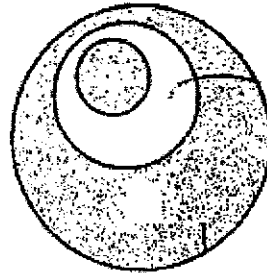

Ans: _____

- 25 ABCD is a parallelogram. $\angle ADE = 32^\circ$, $\angle DCE = 46^\circ$ and $\angle BCE = 54^\circ$. Find $\angle z$.

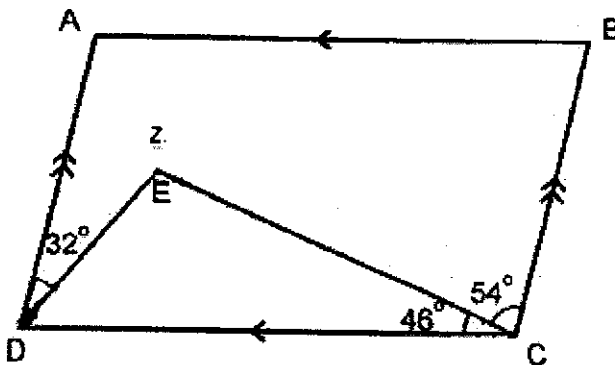

Ans: _____ °

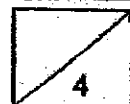

- 26 Priya spent $\frac{5}{9}$ of her money on some pens and $\frac{1}{4}$ of the remainder on 3 notebooks. A notebook cost 4 times as much as a pen. How many pens did she buy?

Ans: _____

- 27 The table below shows the rate of charges for each overdue book borrowed from a library.

OVERDUE CHARGES	
For the first 7 days	20¢ per day
After 7 days	50¢ per day

Peter borrowed a book from the library. The book was overdue when he returned it. He paid a total of \$3.90 for the overdue book. How many days was it overdue?

Ans: _____ days



- 28 Dexter has \$27 more than Asher. After Asher gave \$6 to Dexter, Dexter had 4 times as much money as Asher. What was the amount of money Asher had in the end?

Ans: \$ _____

- 29 In the figure below, ACD and BCE are straight lines. $\angle ABE = 55^\circ$, $\angle DEB = 114^\circ$ and $\angle DAB = 90^\circ$. Find $\angle ADE$.

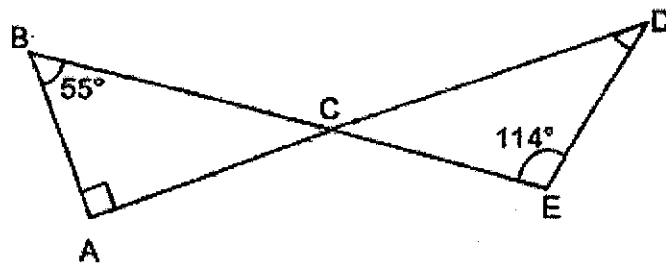

Ans: _____ °

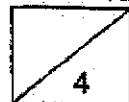

30 Triangle ABC is drawn by joining the dots on the square grid as shown below.

- (a) On the grid below, draw Triangle ACD with the same area as Triangle ABC. Triangle ACD does not overlap with Triangle ABC.

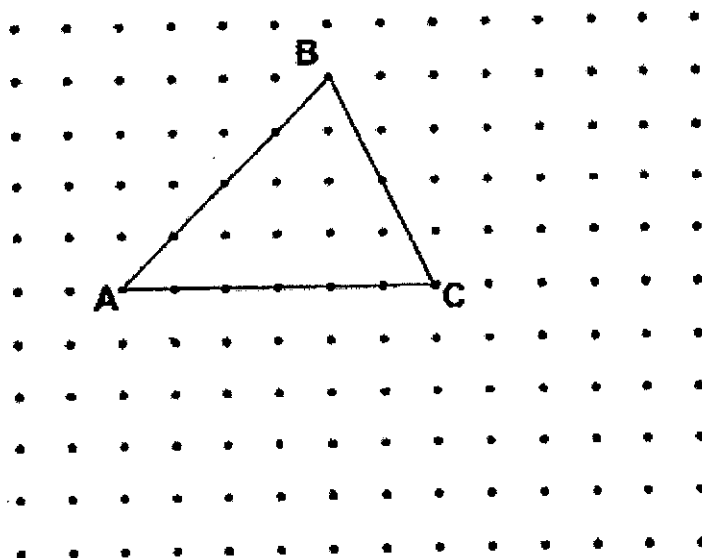

- (b) On the grid below, draw a square with thrice the area of Triangle ABC.

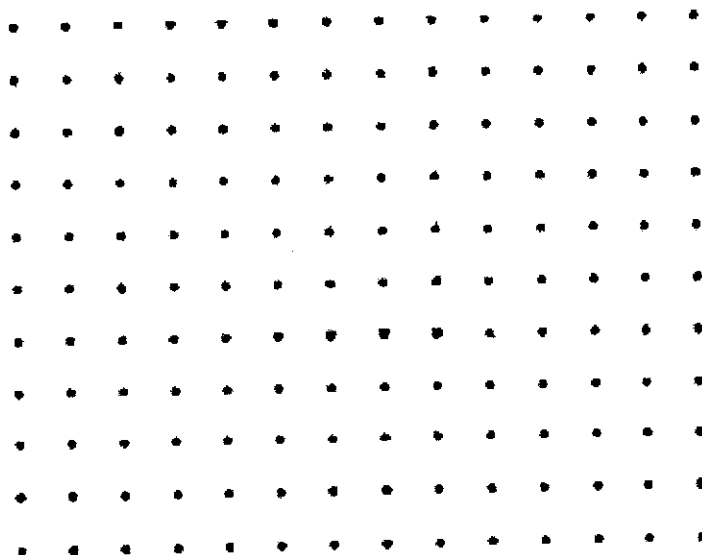

End of Paper 1

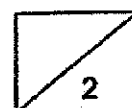



AI TONG SCHOOL
2023
END-OF-YEAR EXAMINATION
PRIMARY 5

MATHEMATICS
PAPER 2

DURATION : 1 h 30 min

DATE : 26 OCTOBER 2023

INSTRUCTIONS

Do not turn over this page until you are told to do so.

Follow all instructions carefully.

Answer all questions.

Write your answers in this booklet.

The use of an approved calculator is allowed.

Name: _____ ()

Class: Primary 5 _____

Marks :

Parent's Signature :	
Date :	

Paper 1		
Paper 2		45
Total		55
		100

- BLANK PAGE -

Paper 2

Questions 1 to 5 carry 2 marks each. Show your working clearly in the space provided for each question and write your answers in the spaces provided. For questions which require units, give your answers in the units stated. (10 marks)

- 1 Cathleen has 1.2 m of ribbon at first. She used 45 cm of it. What is the length of the ribbon left?

Ans: _____ m

- 2 The figure is made up of 3 identical squares. What percentage of the figure is shaded?

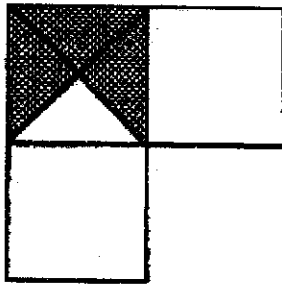

Ans: _____

- 3 A machine takes 2 min to print 3 posters. At this rate, how many posters will it print in 2 hours?

Ans: _____



- 4 7 chocolate bars weigh 384.51 g each. How much do they weigh altogether?
Round the answer to the nearest kilogram?

Ans: _____ kg

- 5 A bag containing 12 oranges weighs 980g. The mass of the empty bag is 20 g.
What is the average mass of 1 orange ?

Ans: _____ g



For questions 6 to 17, show your working clearly in the space provided for each question and write the answers in the spaces provided. The number of marks available is shown in the brackets [] at the end of each question or part-question.

(45 marks)

- 6 In the figure, ABCD is a parallelogram.
 $\angle ABD = 29^\circ$, $\angle ADB = 38^\circ$ and $\angle BCE = 66^\circ$.

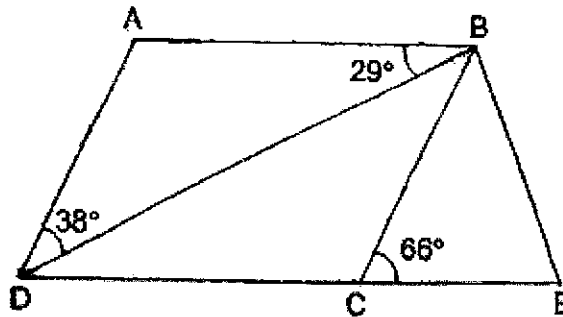

- (a) Find $\angle BCD$.

Ans : (a) _____ [2]

- (b) Circle the words that describe ABED correctly in the following statement.

ABED (is / is not) a trapezium and AB (is / is not) parallel to DE.

[1]



- 7 Patrick bought 15 rulers and 20 highlighters at \$50. He wanted to buy another highlighter but was short of 0.90. He decided to buy another ruler instead and had \$0.40 left. How much did each ruler cost?

Ans: _____ [3]

- 8 Mrs Lee had a bottle of syrup. She used 600 ml of the syrup in the morning and $\frac{1}{6}$ of the remaining syrup in the afternoon. After that, $\frac{1}{2}$ of the syrup was left. How much syrup was there in the bottle at first?

Ans: _____ [3]



- 9 Figure ABCDE has an area of 2140 cm^2 . ABD and CBE are straight lines. Find the area of the shaded triangle BDE.

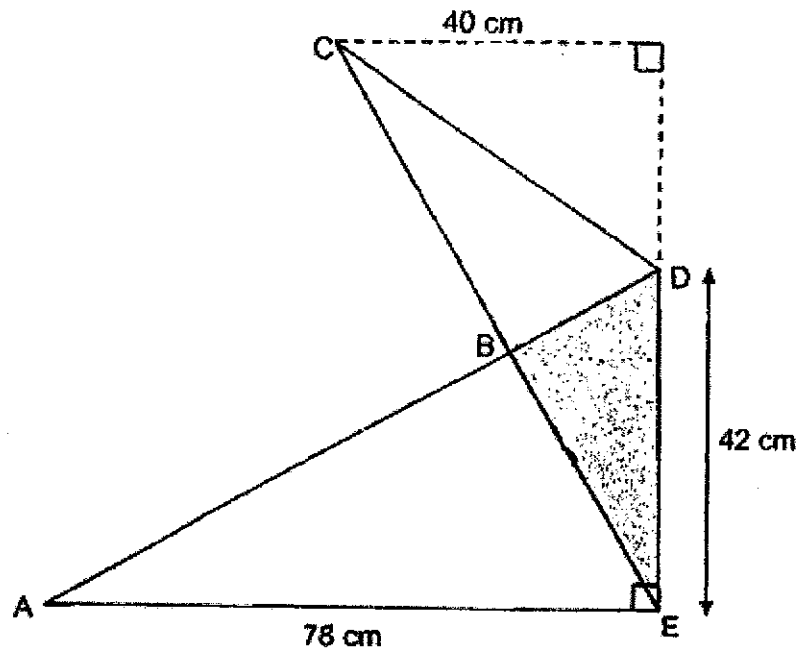

Ans: _____ [3]

- 10 The table below shows the number of books read by 40 students. One of the numbers in the table is covered by an ink blot.

Number of books read by each student	0	5	8	
Number of students	7	8	15	10

The average number of books read by the students is 7.
What is the number covered by the ink blot?

Ans: _____ [3]



- 11 ABCD is a rhombus. $\angle BAD = 55^\circ$ and $\angle DEC = 90^\circ$

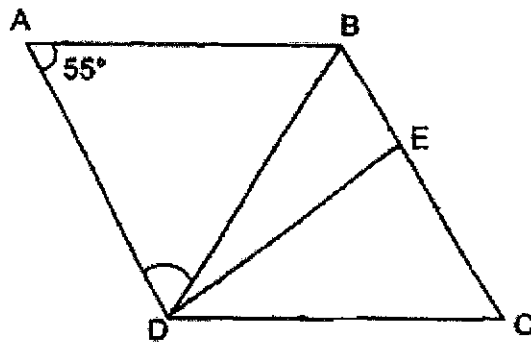

- (a) Find $\angle ADB$.

Ans : (a) _____ [2]

- (b) Find $\angle BDE$.

Ans : (b) _____ [2]



- 12 A tank was completely full of water at first. Water was drained out of the tank from 2 p.m. The line graph shows the volume of water in the tank from 2 p.m. to 8 p.m.

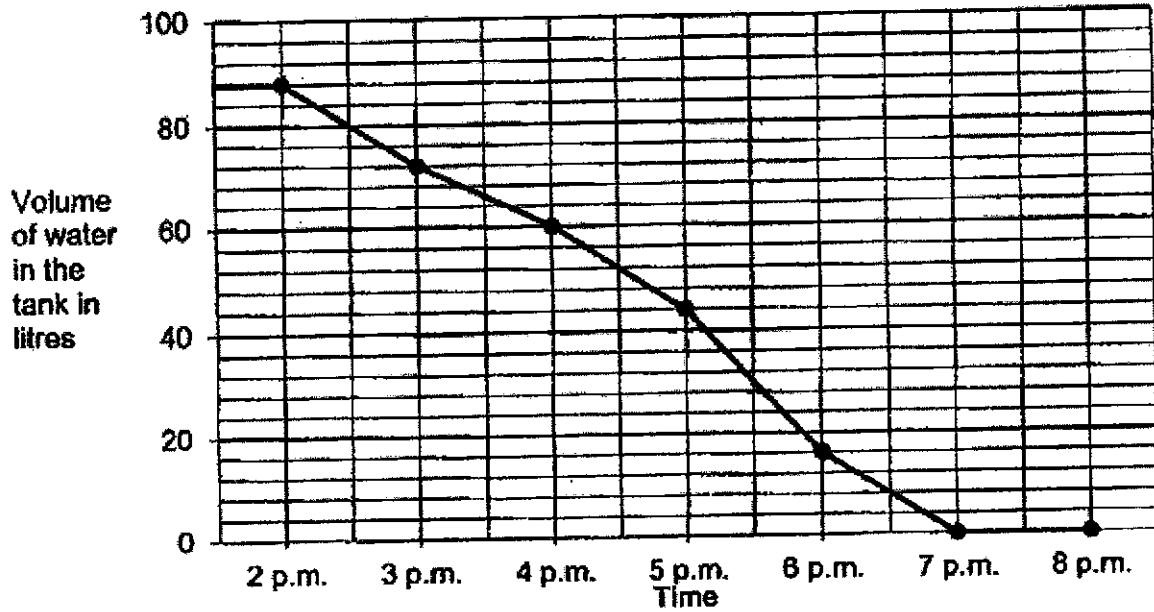

- (a) What was the decrease in volume of water from 5 p.m. to 6 p.m.?

Ans : (a) _____ [1]

- (b) At what time was the tank half-filled with water?

Ans : (b) _____ [2]

- (c) How long did it take for the tank to be emptied?

Ans : (c) _____ [1]

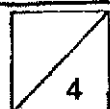

- 13 An open rectangular box measuring 80 cm by 50 cm by 72 cm is shown below. The box is packed full of 1-cm cubes.

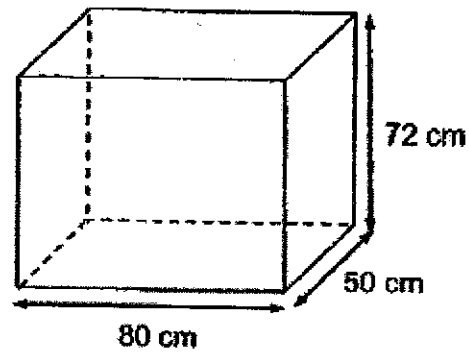

- (a) How many cubes are packed into the box?

Ans : (a) _____ [1]

- (b) How many cubes touch the inside of the box?

Ans : (b) _____ [3]



- 14 There are some books on a shelf $\frac{1}{3}$ of the books are fiction books and the rest are non-fiction books. $\frac{5}{7}$ of the non-fiction books are English books and the remaining 16 non-fiction books are in other languages.

(a) What fraction of the books on the shelf are English non-fiction books?

Ans : (a) _____ [2]

(b) How many fiction books are there on the shelf?

Ans : (b) _____ [3]



15 The first four figures of a pattern are shown below.

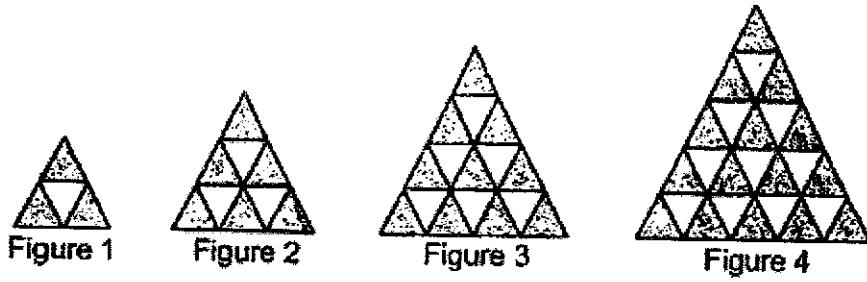

(a) The table shows the number of white and grey triangles used for each figure. Complete the table for Figure 5.

Figure Number	1	2	3	4	5
Number of white triangles	1	3	6	10	
Number of grey triangles	3	6	10	15	
Total number of triangles	4	9	16	25	

(b) A figure in the pattern has a total of 144 triangles. What is the Figure Number?

Ans : (b) _____ [1]

(c) In Figure 50 how many white triangles are there?

Ans : (c) _____ [3]



- 16 All 43 students from a class were assigned to welcome visitors at a school event. They were to line up in a row from one end to the other end of a corridor at an equal spacing of 1.2 m apart.

(a) How long was the corridor?

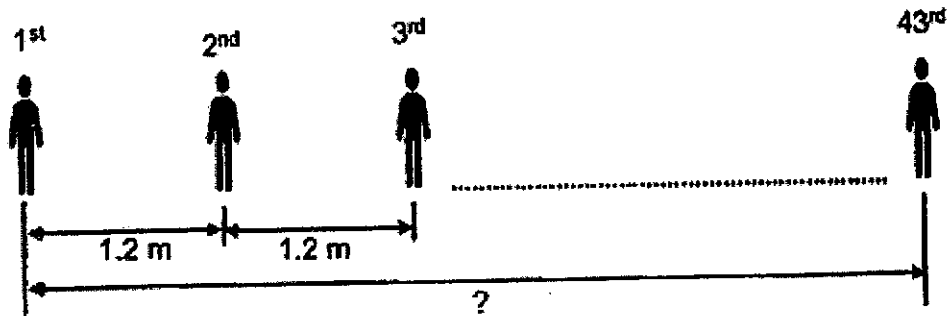

Ans : (a) _____ [2]

- (b) On the day of the event, 6 of the students did not turn up. As a result, the remaining students had to line up from one end to the other end of the corridor at a new equal spacing.

What was the new spacing between every 2 students?

Ans : (b) _____ [2]



- 17 The table below shows the charges for renting a bicycle.

	Days	Time	Charge
	Monday to Friday	9 a.m. to 5 p.m.	\$5 per hour
		5 p.m. to 8 p.m.	\$7 per hour
Saturday and Sunday	9 a.m. to 8 p.m.	\$8 per hour	

- (a) John rented a bicycle from 10 a.m. to 1 p.m. on Sunday. How much did he have to pay?

Ans : (a) _____ [1]

- (b) On Tuesday, Ken rented a bicycle and returned it at 7 p.m. He paid a total of \$29. What was the earliest time he rented the bicycle?

Ans : (b) _____ [3]

End of Paper

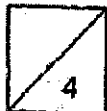

SCHOOL : AI TONG PRIMARY SCHOOL
LEVEL : PRIMARY 5
SUBJECT : MATHEMATICS
TERM : 2023 PRELIM

PAPER 1 (BOOKLET A)

Q1	3	Q2	3	Q3	1	Q4	3	Q5	3
Q6	3	Q7	3	Q8	4	Q9	4	Q10	1
Q11	4	Q12	1	Q13	2	Q14	2	Q15	2

PAPER 1 (BOOKLET B)

Q16	186
Q17	9.51
Q18	$\frac{4}{5}, \frac{7}{6}, 1\frac{1}{3}$
Q19	\$385
Q20	21.6
Q21	60cm
Q22	\$8
Q23	<div style="display: flex; justify-content: space-around; align-items: center;"> <div style="text-align: center;"> <p>Front View</p> </div> <div style="text-align: center;"> <p>Top View</p> </div> </div>
Q24	13:3
Q25	274°
Q26	60
Q27	12 days
Q28	\$13
Q29	31°

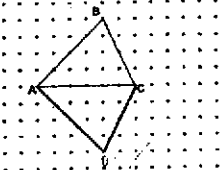
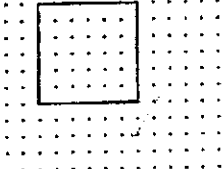
Q30a	
Q30b	

PAPER 2

Q1	0.75 m
Q2	$\frac{3}{12} \times 100\% = 25\%$
Q3	$120 \div 2 = 60$ $60 \times 3 = 180$
Q4	$384.51 \times 7 = 2691.57$ $\approx 3000 \text{ g}$ $= 3 \text{ kg}$
Q5	$980 - 20 = 960$ $960 \div 12 = 80 \text{ g}$
Q6a	$\angle BCD = \angle BAD$ $\angle BAD = 180^\circ - 29^\circ - 38^\circ = 113^\circ$
Q6b	Is not, is not
Q7	$\$0.90 + \$0.40 = \$1.30$ Assume all rulers $\$1.30 \times 20 = \26 $\$54 - \$26 = \$28$ $\$28 \div 35 = \0.80
Q8	$4u = 600 \text{ ml}$ $1u = 150 \text{ ml}$ $10u = 1500 \text{ ml}$
Q9	Area of ADE = $0.5 \times 78 \times 42 = 1638 \text{ cm}^2$ Area of CDE = $0.5 \times 40 \times 42 = 840 \text{ cm}^2$ Area of BDE = $(1638 + 840) - 2140 = 338 \text{ cm}^2$
Q10	Total books read = $40 \times 7 = 280$ $280 - (5 \times 8) - (15 \times 8) = 120$ No. covered = $120 \div 10 = 12$
Q11a	$\angle ADB = (180^\circ - 55^\circ) \div 2 = 62.5^\circ$

Q11b	$\angle BDE = 62.5^\circ - 35^\circ = 27.5^\circ$
Q12a	28 ¢
Q12b	5pm
Q12c	5 hours
Q13a	$80 \times 50 \times 72 = 288000$
Q13b	No. of cubes that do not touch = $(80 - 2) \times (50 - 2) \times (72 - 1) = 265824$ No. of cubes that touch = $288000 - 265824 = 22176$
Q14a	Fiction : Non-fiction 7 : 14 Non-fiction English books = 10u Non-fiction other languages = 4u Fraction = $\frac{10}{21}$
Q14b	4u = 16 1u = 4 7u = 28
Q15a	White = 15, grey = 21, total = 36
Q15b	11
Q15b	1275
Q16a	No. of gaps = 42 $1.2 \times 42 = 50.4$ m
Q16b	$43 - 6 = 37$ No. of gaps = 36 $50.4 \div 36 = 1.4$ m
Q17a	Duration = 3 hours Amount to pay = $\$8 \times 3 = \24
Q17b	5pm to 7pm \rightarrow 2 hours $2 \times \$7 = \14 $\$29 - \$14 = \$15$ $\$15 \div \$5 = 3$ 3 hours before 5pm = 2pm

