

**Red Swastika School
Primary 5
Class Test 2
Mathematics**

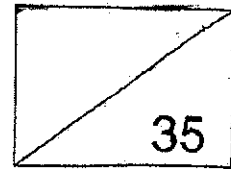

Name: _____ () Date: 16 August 2024

Class: Pr 5 / _____ Duration: 45 minutes
(Use of calculators is not allowed)

Parent's Signature: _____

Questions 1 to 2 carry 1 mark each. Questions 3 to 5 carry 2 marks each. For each question, four options are given. One of them is the correct answer. Make your choice (1, 2, 3 or 4) and write its number in the brackets provided. (8 marks)

1 What is the value of the digit 3 in 23 195?

- (1) 30
- (2) 300
- (3) 3000
- (4) 30 000

()

2 Round 5.646 to the nearest tenth.

- (1) 5.6
- (2) 5.7
- (3) 5.64
- (4) 5.65

()

3 Arrange the following from the largest to the smallest.

0.103 , 0.013 , 0.03

- (1) 0.03 , 0.013 , 0.103
- (2) 0.103 , 0.03 , 0.013
- (3) 0.013 , 0.03 , 0.103
- (4) 0.013 , 0.103 , 0.03

()

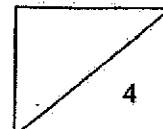

- 4 The following cuboid is built using 1-cm cubes. What is the volume of the cuboid?

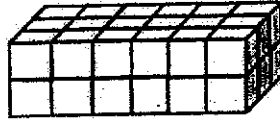

- (1) 12 cm^3
 (2) 18 cm^3
 (3) 25 cm^3
 (4) 36 cm^3

()

- 5 Minghui and Siling shared the cost of a birthday gift. The ratio of Minghui's share to Siling's share was $2 : 3$. Siling paid \$18 for her share. How much did the gift cost?

- (1) \$12
 (2) \$27
 (3) \$30
 (4) \$45

()

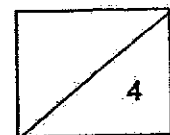

Questions 6 to 13 carry 2 marks each. Write your answers in the spaces provided. For questions which require units, give your answers in the units stated. (16 marks)

- 6 (a) Write twenty-four thousand and fifty in numerals.

Ans: (a) _____

- (b) What is the remainder when 3406 is divided by 7?

Ans: (b) _____

- 7 (a) Find the value of $15.14 - 7.89$

Ans: (a) _____

- (b) Express 0.28 as a fraction in its simplest form.

Ans: (b) _____

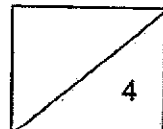

8 Study the following solid.

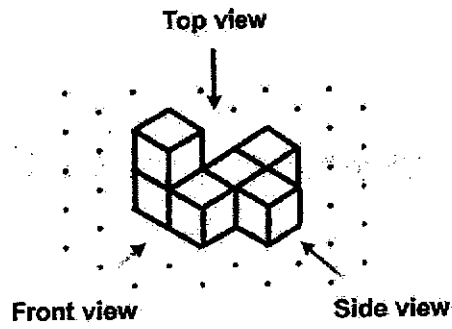

(a) Draw the top view of the solid on the square grid provided.

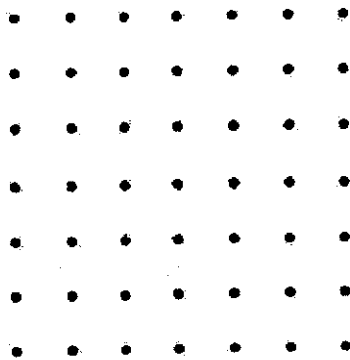

(b) What is the least number of unit cubes to be added to the solid to form a cube?

Ans: (b) _____

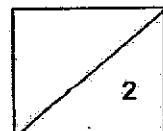

- 9 (a) What is the missing number in the box?

$$12 : 15 = 28 : \boxed{?}$$

Ans: (a) _____

- (b) What is the ratio of the area of the shaded parts to the area of the whole figure?

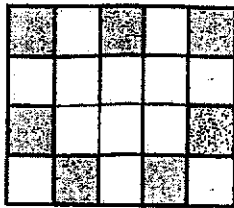

Ans: (b) _____

- 10 The diagram below shows the cost of a watch before GST. What was the price of the watch after adding 9% GST?

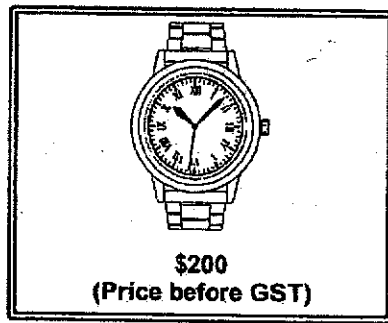

Ans: \$ _____

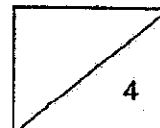

- 11 A cubical container of edge 10 cm is $\frac{4}{5}$ filled with water. How much more water is needed to fill the container completely?

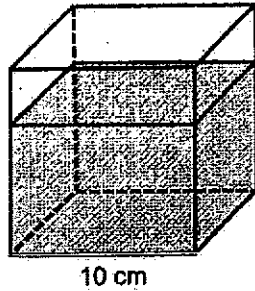

Ans: _____ cm^3

- 12 Amy mixed 1.2 litres of blue paint with twice as much red paint to get purple paint. She then poured the purple paint into 100 small containers. How many litres of paint were there in 20 such containers?

Ans: _____ litres

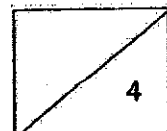

- 13 Ahmad drew two triangles and a circle to form a figure. The ratio of the area of the circle to the area of the small triangle to the area of the big triangle was $1 : 4 : 16$. He then shaded some parts of the figure as shown. What is the ratio of the area of the unshaded part to the area of the shaded parts?

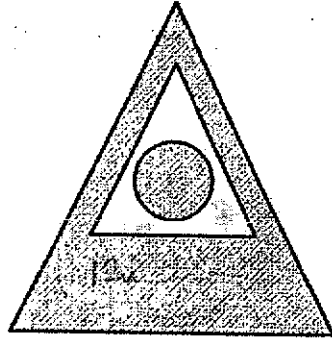

Ans: _____

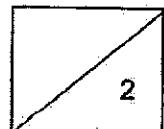

For Questions 14 and 16, show your workings clearly in the space below each question and write your answers in the spaces provided. The number of marks available is shown in brackets [] at the end of each question or part-question. (11 marks)

- 14 The figure shows the amount of water in two rectangular tanks, A and B, at first. Tank A was filled to the brim and there was some water in Tank B.

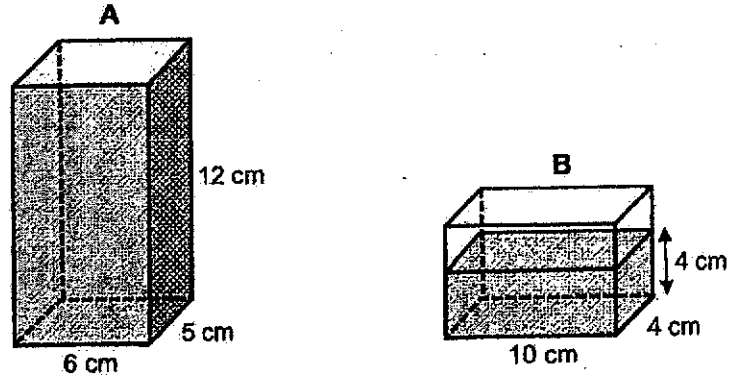

- (a) What is the volume of water in Tank A at first?

Ans: (a) _____ [1]

- (b) Mrs Lim poured $\frac{1}{3}$ of the water from Tank A into Tank B to fill it to its brim. What is the volume of Tank B?

Ans: (b) _____ [3]

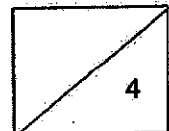

- 15 The participants of a race are divided equally into Group A and Group B. Group A has 20 more boys than girls, while Group B has 12 more girls than boys. 45% of the participants are girls.

(a) What percentage of the participants are boys?

Ans: (a) _____ [1]

(b) How many participants are there in each group?

Ans: (b) _____ [3]

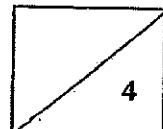

- 16 Miss Wong had packets of two different sizes, large and small. She filled 3 large packets and 5 small packets to their full capacity with 7.2 kg of rice.

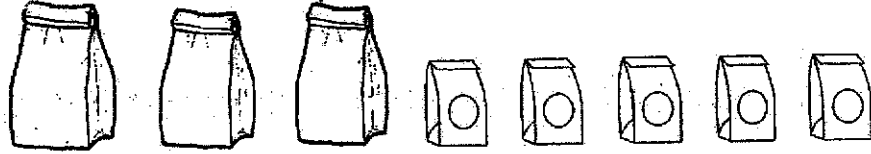

Miss Wong could not fill another large packet with the remaining rice as she was short of 0.5 kg. Instead, she filled another small packet and had 0.3 kg of rice left. How much rice was there in each small packet?
(Leave your answer in grams)

Ans: _____ [3]

End of paper

Have you checked your work?

10

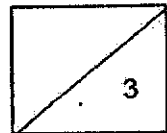

ANSWER KEY

YEAR : 2024
 LEVEL : PRIMARY 5
 SCHOOL : RED SWASTIKA
 SUBJECT : MATHEMATICS
 TERM : WA 2

Q1	3	Q2	1	Q3	2	Q4	4	Q5	3
----	---	----	---	----	---	----	---	----	---

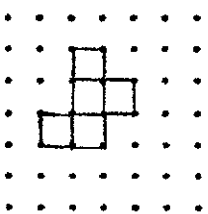
Q6	a) $24000 + 50 = 24050$ b) $3406 \div 7 = 486R4$	Q7	a) $15.14 - 7.89 = 7.25$ b) $0.28 = \frac{28}{100} = \frac{7}{25}$
Q8	 a) b) $3 \times 3 \times 3 = 27$ $27 - 6 = 21$	Q9	a) $\frac{15}{3} \times 7 = 35$ b) $7 : 20$
Q10	$100 + 9 = 109$ $200 \times 109 = 200 \times \frac{109}{100} = \218	Q11	$10 \times \frac{4}{5} = 8$ $10 \times 10 \times 10 = 1000$ $10 \times 10 \times 8 = 100 \times 8 = 800$ $1000 - 800 = 200cm^3$
Q12	$3u = 1.2 \times 3 = 3.6$ 20 container = $3.6 \div 100 \times 20$ = 0.72 litres	Q13	$4 - 1 = 3$ $16 - 4 + 1 = 13$ Unshaded : Shaded 3 : 13
Q14	a) $12 \times 6 \times 5 = 360 cm^3$ = 360ml b) $12 \times \frac{1}{3} = 4$ $4 \times 30 = 120$ $120 \div (10 \times 4) = 120 \div 40$ = 3 $3 + 4 = 7$ Volume of B $\rightarrow 7 \times 10 \times 4$ = $280cm^3$	Q15	a) $100 - 45 = 55\%$ b) $8 \rightarrow 10\%$ $50\% \rightarrow 8 \times 5 = 40$
Q16	LP = Large Packet SP = Small Packet LP - 0.5kg = SP + 0.3kg		

$LP - SP = 0.5\text{kg} + 0.3\text{kg} = 0.8\text{kg}$ $0.8 \times 3 = 2.4$ $7.2 - 2.4 = 4.8$ Small packet = $48 \div 8 = 0.6$ $0.6\text{kg} = 600\text{g}$		
---	--	--

2
END