

SINGAPORE CHINESE GIRLS' SCHOOL
SECOND SEMESTRAL ASSESSMENT 2019
SCIENCE
PRIMARY FIVE

NAME: _____ ()

DATE: 21 October 2019

CLASS: PRIMARY 5 SY / C / G / SE / P

BOOKLET A

28 questions

56 marks

Total time for Booklets A & B: 1 h 45 min

DO NOT OPEN THIS BOOKLET UNTIL YOU ARE TOLD TO DO SO.

FOLLOW ALL INSTRUCTIONS CAREFULLY.

Booklet A (56 marks)

For each question from 1 to 28, four options are given. One of them is the correct answer. Make your choice (1, 2, 3 or 4). Shade the correct oval (1, 2, 3 or 4) on the Optical Answer Sheet.

1. Study the diagram below.

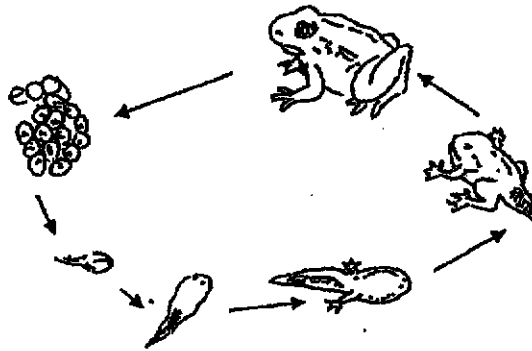

The diagram above shows that living things can _____.

A: reproduce
B: grow

C: breathe
D: die

1) A and B only
2) A and C only

3) B and C only
4) B and D only

2. The table shows the characteristics of four animals. Which animal best represents a cow?

Animal	Suckles its young	Gives birth	Has six legs
P			✓
Q	✓	✓	
R		✓	
S		✓	✓

1) Animal P
2) Animal Q

3) Animal R
4) Animal S

3. Four materials with the same mass are fully soaked in a pail of water. They are removed and weighed after 20 minutes. Their masses before and after soaking are recorded in the graph shown below.

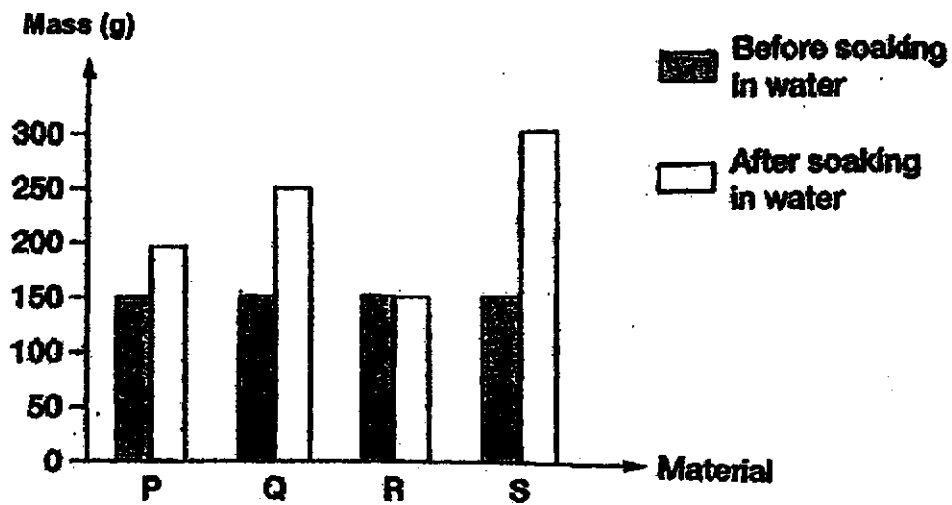

Which material is best for making a water bottle?

- | | |
|---------------|---------------|
| 1) Material P | 3) Material R |
| 2) Material Q | 4) Material S |
4. Sandy set up an electric circuit as shown below.

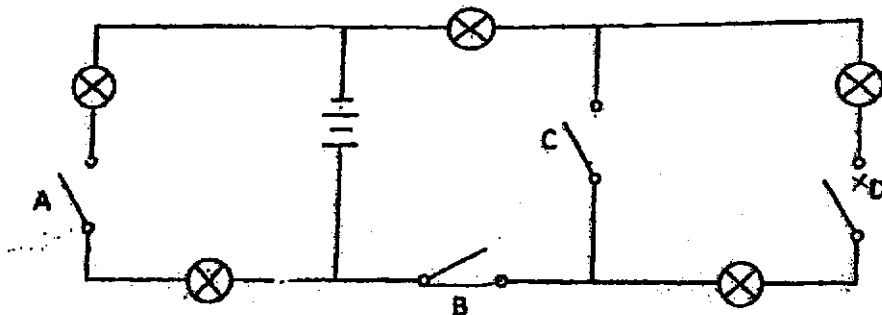

Switches A, B and C were closed.

How many bulbs lighted up?

- | | |
|------|------|
| 1) 1 | 3) 3 |
| 2) 2 | 4) 4 |

5. Diane had just eaten a bowl of noodles. The food that she had eaten would be digested with the help of digestive juices produced in the _____.

A: stomach

B: gullet

C: small intestine

D: anus

E: large intestine

F: mouth

1) A and B only

2) A and C only

3) A, C and F only

4) A, C and E only

6. Andy was trapped in a lift with his friends for one hour due to a lift breakdown. The air-conditioner inside broke down too.

Which of the following shows how the different gases in the air inside the lift changed after one hour?

	Amount of oxygen	Amount of carbon dioxide	Amount of water vapour
1)	Decreased	Increased	Increased
2)	Decreased	Increased	Remain unchanged
3)	Increased	Decreased	Increased
4)	Increased	Decreased	Remain unchanged

7. Some cells were obtained from an organism and studied under a microscope. The parts of each cell are listed below.

- Nucleus
- Cell membrane
- Cytoplasm
- Chloroplast

Which of the following were the cells most likely obtained from?

- 1) Root of a daisy plant
2) Feather of a pigeon

- 3) Leaf of a rose plant
4) Cheek of a girl

8. Four blood samples, A, B, C and D, were taken from different blood vessels in a human body and represented by four arrows in the diagram below.

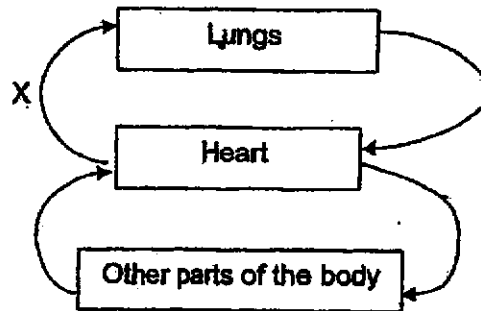

The graph below shows the amount of oxygen in each blood sample.

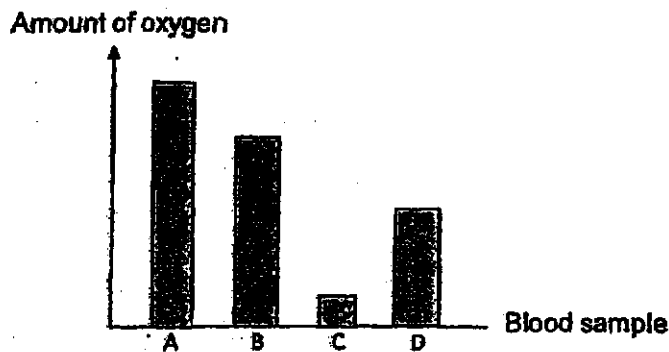

Which blood sample best represents the amount of oxygen in blood vessel X?

- 1) A 2) B 3) C 4) D
9. Jonathan did the following to four similar leaves on the same plant.



Leaf A

Upper side is coated with oil



Leaf B

Underside is coated with oil



Leaf C

Both sides are coated with oil

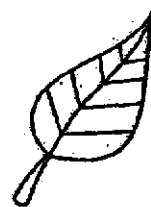

Leaf D

Not coated with oil at all

He left the plant out in the sun for three hours.
Which leaf will have the most amount of water loss?

- 1) Leaf A 3) Leaf C
2) Leaf B 4) Leaf D

10. Four clips made of different materials are attached to a sheet of metal.

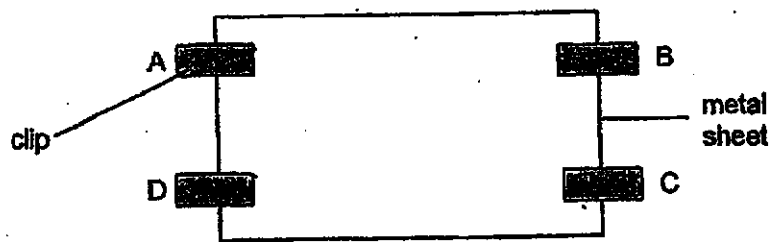

A circuit tester with a bulb is connected to two clips at a time. The table below shows the results obtained.

Clips tested	Does the bulb light up?
A and B	No
A and C	Yes
A and D	Yes
B and C	No
B and D	No
C and D	Yes

Which clips are made of electrical conductors?

- 1) A, B and C only
 2) A, C and D only
 3) A, B and D only
 4) B, C and D only
11. In the circuit below, one of the four bulbs has fused. All the remaining light bulbs still remain lit.

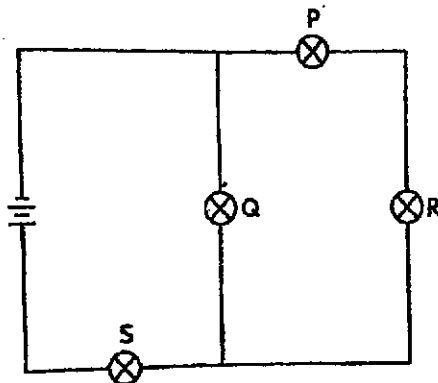

Which of the bulbs has fused?

- 1) P
 2) Q
 3) R
 4) S

12. James was given a battery and a light bulb. However, he did not have any wire to set up a circuit with the battery and light bulb.

Which of the following can he use instead of a wire?

A: Aluminium clip
B: Rubber band

C: Cotton string
D: Silver chain

- 1) A and D only
2) B and D only

- 3) C and D only
4) B and C only

13. The diagrams below show what happens when a magnet is brought near materials A and B.

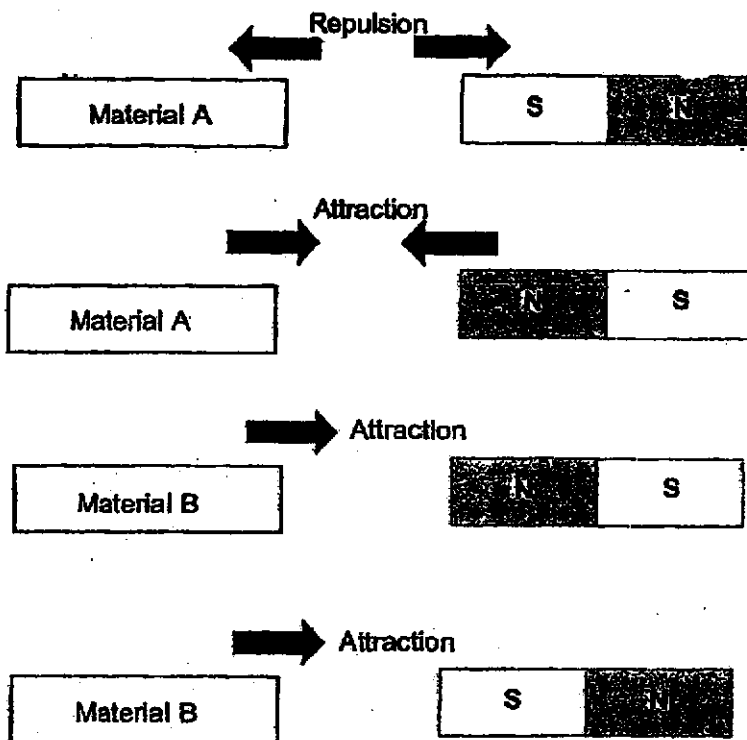

What can we infer from the diagrams?

- A: Material A is a magnet.
B: Material A is a magnetic material only.
C: Material B is a magnet.
D: Material B is a magnetic material only.

- 1) A and B only
2) A and C only

- 3) A and D only
4) B and D only

14. Dennis wanted to make iron rods A, B, C and D into new magnets. She stroked four identical iron rods with the same magnet in one direction.

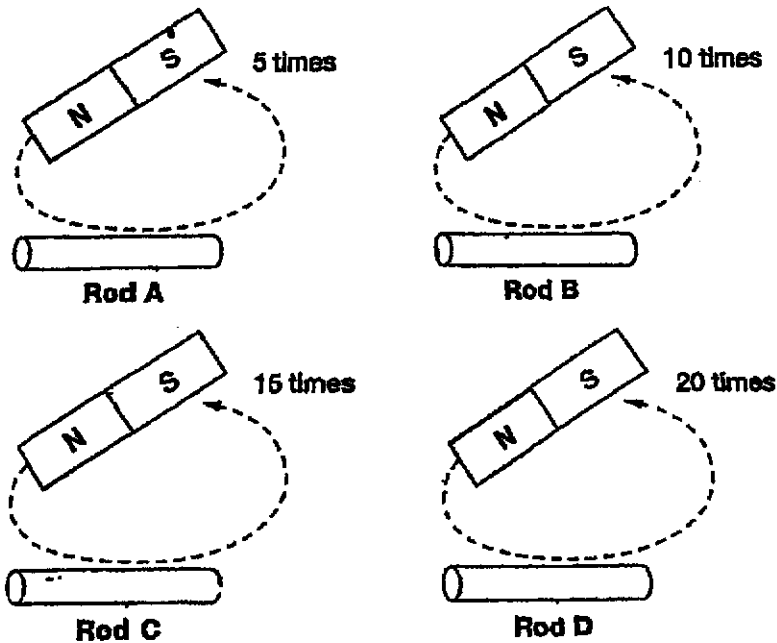

Arrange the iron rods in order from the strongest to the weakest new magnets.

- 1) A, B, C, D
 - 2) B, C, D, A
 - 3) C, D, A, B
 - 4) D, C, B, A
15. In a research laboratory, a group of Science students conducted a study on the eggs of different animals. The experimental set-up consists of four identical jars, each containing an equal number of eggs of different animals.

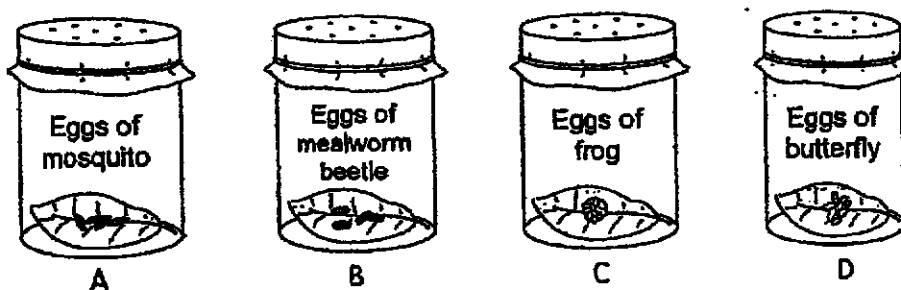

In which jars would the eggs develop into the next stage?

- 1) A and C only
- 2) B and D only
- 3) B and C only
- 4) A and D only

16. The diagrams below show the reproductive systems in a flowering plant and in a human.

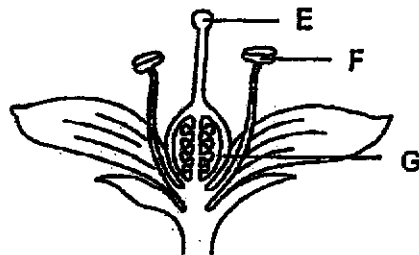

Reproductive system in a flowering plant

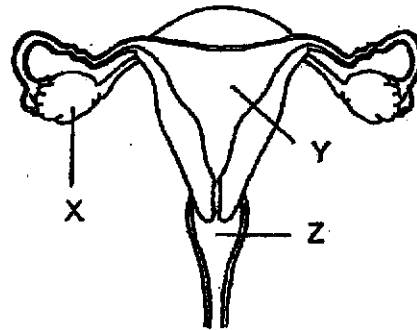

Reproductive system in a human

Which of the following statements is correct?

- 1) E and X produce reproductive cells.
- 2) F and X contain reproductive cells.
- 3) G and Z perform the same function.
- 4) Y and F perform the same function.

17. Study the diagram of a balance below carefully.

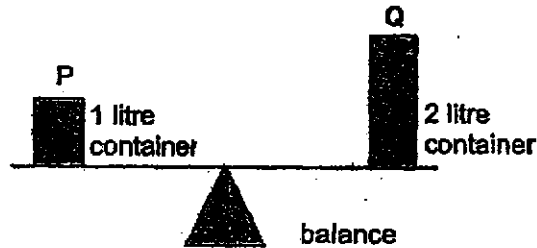

Which of the following statements are true?

- A: P and Q have the same mass.
- B: Q is heavier than P.
- C: Q has a larger volume than P.
- D: P and Q are matter.

- 1) A and C only
- 2) B and C only

- 3) A and D only
- 4) A, C and D only

18. The diagram below shows Colin's family tree and how the characteristic, brown hair, is passed down in the family.

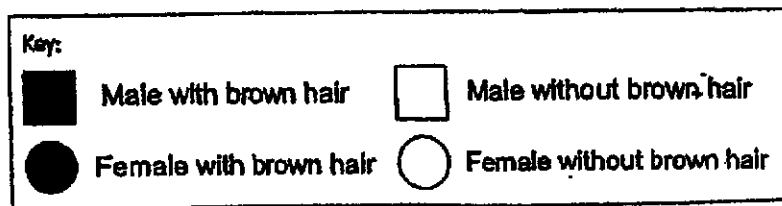
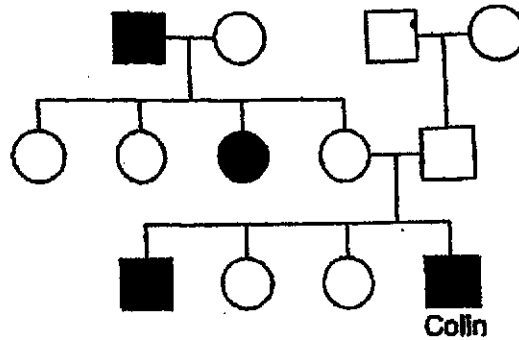

Based on the family tree, which one of the following statements is most likely to be true?

- 1) Colin inherited brown hair from his aunt.
 - 2) Colin inherited brown hair from his brother.
 - 3) Colin inherited brown hair from his maternal grandfather.
 - 4) Colin's children will definitely have brown hair.
19. Which of the following shows the correct order of the processes involved in the reproduction of a flowering plant?

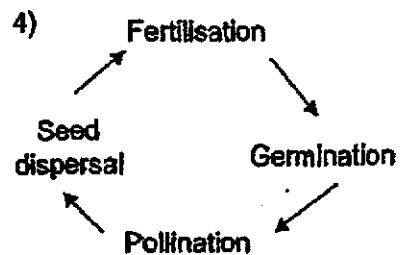
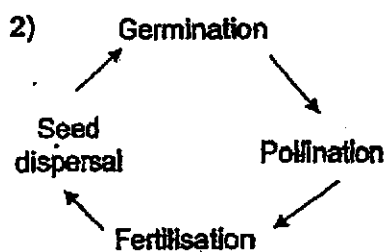
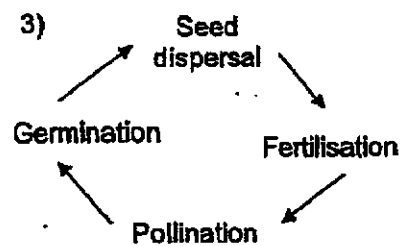
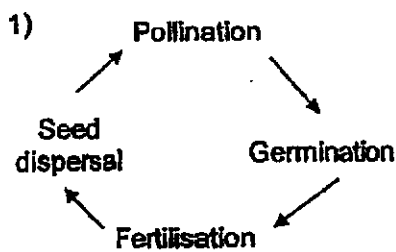

20. The diagram below shows a beaker of water being heated from room temperature.

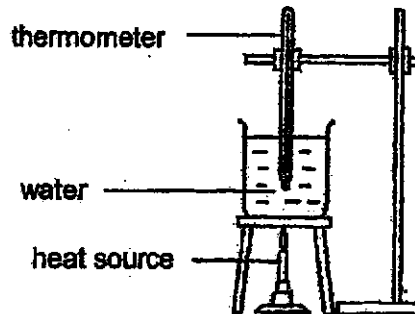

Which one of the following is correct?

	Temperature of water	Water in beaker
1)	Increase	Gain heat
2)	Increase	Lose heat
3)	Decrease	Gain heat
4)	Decrease	Lose heat

21. In the table below, the three states of matter are represented by W, X and Y.

W	Has no definite shape and can be compressed.
X	Has a definite shape and cannot be compressed.
Y	Has no definite shape and cannot be compressed.

Which of the following classifications is correct?

	W	X	Y
1)	Plastic cube	Water vapour	Oil
2)	Oil	Water vapour	Plastic cube
3)	Water vapour	Plastic cube	Oil
4)	Water vapour	Oil	Plastic cube

22. An ice cube at 0°C was taken out from the freezer and placed on a metal plate as shown below.

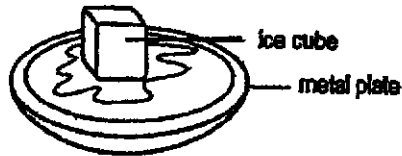

Which of the following correctly describe the temperature of the ice cube, the metal plate and the surrounding air during the process of melting?

	Temperature		
	Ice cube	Metal plate	Surrounding air
1)	Increases	Decreases	Increases
2)	Increases	Decreases	Decreases
3)	Remains the same	Decreases	Decreases
4)	Remains the same	Increases	Decreases

23. Leslie left a cup of hot tea on a table for one hour.



Which of the following graphs correctly shows how the temperature of the tea changed with time?

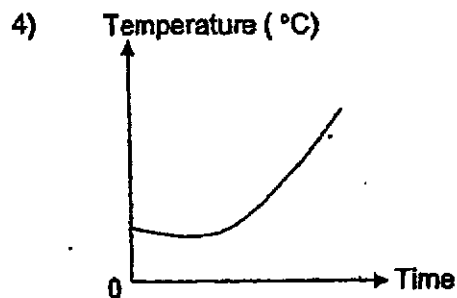
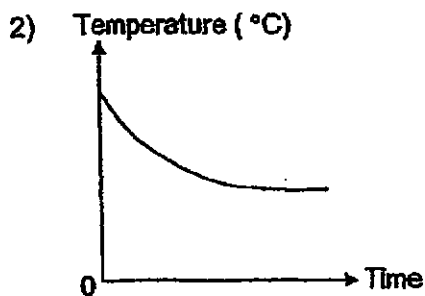
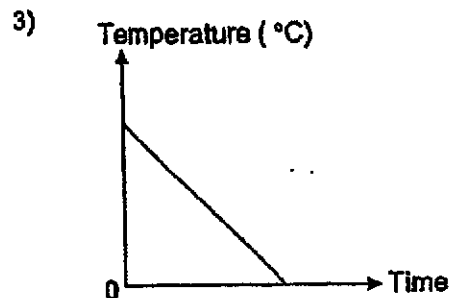
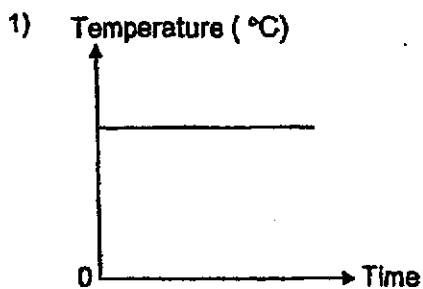

24. Sarah lights the candle in the set-up below.

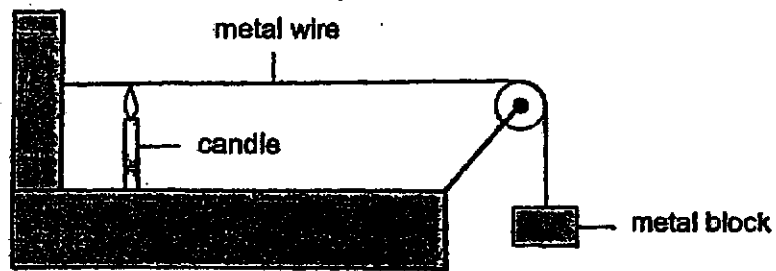

What will Sarah observe about the position of the metal block after some time?

	Height of metal block	Metal wire
1)	Hang higher	Contracts
2)	Hang higher	Expands
3)	Hang lower	Contracts
4)	Hang lower	Expands

25. Study the table below.

Good conductors of heat	Poor conductors of heat
Copper Aluminium A	Plastic Wool B

Which of the following are A and B most likely to be?

	A	B
1)	Silver	Air
2)	Gold	Iron
3)	Rubber	Steel
4)	Wood	Paper

26. Mark was skateboarding in the park one evening when he saw a tree and a lit lamp post in front of him.

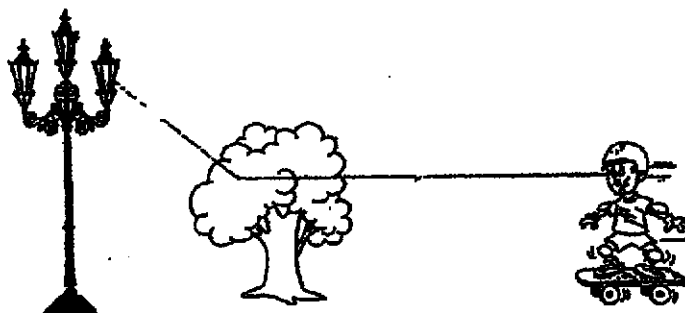

The diagram below shows how Mark was able to see the tree and the lit lamp post. The arrows represent the paths of light.

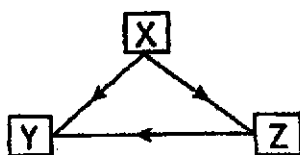

Which of the following represents X, Y and Z?

	X	Y	Z
1)	Lamp post	Tree	Mark
2)	Lamp post	Mark	Tree
3)	Tree	Lamp post	Mark
4)	Mark	Lamp post	Tree

27. Four containers made of material P, Q, R and S are filled completely with oil at different temperatures as shown below.

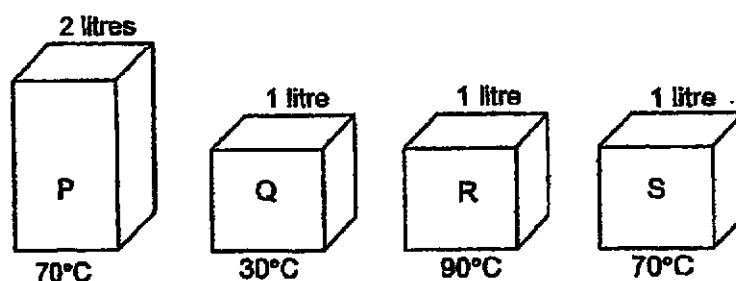

Based on the diagrams, which of the following statements are definitely true?

- A: P has more heat energy than S.
- B: Q has more heat energy than R.
- C: R has more heat energy than P.
- D: S has more heat energy than Q.

- 1) A and D only
- 2) A and B only

- 3) B and C only
- 4) B and D only

28. The diagram below shows light shining on an opaque pyramid in a dark room from two different positions.

The pyramid is made up of four equilateral triangles and a square base.

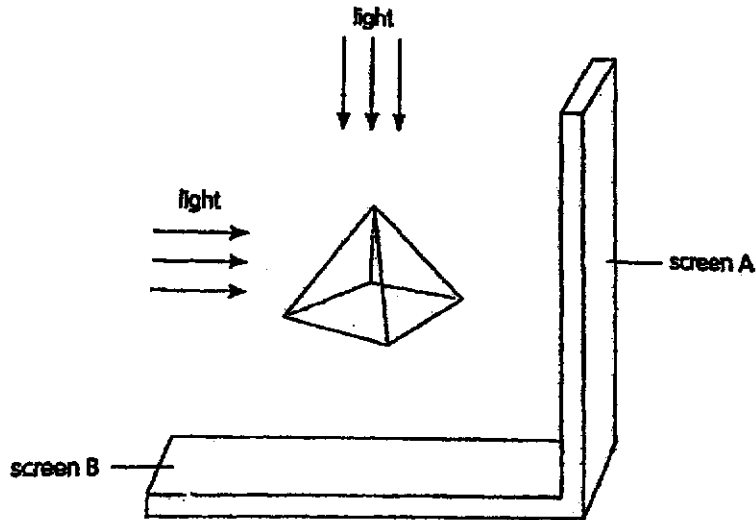

Which of the following correctly shows the shapes of the shadows formed on screens A and B?

	Screen A	Screen B
1)		
2)		
3)		
4)		

—

SINGAPORE CHINESE GIRLS' SCHOOL
SECOND SEMESTRAL ASSESSMENT 2019
SCIENCE
PRIMARY FIVE

NAME: _____ (.)

DATE: 21 October 2019

CLASS: PRIMARY 5 SY / C / G / SE / P

Booklet A		56
Booklet B		44
Total		100

Parent's Signature _____

BOOKLET B

12 questions

44 marks

Total time for Booklets A & B: 1 h 45 min

DO NOT OPEN THIS BOOKLET UNTIL YOU ARE TOLD TO DO SO.

FOLLOW ALL INSTRUCTIONS CAREFULLY.

Booklet B (44 marks)

Answer all the following questions.

29. Study the classification diagram below.

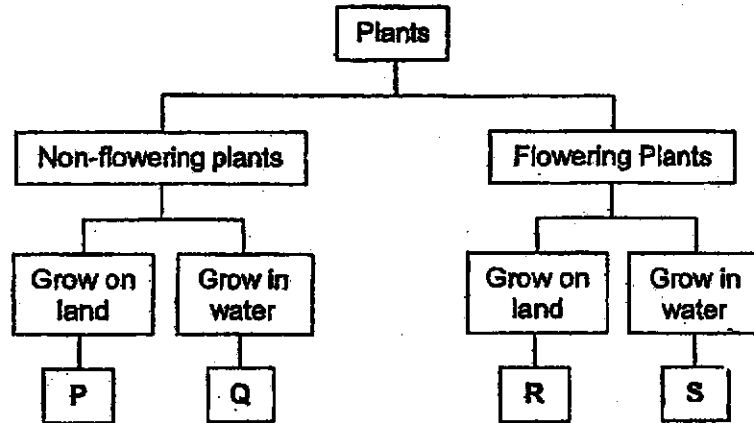

a) State the characteristics of Q. [1m]

b) State the method of reproduction by P and Q. [1m]

c) Si Ying was given four plants below.
Fit the plants correctly in the flow chart above by matching them to P, Q, R and S.





- Rose plant : _____
- Lotus plant : _____
- Bird's nest fern : _____
- Water moss fern: _____

[2m]



30. Jerell was given a plant cell and an animal cell. He placed the two cells on separate glass slides. He then added liquid S and observed the cells using a microscope.

The table below shows his observations on the shape of the cells before and after liquid S was added.

	Before adding liquid S	After adding liquid S
Cell A		
Cell B		

a) Based on Jerell's observations, state which cell is the plant cell and which cell is the animal cell. [1m]

Cell A: _____

Cell B: _____

b) Name the cell part of Cell A that enables it to maintain its shape. [1m]

c) Which cell part of Cell B enables the cell to become bigger after adding liquid S? [1m]

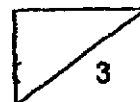

31. Rizal carried out an experiment to test four different materials, J, K, L and M using the set-up shown below. He used a light sensor to measure the amount of light reflected by each material.

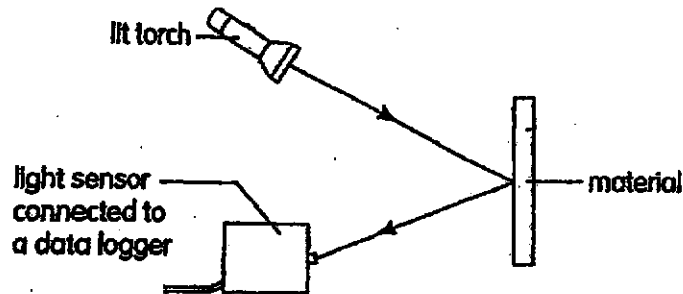

- a) Explain why Rizal conducted his experiment in a dark room. [1m]

Rizal recorded his results in the table below.

	Material J	Material K	Material L	Material M
Amount of light reflected (units)	80	150	210	130

- b) From the results, which material, J, K, L or M reflects the least amount of light. [1m]

- c) Motorists may get into accidents if they cannot see road signs clearly at night.

Which material, J, K, L or M is the most suitable material to be made into a road sign? Explain your answer. [2m]

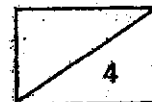

32. Shaun wanted to investigate the factors affecting the rate of evaporation of water. He prepared four set-ups as shown in the diagrams below.

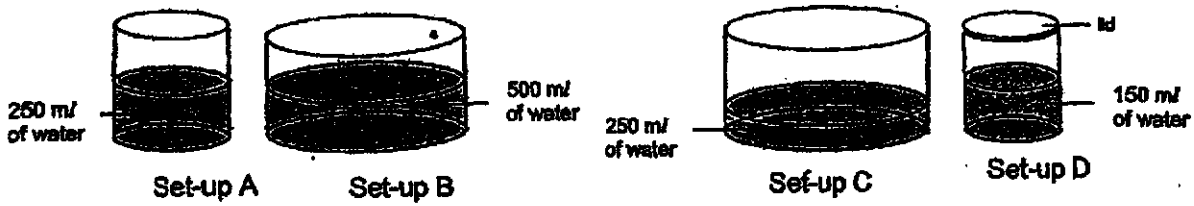

- a) i) Which two set-ups should Shaun use if he wants to find out how the rate of evaporation is affected by exposed surface area of water? [1m]

- ii) Using the same set-up, suggest one way to shorten the duration of the experiment. [1m]

- b). Shaun decided to heat the water in Set-up B and C until the water boiled. He left set-up B and C on the table for 20 minutes and recorded the temperature every two minutes.

The graph below shows how the temperature of water in set-up B and C changed with time.

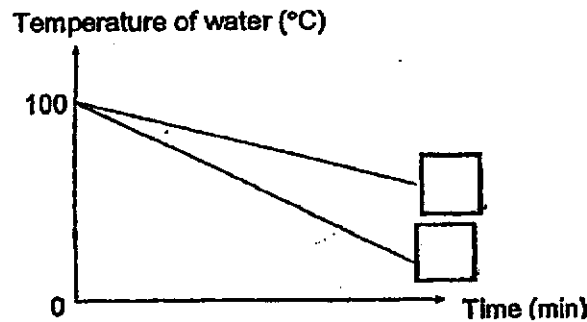

- i) Which line in the graph represents the two set-ups? Fill in the boxes with the letters, B or C. [1m]

- ii) Explain your answer in (i). [2m]

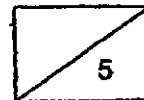

33. Emily placed a glass of ice cubes on a table. The diagrams below show what happened after some time.

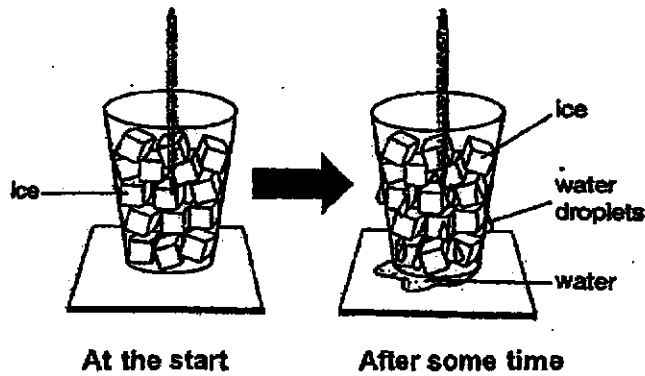

- a) Explain how water droplets appeared on the outer surface of the glass after some time. [2m]

She recorded the temperature shown on the thermometer every two minutes. The graph below shows the change in temperature over time.

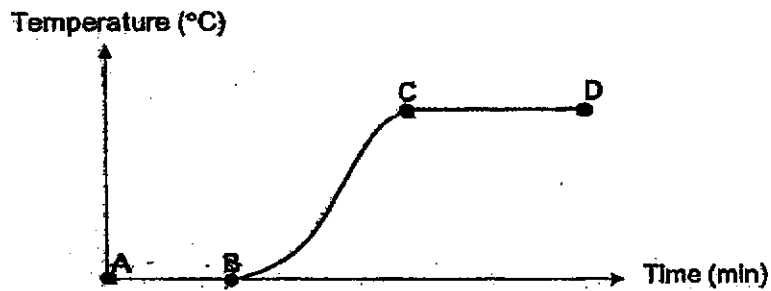

- b) At which point, A, B, C or D, was all the melting completed? [1m]

- c) At which point, A, B, C or D, did the water stop gaining heat? [1m]

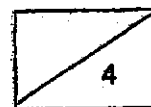

34. Chloe studies the relationship between the wind speed and the distance of seeds dispersed from parent plants A and B. Her results are shown in the graph below.

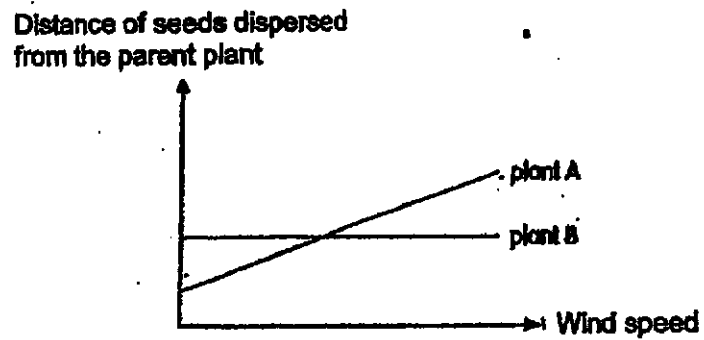

The diagrams below show two different kinds of fruits from plants A and B.

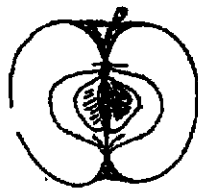

Fruit P



Fruit Q

- a) Which plant, A or B, is Fruit Q most likely from? Explain your answer. [2m]

- b) Chloe spotted two different kinds of flowers, E and F, in her garden.

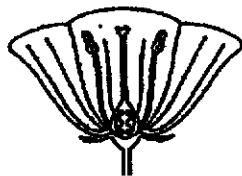

Flower E



Flower F

- Which flower, E or F, was Fruit P most likely developed from? Explain your answer. [1m]

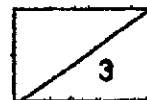

35a. Study Diagrams X and Y below. The diagrams show the movement of two bar magnets after they were brought close together.

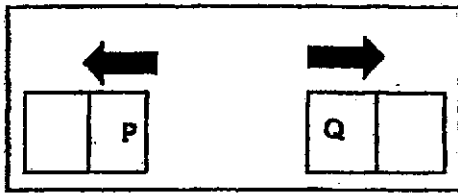

Diagram X

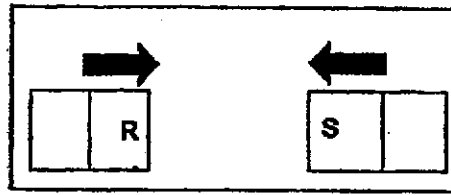

Diagram Y

Write down what poles of Q and S are in the table below.

[1m]

		Poles	
		P	Q
Diagram X	North		

		Poles	
		R	S
Diagram Y	North		

b) A recycling company uses a separator to separate iron from plastic. The diagram below shows the separator.

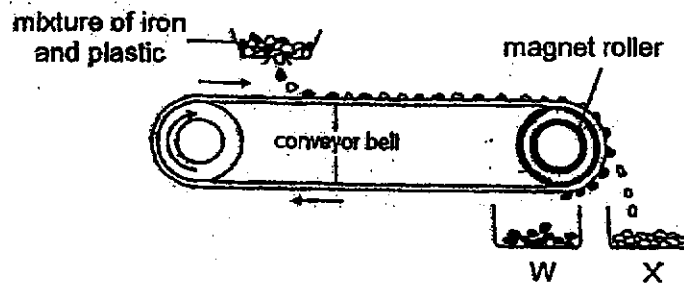

i) Identify the containers which iron and plastic fall into. [1m]

Plastic: _____ Iron: _____

ii) Explain how the iron and plastic are separated. [2m]

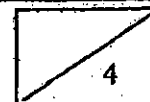

36. Tom wanted to find out how the amount of light affects the rate of photosynthesis in an aquatic plant. He prepared four aquatic plants in four set-ups similar to the one shown below.

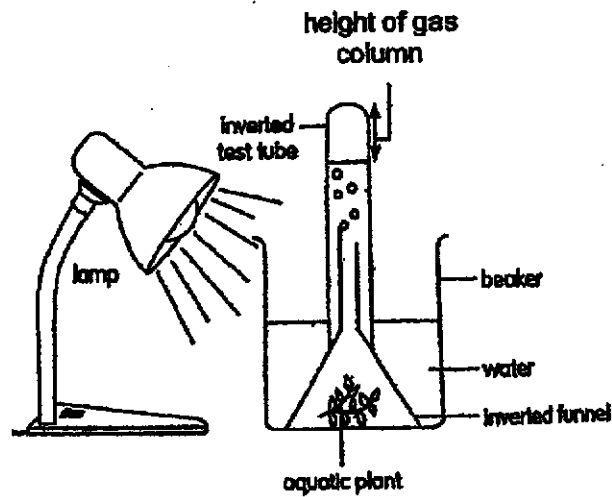

He labelled the set-ups A, B, C and D, and placed the lamp a different distance from the plant for each set-up. The table below shows his observations after some time.

Set-up	Height of gas column in the test tube (cm)
A	0.7
B	2.4
C	1.5
D	4.6

- a) Identify the gas produced by the aquatic plant. [1m]

- b) Based on the results in the table above, which set-up, A, B, C or D had the greatest distance between the lamp and plant? Explain your answer. [2m]

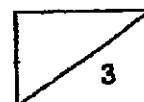

37. The life cycle of a mosquito is shown below.

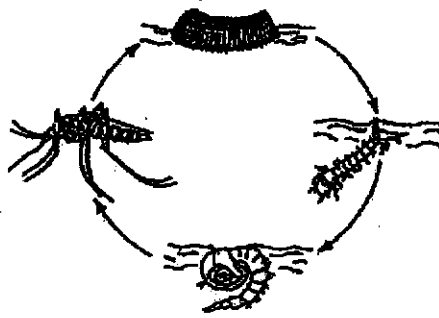

Jennifer studied the duration of three stages in the life cycle of a mosquito and also measured the mass of the mosquito at each of the three stages. Her observations are recorded in the diagrams below.

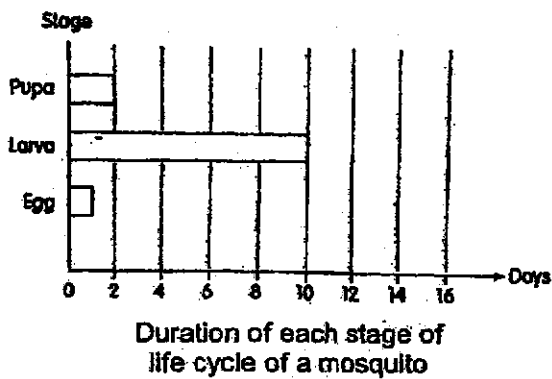

Stage	Increase in mass (units)
X	5
Y	13
Z	35

Change in mass at each stage of life cycle of a mosquito

a) Circle the stage in the life-cycle which matches Z. [1m]

pupa egg larva

Explain your answer. [1m]

b) State the stage in the life-cycle where the mosquito is considered a pest. [1m]

c) How long does it take the mosquito to reach the adult stage after the eggs have hatched? [1m]



38. The diagram below shows the different stages in the life cycle of a plant.

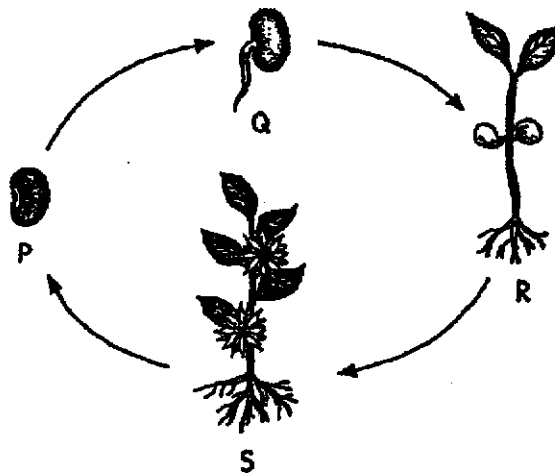

a) At which stage is the plant able to reproduce? [1m]

b) Based on the diagram above, put a tick (✓) in the appropriate column to indicate if each of the following statements is 'True' or 'False'. [2m]

	Statements	True	False
i)	Sunlight is needed at stage Q.		
ii)	Photosynthesis takes place at stages R and S.		
iii)	At stage R, the plant gets food from seed leaves only.		
iv)	Air, water and warmth are needed for the plant to develop from stage P to stage Q.		

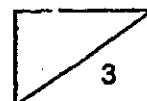

39. Kate sets up an electric circuit, using a battery, a bulb and a switch as shown below.

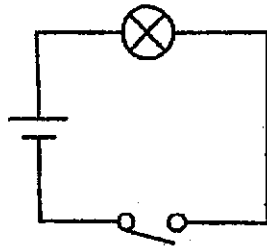

She closed the switch and measured the brightness of the bulb. She repeated this by connecting more light bulbs in series, one at a time. Each time, she measured the brightness of the bulb. The following graph shows her observations.

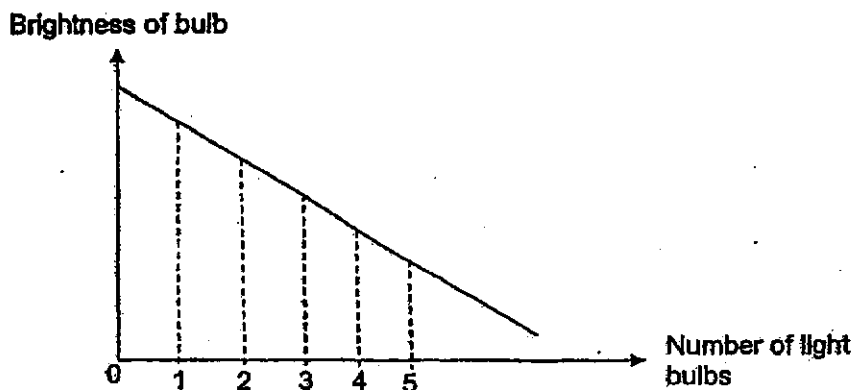

- a) What was the aim of her experiment? [1m]

- b) State the relationship between the brightness of the bulb and the number of light bulbs in the experiment. [1m]

- c) Using the same battery, light bulbs and switch, state how she can arrange for five light bulbs to be as bright as one light bulb. [1m]

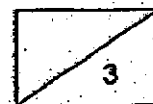

40. Joan wants to conduct an experiment to find out whether a plant absorbs more water when exposed to more light. The diagrams below show the set-ups used to conduct the experiment.

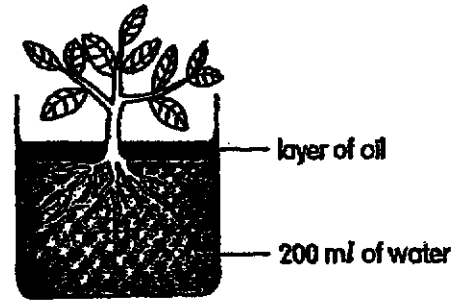
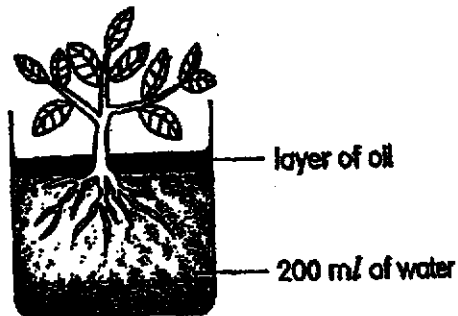

- a) Based on the aim, state the variable which is changed. [1m]

- b) Suggest a reason why a layer of oil was added to both set-ups. [1m]

- c) Explain why Set-up C will have less water than Set-up D after three days. [2m]

END OF PAPER

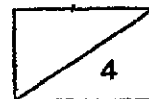

SCHOOL : SCGS PRIMARY SCHOOL
 LEVEL : PRIMARY 5
 SUBJECT : SCIENCE
 TERM : 2019 SA2

Part 1 (60m)

	1	1	2	2	3	2
	2	3	1	4	3	1
	3	3	3	3	2	4
	3	4	4	2	4	
	3	2	2	1	1	

Qn	Suggested Answers
29a	Q is a <u>non-flowering plant</u> and <u>grows in water</u> .
29b	By spores
29c	Rose plant: R Lotus plant: S Bird's nest fern: P Water moss fern: Q
30a	Cell sample A: Plant cell Cell sample B: Animal cell
30b	Cell wall
30c	Cell membrane
31a	So that <u>other sources of light</u> will <u>not affect the results</u> of the experiment. (Please note that 'fair test' is not relevant in this case as a non-dark room still allows a fair test to be conducted)
31b	J
31c	Material L because it <u>reflects the most light</u> so that the road sign can <u>be seen most clearly at night</u> .
32ai	A and C
32aii	Put them in a windier place OR Put them in a hotter room/ put on hot plate/ heat them up OR Put them in room with a lower humidity (‘Light’ is not a factor in evaporation. ‘Near an open window’ is not accepted unless one of the relevant factors in evaporation is related)
32bi	Upper line – B Lower line – C
32bii	As Set-up B had a <u>larger volume of water / more water</u> than C, the water in Set-up B has <u>more heat</u> and thus <u>takes more time to lose heat / lose heat slower</u> than the water in Set-up C (Note that ‘heat’ and ‘temperature’ are not the same as ‘heat’ is energy and ‘temperature’ is a measurement on the degree of how hot something is. Comparison on the heat content due to volume is needed here)
33a	The <u>warmer water vapour from the surrounding air</u> comes into contact with the <u>cooler outer surface of the glass</u> And the water vapour <u>loses heat</u> and <u>condensed</u> into water droplets. (Need to indicate temperature difference between the water vapour and the outer glass surface using the words ‘warmer’, ‘cooler’. They also need to indicate the source of water vapour and which surface the condensation is taking place on)
33b	B
33c	Point C

Qn	Suggested Answers			
34a	Plant A. Fruit Q has a <u>wing-like structure / 'wings'</u> which allows it to be <u>dispersed further from the parent plant when there is more wind.</u>			
34b	Flower E. Flower E has <u>female reproductive part / stigma / ovary</u>			
35a	Q: North S: South			
35b i	Plastic: X Metal: W			
35b ii	<u>Plastic pieces will not be attracted</u> to the magnet roller and will drop off as they move down/reach X. <u>Iron pieces will be attracted to the magnet roller</u> and will remain attracted to the roller till they reach W.			
36a	Oxygen			
36b	<u>A</u> . According to the results, A had the <u>least oxygen produced</u> . A must be furthest away from the lamp as it must have <u>received the least light and had the slowest rate of photosynthesis.</u>			
37a	Circle - <u>larva</u> Explanation - During larva stage, the mosquito <u>eats the most</u> hence the greatest increase in its mass.			
37b	Adult			
37c	12 days (10+2)			
38a	Stage S			
38b		Statements	True	False
	i)	Sunlight is needed at stage Q.		✓
	ii)	Photosynthesis takes place at stages R and S.	✓	
	iii)	At stage R, the plant gets food from seed leaves only.		✓
iv)	Air, water and warmth are needed for the plant to develop from stage P to stage Q.			
39a	To find out how the number of light bulbs in series affect the brightness of the light bulbs.			
39b	When the number of light bulbs increased, the brightness of the bulb decreases. (Need to check sentence for the cause and effect. 'Number of light bulbs' is the cause)			
39c	She can arrange the <u>light bulbs</u> in parallel. (Note that 'light bulbs' must be indicated as other parts of the circuit such as 'batteries' may also be arranged in parallel)			
40a	Amount of light received by plant/ plant is exposed to.			
40b	To ensure that the change/decrease in volume of water is <u>only caused</u> by water loss through the leaves and the roots taking in water / not affected by the evaporation of water from the beaker at all.			
40c	Plant in Set-up C receives more light than plant in Set-up B, so C's plant has a higher rate of photosynthesis which is a process that requires water. As a result, the roots in Set-up C has to take in more water.			