



NAN HUA PRIMARY SCHOOL
END-OF-YEAR EXAMINATION 2024
PRIMARY FIVE

SCIENCE
(BOOKLET A)

Total Time for Booklets A and B: 1 hour 45 minutes

INSTRUCTIONS TO CANDIDATES

1. Write your name, index number and class in the spaces provided below.
2. Do not turn over the page until you are told to do so.
3. Follow all instructions carefully.
4. Answer all questions.
5. Use a 2B pencil to shade your answers on the Optical Answer Sheet (OAS).

Marks Obtained

Booklet A		/ 56
Booklet B		/ 44
Total		/ 100

Name: _____ ()

Form Class: P5 _____

Teaching Group: 5S _____

Date: 22 October 2024

Parent's Signature: _____

This booklet consists of 20 printed pages.

For each question from 1 to 28, four options are given. One of them is the correct answer. Make your choice (1, 2, 3 or 4) and shade your answer on the Optical Answer Sheet.

(56 marks)

1 Which of the following characteristics can be used to group amphibians and mammals?

- (1) number of legs
- (2) presence of wings
- (3) presence of a tail
- (4) type of body covering

2 Study the chart below.

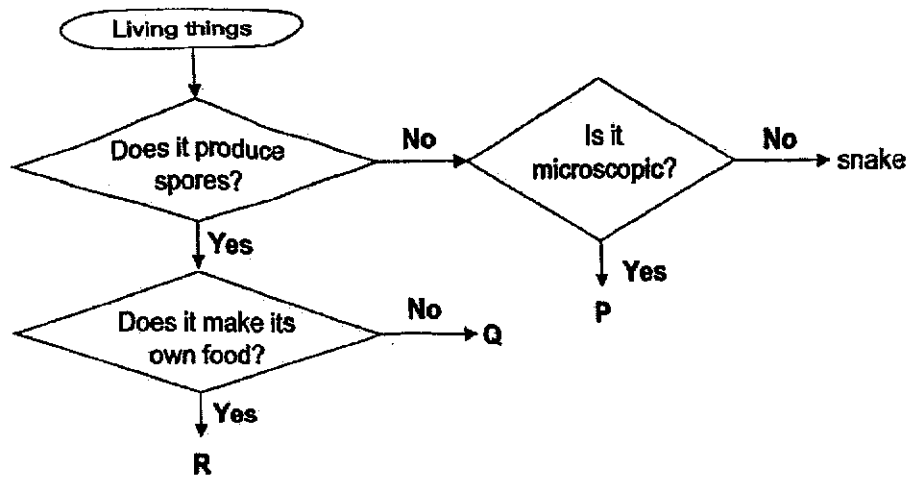

Which of the following is correct?

	P	Q	R
(1)	cat	mushroom	bird's nest fern
(2)	cat	bird's nest fern	mushroom
(3)	bacteria	mushroom	bird's nest fern
(4)	bacteria	bird's nest fern	mushroom

3

- 3 Amanda, Ben, Celine and Dave made the following statements about the roots of a tree.

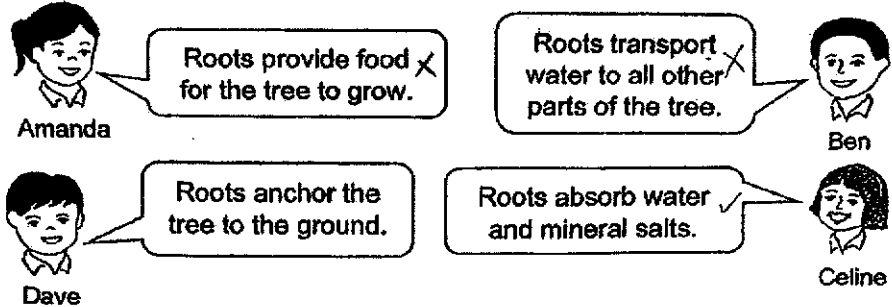

Who made the correct statements?

- (1) Amanda and Ben only
 - (2) Amanda and Celine only
 - (3) Celine and Dave only
 - (4) Ben, Celine and Dave only
- 4 The picture below shows a person cycling.



Which organ systems work together to enable this person to cycle?

- A Skeletal system
 - B Muscular system
 - C Circulatory system
 - D Respiratory system
- (1) A and B only
 - (2) B and C only
 - (3) A, C and D only
 - (4) A, B, C and D

(Go on to the next page)

- 5 The diagram below shows a small ring of a stem removed from a plant. The ring of the stem that was removed contained food-carrying tubes.

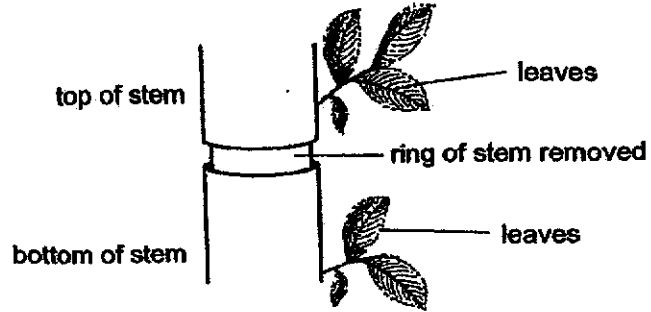

Which of the following shows what the stem will look like after some time?

(1)

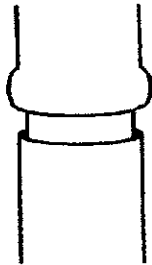

(2)

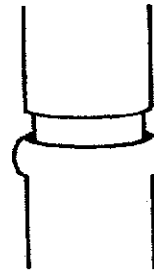

(3)

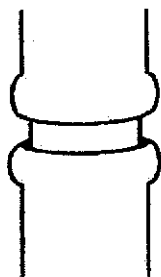

(4)

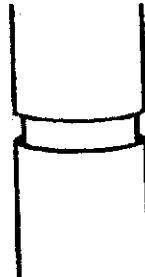

5

- 6 A, B, C, D and E are organs in the digestive system. The graph below shows the amount of undigested food leaving each organ after a meal.

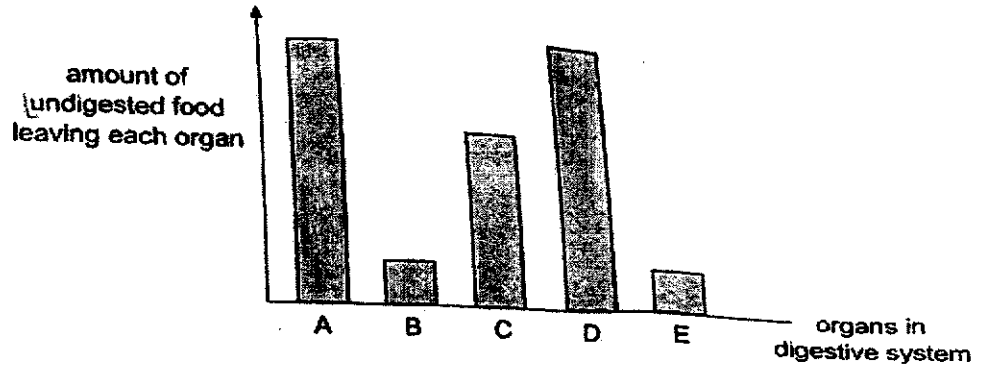

Which of the following is correct?

	Mouth	Gullet	Small Intestine	Large Intestine
(1)	A	D	B	E
(2)	A	D	C	B
(3)	B	C	D	A
(4)	B	E	A	D

(Go on to the next page)

6

7 Five people were trapped in a small lift for 30 minutes. Which of the following graphs best represents the composition of air in the lift at the start and at the end of the 30 minutes?

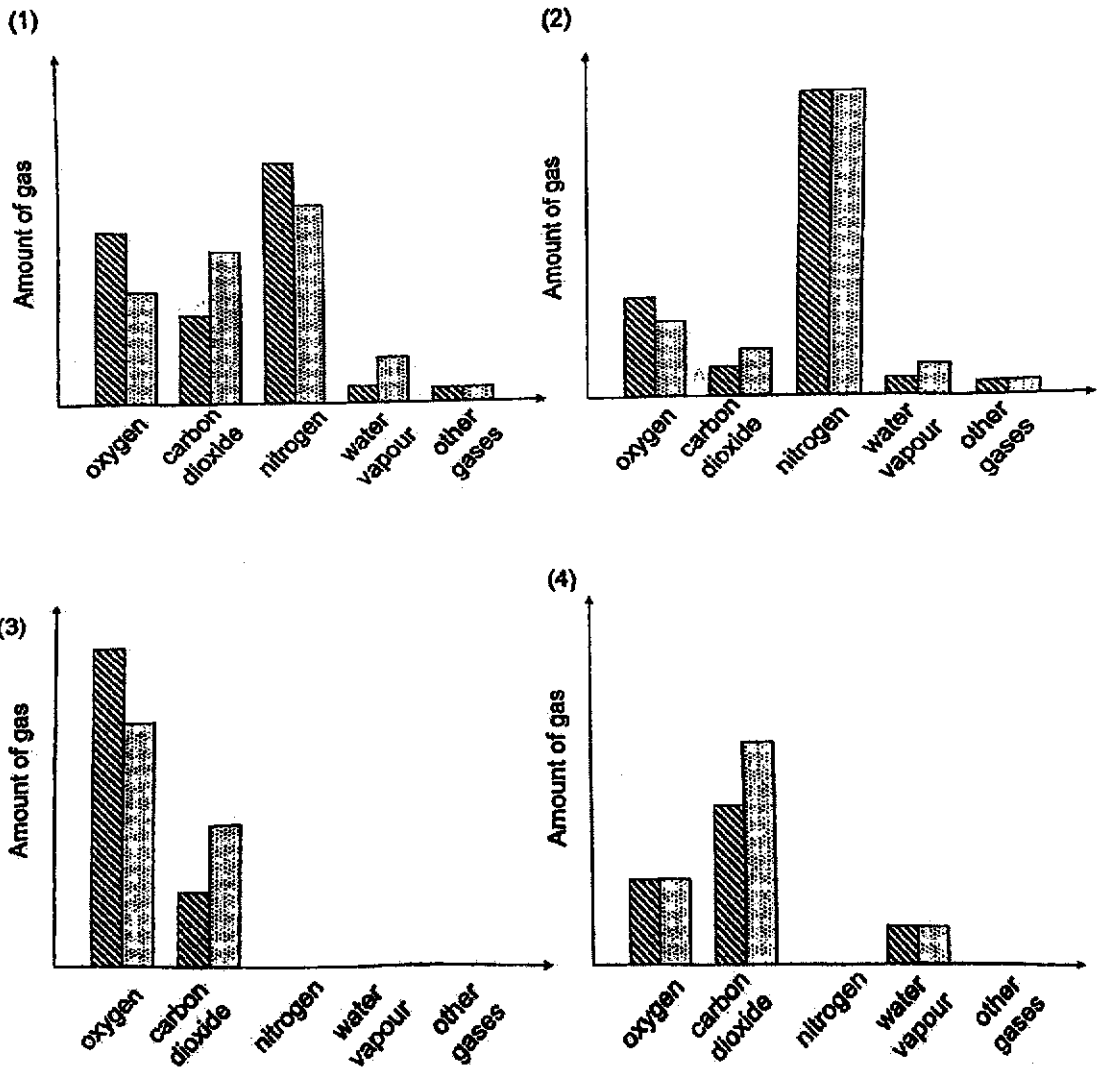
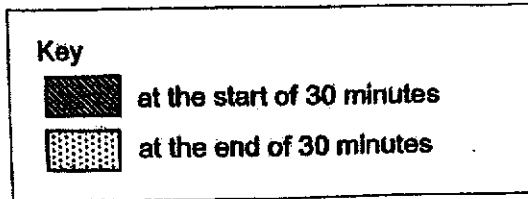

0009/02(A)

7

- 8 The diagram below shows parts of a human system and a fish system. The arrows represent the exchange of gases with the surroundings.

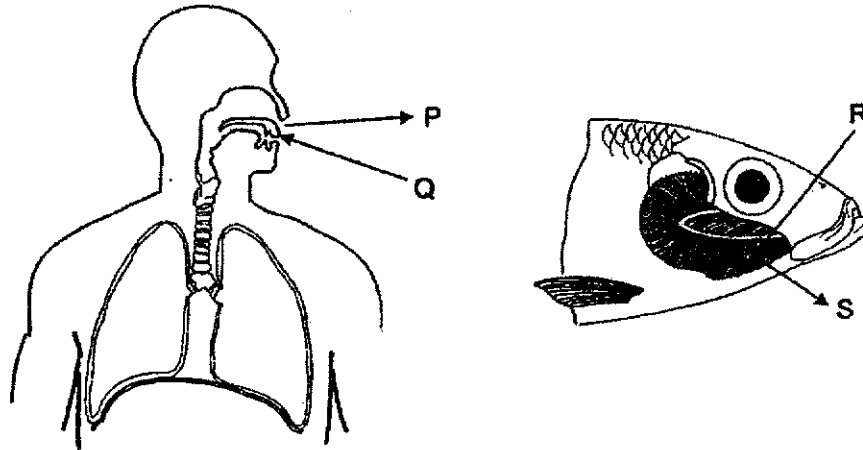

Which arrows show the air/water having more carbon dioxide?

- (1) P and S
 - (2) Q and R
 - (3) P and R
 - (4) Q and S
- 9 Which statement(s) about the cells in our body is/are correct?

- A Each cell is a basic unit of life.
- B A cell is a system made up of several parts.
- C Living things can be made up of one or many cells.

- (1) A only
- (2) B only
- (3) A and B only
- (4) A, B and C

(Go on to the next page)

8

- 10 Tom cut a root into pieces of the same size and placed each piece into a glass container. Each container was kept at a different temperature.

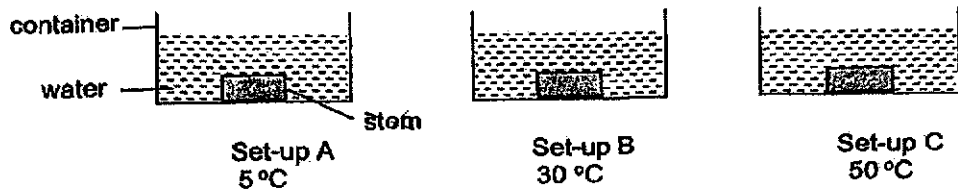

The root contained a red substance.

After an hour, Tom observed and recorded the colour of the water in the containers in the table as shown below.

Set-up	Colour of water
A	light pink
B	pink
C	dark pink

Which of the following explains her observation?

	Temperature change	Effect on root
(1)	decreased	The cell wall prevented more red substance from moving out.
(2)	decreased	The cell membrane allowed more red substance to move out.
(3)	increased	The cell membrane allowed more red substance to move out.
(4)	increased	The cell wall prevented more red substance from moving out.

9

11 The diagram below shows the life cycle of a plant.

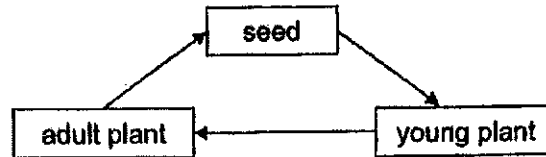

Which one of the statements is not correct?

- (1) A seed cannot make its own food.
- (2) A young plant can make its own food.
- (3) A young plant can bear flowers.
- (4) An adult plant can bear fruits.

12 The graph below shows the mass of food eaten by a butterfly during the different stages, A, B, C and D, of its life cycle.

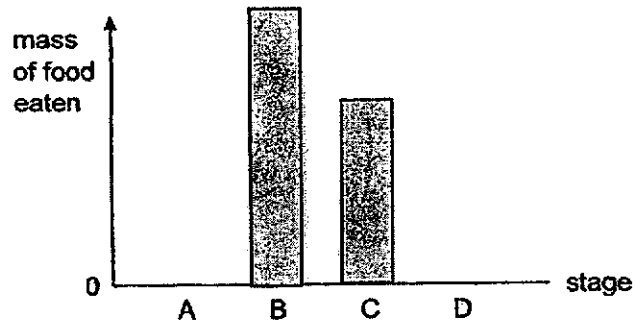

Which of the following is correct?

	A	B	C	D
(1)	pupa	larva	adult	egg
(2)	egg	larva	pupa	adult
(3)	egg	adult	pupa	larva
(4)	adult	pupa	larva	egg

-(Go on to the next page)

13 Which of the following traits can a child inherit from his/her parents?

- A Colour of skin
- B Length of hair
- C Colour of eyes
- D Type of earlobe

- (1) A and C only
- (2) B and D only
- (3) A, C and D only
- (4) A, B, C and D

14 Alan conducted an experiment using two setups, A and B. He placed five seeds in set-up A and left both set-ups in a warm and dark place.

After two days, he observed that the seeds in set-up A germinated and the limewater turned chalky. The limewater in set-up B remained clear.

Limewater turns chalky in the presence of carbon dioxide.

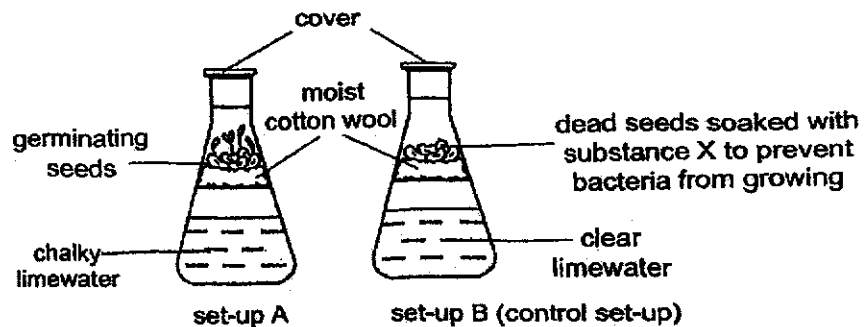

In Alan's experiment, he wanted to find out if seeds _____.

- (1) need carbon dioxide to germinate
- (2) give out carbon dioxide during germination
- (3) need water, oxygen and warmth to germinate
- (4) give out carbon dioxide and water during germination

- 15 David set up an experiment as shown below to compare a property of four planks, W, X, Y and Z, which were made of different materials.

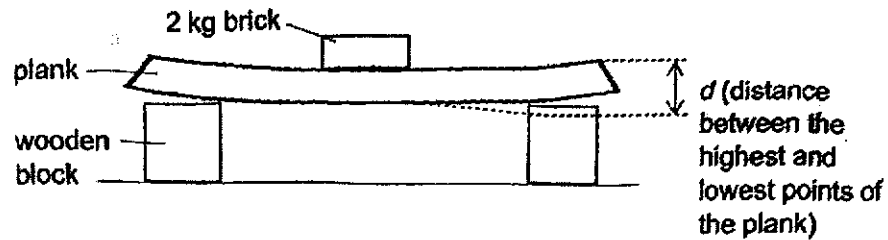

For each plank, she added a 2 kg brick on it and measured the distance d . Her results are shown below.

Plank	W	X	Y	Z
Distance, d (mm)	24	38	10	43

Based on David's experiment, which plank is the most suitable for making a food tray to hold a few plates of food?

- (1) - W
- (2) - X
- (3) - Y
- (4) - Z

(Go on to the next page)

12

- 16 Jacqueline wanted to find out if the colour of a cloth affects its absorbency. She prepared the set-up as shown below.

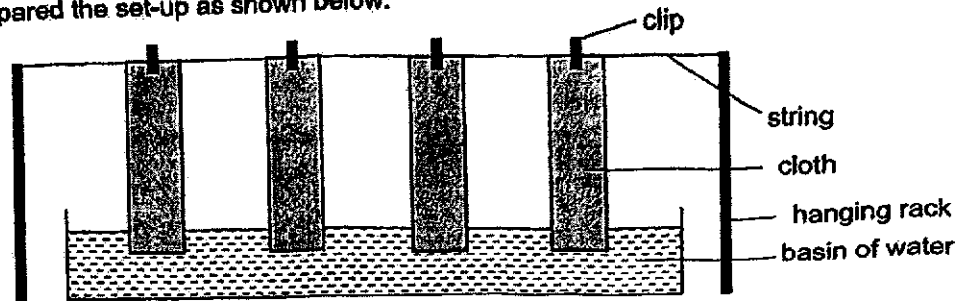

She made a list of variables of this experiment:

- A Colour of cloth
- B Type of fabric of cloth
- C Height from which the cloth is hung
- D Length of the cloth that has absorbed water

Which of the following is correct?

	Variable(s) to change	Variable(s) to keep the same	Variable(s) to be measured
(1)	A	B, C	D
(2)	A, D	B	C
(3)	B	A, C	D
(4)	D	B, C	A

17 Barry made a game using the objects shown below.

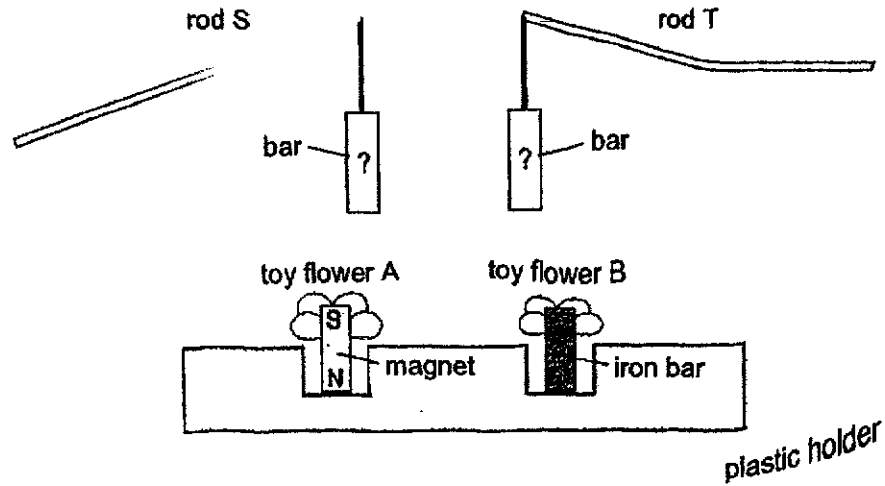

The lower end of the bars was brought near to the toy flowers to pick them up.

Rod S could pick up both toy flowers A and B.
 Rod T could pick up toy flower A only.

Which of the following shows the bars for rods S and T correctly?

- (1) Rod S: S (top), N (bottom); Rod T: N (top), S (bottom)
- (2) Rod S: N (top), S (bottom); Rod T: iron bar (bottom)
- (3) Rod S: S (top), N (bottom); Rod T: iron bar (bottom)
- (4) Rod S: iron bar (bottom); Rod T: N (top), S (bottom)

(Go on to the next page)

- 18 A steel bar AB was magnetised using the "stroke" method as shown in Diagram 1. Diagram 2 shows the magnetic poles of AB after it was magnetised.

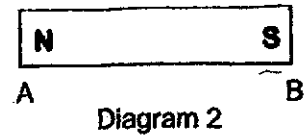
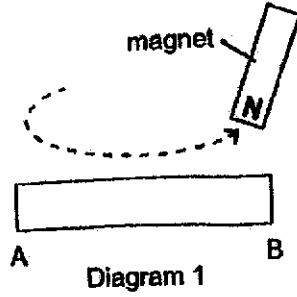

Steel bars CD and EF were magnetised as shown in Diagram 3 and 4.

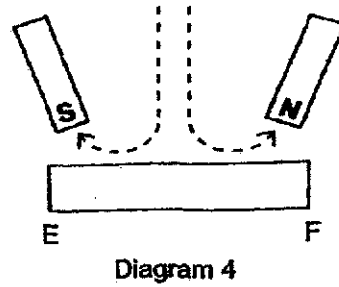
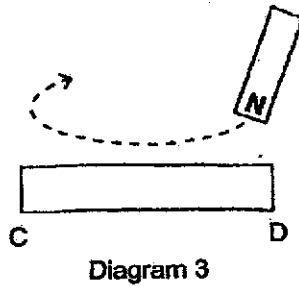

Which of the following shows the magnetic poles of bars CD and EF correctly?

(1)		
(2)		
(3)		
(4)		

19 Which of the following statements is true for all states of matter?

- (1) Matter has mass and definite volume.
- (2) Matter has mass and occupies space.
- (3) Matter occupies space and can be compressed.
- (4) Matter has indefinite shape and indefinite volume.

20 An experiment was set up using a sealed flask which can hold a total of 100 cm^3 of different substances as shown below.

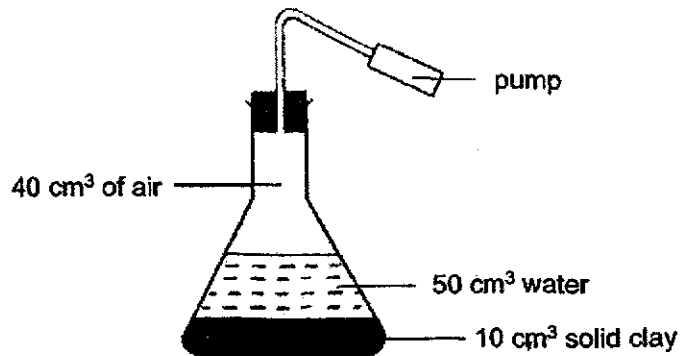

20 cm^3 of air was then pumped into the flask using the pump. What is the final volume of air in the flask?

- (1) 20 cm^3
- (2) 40 cm^3
- (3) 60 cm^3
- (4) 100 cm^3

(Go on to the next page)

- 21 The table below shows the melting and boiling points of three substances, X, Y and Z.

Substance	Melting point (°C)	Boiling point (°C)
X	27	66
Y	41	83
Z	58	95

At which of the following temperatures will the three substances, X, Y and Z, be in the same state of matter?

- (1) 30 °C
 - (2) 50 °C
 - (3) 60 °C
 - (4) 80 °C
- 22 Corrine conducted an experiment to obtain drinking water from seawater.

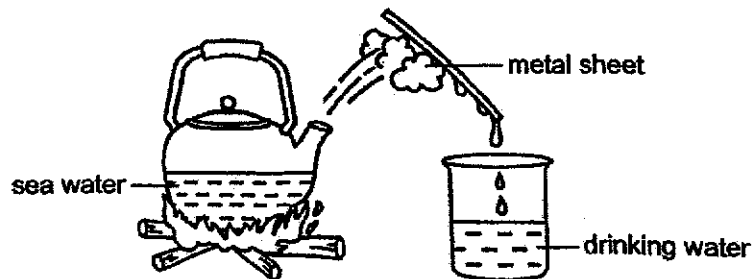

What are the processes involved in Corrine's experiment?

- A Boiling
 - B Melting
 - C Freezing
 - D Condensation
- (1) A and B only
 - (2) A and D only
 - (3) B and D only
 - (4) C and D only

- 23 Nicole left a metal spoon in the fridge. After some time, she took the cold metal spoon out of the fridge and placed it in a bowl of hot food as shown below.

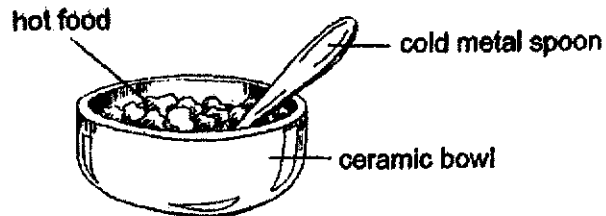

After some time, she touched the handle of the spoon and felt that it was hot. Which of the following statements best explain her observation?

- A The cold metal spoon gained heat from the hot food.
 - B The cold metal spoon lost heat to the surrounding air.
 - C The cold metal spoon lost its coldness to the hot food.
 - D The cold metal spoon gained heat from the ceramic bowl.
- (1) A and C only
(2) A and D only
(3) B and C only
(4) C and D only

(Go on to the next page)

24 Aaron conducted an experiment using the set-up below.

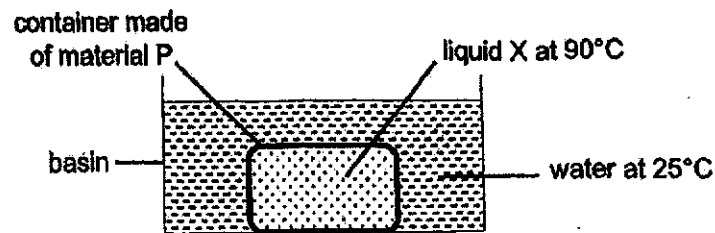

He measured the temperature of liquid X in the container over a period of time.

He repeated the experiment using a container made of material Q. His results are shown in the graph below.

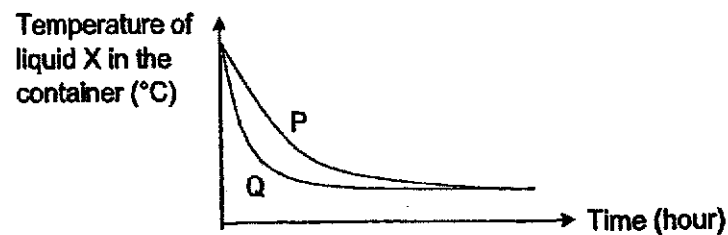

Aaron wanted to bring hot food and cold drinks for an outing. He wanted to keep the food hot and the drinks cold. Which material(s) would be more suitable for the containers?

	Material for container carrying	
	hot food	cold drinks
(1)	P	P
(2)	P	Q
(3)	Q	P
(4)	Q	Q

19

- 25 Jerry was in a dark room. He switched on the lamp shown in Diagram 1. He then placed a lamp shade on the lamp as shown in Diagram 2.

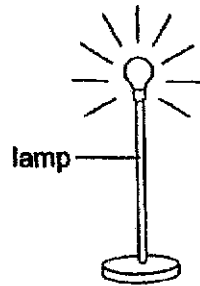

Diagram 1

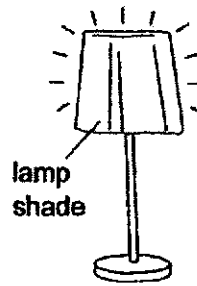
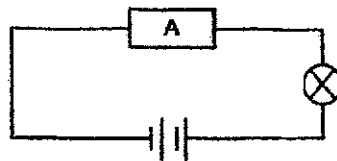

Diagram 2

Which of the following best explains why the room was less bright than before?

- (1) The lamp does not give out enough light.
 - (2) Light cannot pass through the lamp shade.
 - (3) Less light from the lamp enters Jerry's eyes.
 - (4) Less light is reflected from the lamp into Jerry's eyes.
- 26 Study the electric circuit shown below.



Which of the following materials can be used to make object A if we want the bulb to light up?

- (1) iron
- (2) wood
- (3) plastic
- (4) rubber

(Go on to the next page)

- 27 Study the 4 circuit diagrams below. The bulbs and batteries in the 4 circuits are working properly.

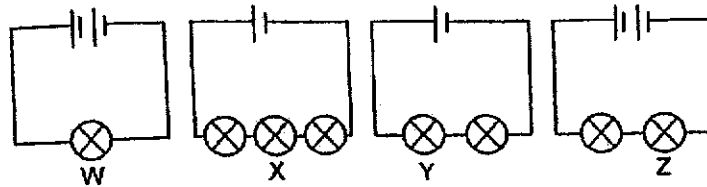

Which one of the following arranges the bulbs, W, X, Y and Z from the brightest to the dimmest?

- (1) W, Z, Y, X
 - (2) W, Y, X, Z
 - (3) X, Y, Z, W
 - (4) Z, W, Y, X
- 28 Study the circuit below. The batteries and bulbs are all working properly.

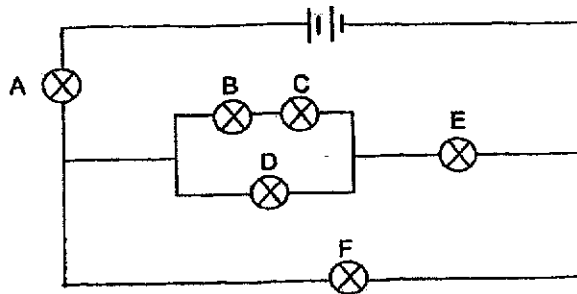

Which of the following correctly states the number of bulb(s) that would still be lit when one or more bulbs are blown?

	Bulb(s) that is/are blown	Number of bulb(s) still lit
(1)	A	1
(2)	C	3
(3)	B and D	2
(4)	E and F	4



NAN HUA PRIMARY SCHOOL
END-OF-YEAR EXAMINATION 2024
PRIMARY FIVE

SCIENCE
(BOOKLET B)

Total Time for Booklets A and B: 1 hour 45 minutes

INSTRUCTIONS TO CANDIDATES

1. Write your name, index number and class in the spaces provided below.
2. Do not turn over the page until you are told to do so.
3. Follow all instructions carefully.
4. Answer all questions.
5. Use dark blue or black ballpoint pen to write your answers in the space provided for each question.
6. Do not use correction fluid/tape or highlighter.

Marks Obtained

Booklet B	/ 44
------------------	------

Name: _____ ()

Form Class: P5 _____

Teaching Group: 5S _____

Date: 22 October 2024

Parent's Signature: _____

This booklet consists of 15 printed pages and 1 blank page.

Write your answers to question 29 to 40, write your answers in this booklet.

The number of marks available is shown in brackets [] at the end of each question or part question.

(44 marks)

29 Kenneth placed a part of a celery in a beaker of blue-coloured water.

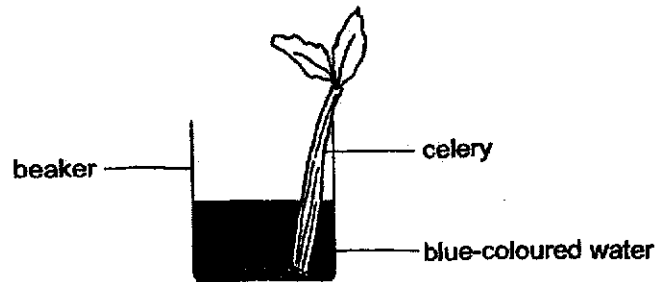

After one day, he cut its stem. A section of the stem is shown in the diagram below. The parts of the stem labelled X were stained blue. The parts of the stem labelled Y were not stained blue.

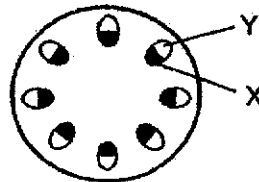

(a) State one of the functions of the stem of a plant. [1]

(b) Explain why part X was stained blue, but part Y was not. [1]

Score	2
-------	---

30 The diagram below shows how food and various gases are transported in the human body.

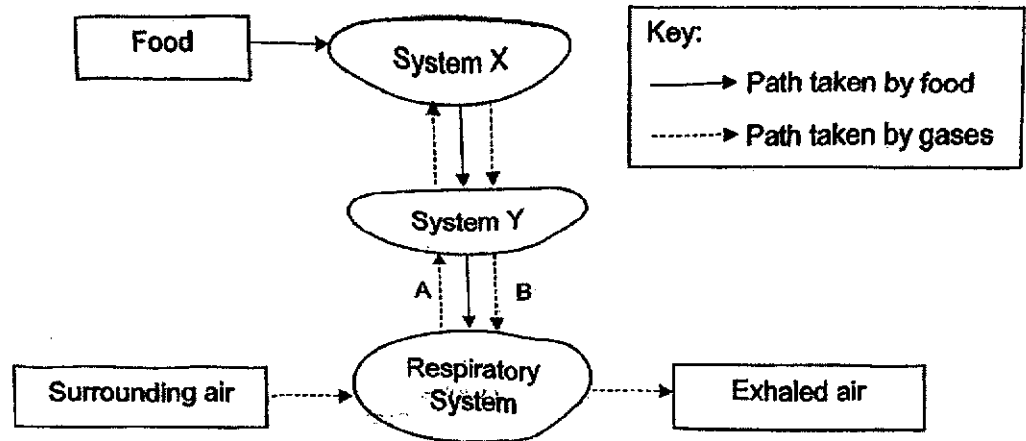

(a) Identify the human systems, X and Y. [1]

System X: _____ System Y: _____

(b) Name the three parts of the human respiratory system. [1]

(c) Explain why blood vessel A transports blood richer in oxygen than blood vessel B. [2]

Score	4
-------	---

(Go on to the next page)

4

- 31 Sarah conducted an experiment to find out how her heart rate changes with different activities. She measured her heart rate immediately after each activity and recorded the results in the table below.

Activity	Heart rate (beats per minute)
resting	64
jogging	130
skipping	120

- (a) How was the heart rate affected when Sarah was jogging compared to when she was resting? [1]

- (b) Explain your answer in part (a). [2]

- (c) To ensure a fair test, suggest one variable regarding the activities that Sarah had to keep the same. [1]

Score	4
-------	---

5

32 The diagram below shows two cells, cell A and cell B.

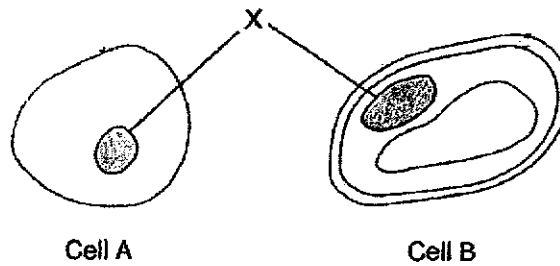

(a) Name part X and state its function. [1]

(b) Based on the diagram above, which cell, A or B, is a plant cell? Give a reason for your answer. [1]

(c) In the diagram above, **label** and **name** on both cells A and B another part that can be found in both cells. [1]

(d) Give a reason why it is important for organisms to produce new cells. [1]

Score	4
-------	---

(Go on to the next page)

33 Study the table below. Kate wanted to find out the effect of overcrowding on the growth of plant Q.

Pot	Size of pot	Number of seeds of plant Q
A	large	20
B	large	15
C	large	20
D	medium	15
E	small	15

(a) Which three pots must Kate choose to ensure a fair test? [1]

(b) After a week, the seeds of plant Q germinated. Study the diagram below and put a tick in the correct box to identify the seedling of plant Q that was most likely taken from the pot that was not overcrowded. [1]

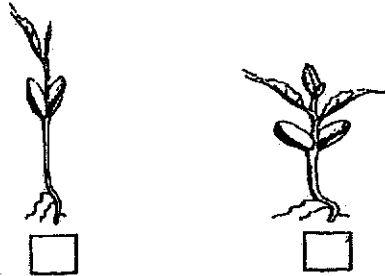

(c) Explain your answer in part (b). [2]

Score	4
-------	---

7

34 The diagram below shows a process that takes place in a female human body.

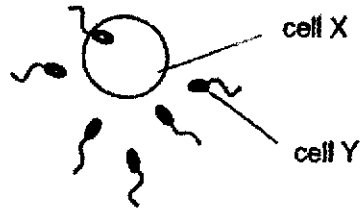

(a) Name the process shown in the diagram above. [1]

(b) Name the part of the human body that produces: [1]

(i) cell X: _____

(ii) cell Y: _____

(c) Give a reason why it is important for the male reproductive organ to produce many cell Y. [1]

Score	3
-------	---

(Go on to the next page)

35 Kevin prepared two set-ups as shown below to magnetise two similar iron rods.

20 coils of wire around the iron rod

10 coils of wire around the iron rod

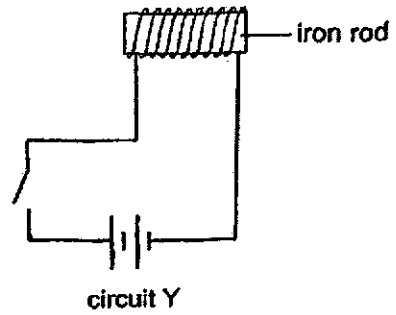
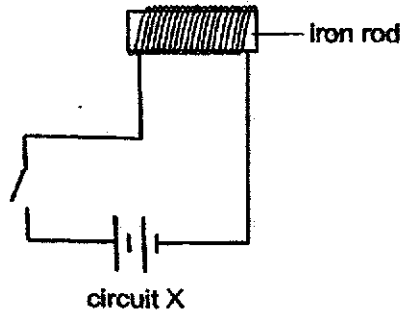

(a) State the property that makes iron a suitable material to be used in the set-ups above. [1]

(b) Kevin brought a bar magnet towards one end of the iron rod in circuit X. What must he observe to conclude that the iron rod has become an electromagnet? [1]

(c) Kevin placed a tray of steel clips near the iron rods of circuits X and Y. He counted the number of steel clips attracted by the magnetised iron rods. What was the aim of his experiment? [1]

Score	3
-------	---

9

- 36 Joe set up a glass bottle garden as shown below. After some time, he observed some water droplets on the inner side of the clear glass bottle and cover.

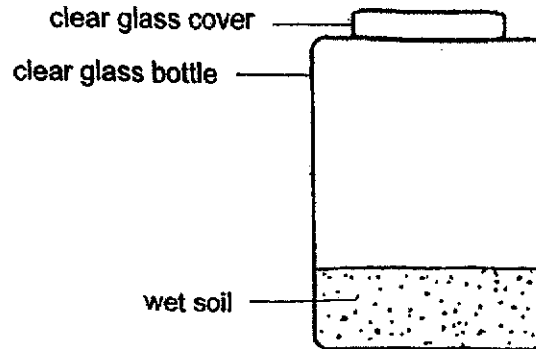

- (a) Explain how the water droplets were formed. [2]

- (b) (i) Joe removed the clear glass cover and observed that the water droplets disappeared. Give a reason for your answer. [1]

- (ii) Name one factor that affects how fast the water droplets disappear [1]

Score	4
-------	---

(Go on to the next page)

- 37 A piece of cotton wool was placed at the base of a plastic cup, as shown in the diagram below.

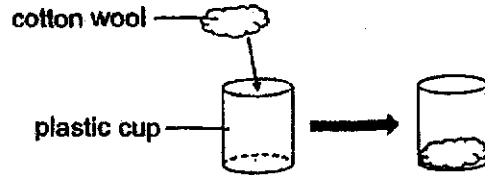

This plastic cup containing the cotton wool was overturned, and put into a container of water, as shown in the diagram below.

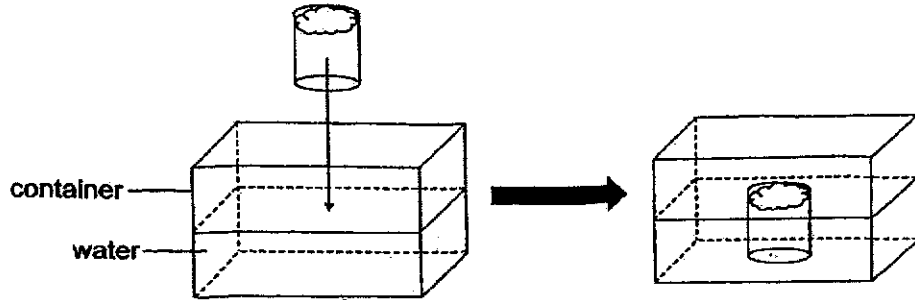

- (a) Although water entered the plastic cup, the cotton wool in the plastic cup did not get wet. Explain why. [1]

- (b) A hole was made at the bottom of the plastic cup, and the same steps were carried out as before. Explain why the cotton wool got wet. [2]

Score	3
-------	---

11

- 38 400 cm³ of boiling water and 200 cm³ of boiling water were poured into 2 identical containers, D and E respectively. The containers were then left at room temperature.

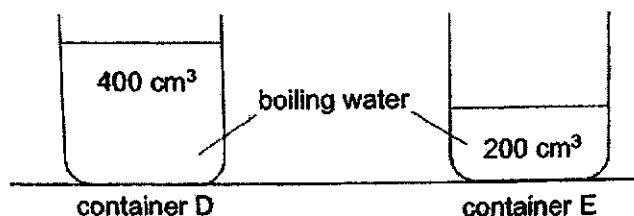

The temperatures of water in containers D and E were recorded over a few hours.

- (a) State the boiling point of water. [1]

- (b) There are some statements in the table below.
Put a tick (✓) in the box to indicate if the statement is true or false. [2]

Statement	True	False
At the start of the experiment, the water in containers D and E had the same amount of heat.		
At the start of the experiment, the water in containers D and E had the same temperature.		
The air surrounding the containers would gain heat from the hot water in containers D and E.		
After a few hours, the water in D and E would reach room temperature.		

(Go on to the next page)

- (c) Some men were building a road. Eddy suggested that they should add a gap in between the sections of the road, as shown in the diagram below.

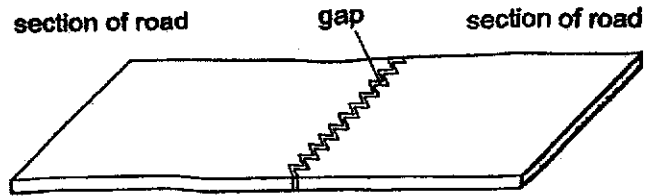

Explain how this gap will be useful for the road on a hot day. [2]

Score	5
-------	---

- 39 Mr Tan has two rooms in his house. He wants to switch on each bulb individually in each room only when needed.

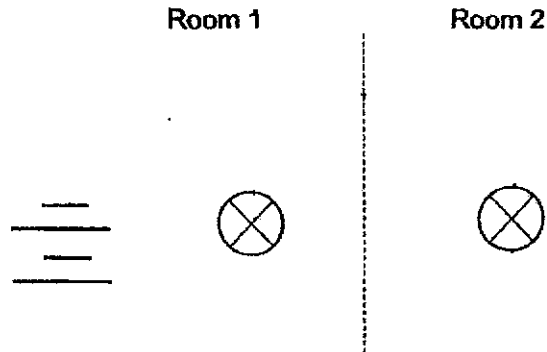

- (a) Complete the circuit diagram above using wires and two switches to suit Mr Tan's requirements. [2]

- (b) Would the arrangement of the switches help Mr Tan to conserve electricity? Give a reason for your answer. [1]

- (c) What is another advantage of connecting the bulbs in the house in this arrangement? [1]

Score	4
-------	---

(Go on to the next page)

- 40 The set-up below shows light shining on three objects, A, B and C, that are made of different materials and are of different shapes. They are placed at different distances from the torch.

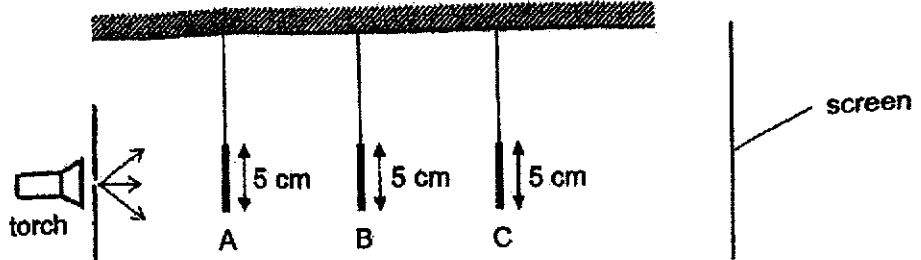

These are the shapes of the objects:

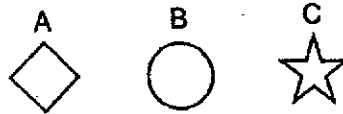

Diagram 1 below shows the shadows of the objects on the screen.

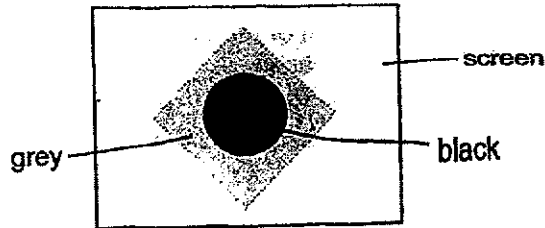

Diagram 1

- (a) With reference to Diagram 1, describe how the shadows were formed. [1]

- (b) Write the letters A, B and C in the table below to indicate the type of materials the three objects could be made of. [1]

Materials		
glass	metal	tracing paper

15

The positions of objects A and C are switched. Diagram 2 below shows the shadow formed on the screen.

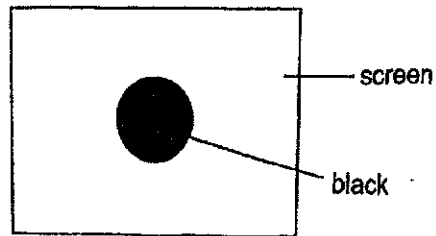

Diagram 2

- (c) (i) Explain why the shadow of object C is not seen on the screen. [1]

- (ii) Explain why the grey shadow is no longer seen on the screen. [1]

End of Paper

Score	4
-------	---

(Go on to the next page)

0009/02(B)

**EYE 2024
PRIMARY FIVE
SCIENCE
Answer Key**

Section A

Question	Answer	Question	Answer	Question	Answer
1	4	11	3	21	3
2	3	12	1	22	2
3	3	13	3	23	2
4	4	14	2	24	1
5	3	15	3	25	3
6	1	16	1	26	1
7	2	17	3	27	1
8	1	18	1	28	3
9	4	19	2		
10	3	20	2		

Section B

Qn	Answer
29a	Possible answers: <ul style="list-style-type: none"> • Supports the plant • Keeps the plant upright • Holds the leaves up • Transports substances around the plant
29b	Part X contains water-carrying tubes that transported the blue-coloured water up the stem, but Part Y does not (have water-carrying tubes / has food-carrying tubes).
30a	X: digestive (system) Y: circulatory (system)
30b	Nose, windpipe and lungs

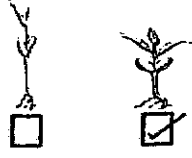
30c	The blood in A came from the lungs here is just absorbed oxygen but the blood in B came from the rest of the body where most of the oxygen are used by the various body parts.
31a	The heart rate increased.
31b	More energy is needed and the heart needs to pump more blood / heart needs to pump faster to transport more oxygen and digested food to the rest of the body and remove more carbon dioxide/waste materials away from the body.
31c	The duration of each/the activity. / Temperature of location
32a	The nucleus controls all activities in the cell / contains hereditary information.
32b	Cell B. It has a cell wall but A does not.
32c	Correct name: cytoplasm or cell membrane Correct labelling of the named part
32d	To replace old/damaged cells./To enable the organism to grow
33a	B, D and E
33b	
33c	The seedling has thicker stem / more leaves / shorter and thicker stem as it does not need to compete for light, space, water and nutrients/minerals (any 3 of the 4 factors)
34a	Fertilisation
34b	Ovary Testis

34c	More of cell Y will increase the chances of fertilisation.
35a	Iron is a magnetic material
35b	It should repel one of the poles/ends of the (bar) magnet.
35c	To find out if/how the number of coils of wire around the iron rod affects the number of steel clips it can attract / its magnetism / magnetic strength.
36a	The water from the soil evaporates (to water vapour). When the water vapour touches the cooler inner surface of the bottle, it will lose heat and condense (into water droplets).
36bi	The water droplets gained heat from the surroundings and evaporated into water vapour.
36bii	Possible answers: <ul style="list-style-type: none"> • Temperature (of the surroundings) • (Presence/Amount/Speed of) Wind
37a	Air in the plastic cup occupies space so the water cannot fill up the cup completely.
37b	Air can escape/leave through the hole in the plastic cup. Water can occupy / take up the space previously occupied / taken up by the air and fill the cup completely, making the cotton wool wet.
38a	100°C
38b	False, True, True, True
38c	<u>Point 1: Expansion</u> On a hot day, the sections of the road will gain heat from the surroundings and expand. <u>Point 2: Explain the gap</u> Possible answers: <ul style="list-style-type: none"> • If there are no gaps, the sections of the road will push/buckle/crack against each other / overlap / cross over / go over / break. • The gaps provide space for the sections to expand.

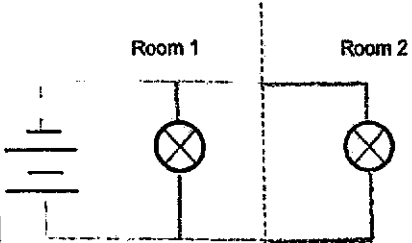
39a	 <p>The diagram shows a battery on the left connected to two parallel branches. The first branch, labeled 'Room 1', contains a light bulb. The second branch, labeled 'Room 2', also contains a light bulb. A vertical dashed line separates the two rooms.</p>
39b	Yes, Mr Tan will use less electricity* as he can switch on each bulb individually/independently/one at a time
39c	When one bulb fuses, the other bulb can still work.
40a	A shadow is formed when light is partially or completely blocked by an object.
40b	C, B, A
40ci	Object C is transparent / does not block light from passing through / allows most light to pass through (so it does not form a shadow).
40cii	Object A is further from the torch / closer to the screen so it forms a smaller shadow than the black shadow / that is blocked by the black shadow .