



RED SWASTIKA SCHOOL

SCIENCE 2024 END-OF-YEAR EXAMINATION PRIMARY 5

Name : _____ ()

Class : Primary 5/ _____

Date : 21 Oct 2024

BOOKLET A

Total time for Booklets A & B: 1h 45 min

Booklet A: 28 questions (56 marks)

Note:

1. Do not open the booklet until you are told to do so.
2. Read carefully the instructions given at the beginning of each part of the booklet.
3. Do not waste time. If the question is too difficult for you, go on to the next question.
4. Check your answers thoroughly and make sure you attempt every question.
5. In this booklet, you should have the following:
 - a. Page 1 to Page 21
 - b. Questions 1 to 28

For Questions 1 to 28, choose the most suitable answer and shade its number in the OAS provided.

1. Which of the following characteristics can be used to differentiate between amphibians and reptiles?
 - (1) where they live
 - (2) the way they move
 - (3) outer body covering
 - (4) method of reproduction

2. Study the chart on classification of organisms.

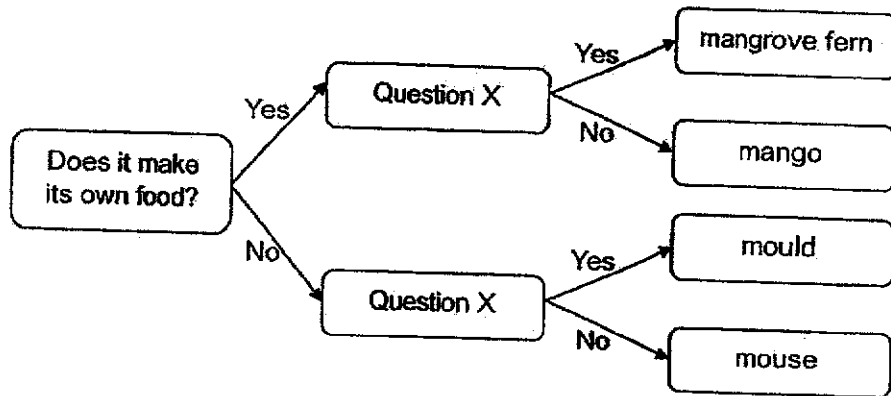

Which of the following is possible for Question X?

- (1) Is it edible?
- (2) Is it harmful?
- (3) Does it reproduce by seeds?
- (4) Does it reproduce by spores?

3. Albert placed open container A and B in a dark room. Each container contains an equal number of worms.

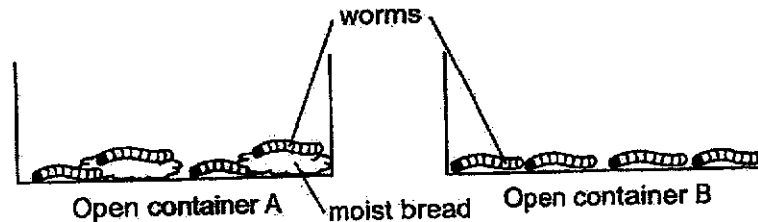

Over a duration of a few weeks, he recorded the number of dead worms in each container daily.

What is the hypothesis tested in this experiment?

- (1) The worms can **only** survive in the dark.
 - (2) The worms need **food** and water to survive.
 - (3) The worms need **air**, food and water to survive.
 - (4) The worms will **not** grow well when there is overcrowding.
4. Mdm Fong's student wrote some statements about humans, fish and plants. Which statement(s) is/are correct?
- A Plants transport food and water in the same tube.
 - B Gaseous exchange occurs at the nose, gills and stomata.
 - C Oxygen and carbon dioxide are transported by the blood in humans and fish.
 - D Humans, fish and plants only take in oxygen and give out carbon dioxide.
- (1) A only
 - (2) C only
 - (3) B and C only
 - (4) B, C and D
5. Which of the following shows the basic unit of life in humans and plants?

	Humans	Plants
(1)	cell	cell
(2)	nucleus	nucleus
(3)	cell	chloroplast
(4)	nucleus	chloroplast

6. Boyle conducted an experiment using the set-up shown below.

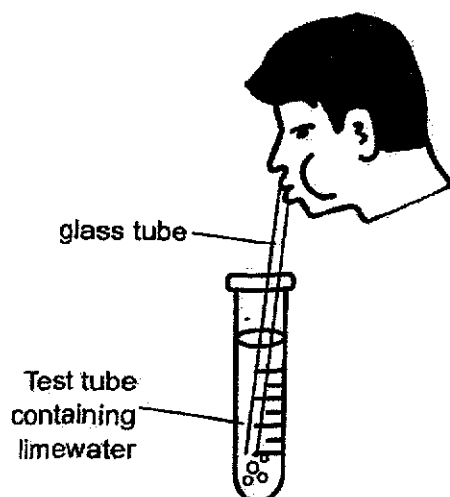

Procedure:

1. Pour freshly prepared limewater into a test tube.
2. Using a glass tube, blow air into the test tube.
3. Check if limewater turns cloudy.

Limewater turns cloudy in the presence of carbon dioxide.

What is the aim of Boyle's experiment?

- (1) To find out if oxygen is present in the air that we breathe in.
- (2) To find out if oxygen is present in the air that we breathe out.
- (3) To find out if carbon dioxide is present in the air that we breathe in.
- (4) To find out if carbon dioxide is present in the air that we breathe out.

7. Charlize removed a ring of tissue on the stem between points A and B. Only food-carrying tubes are removed.

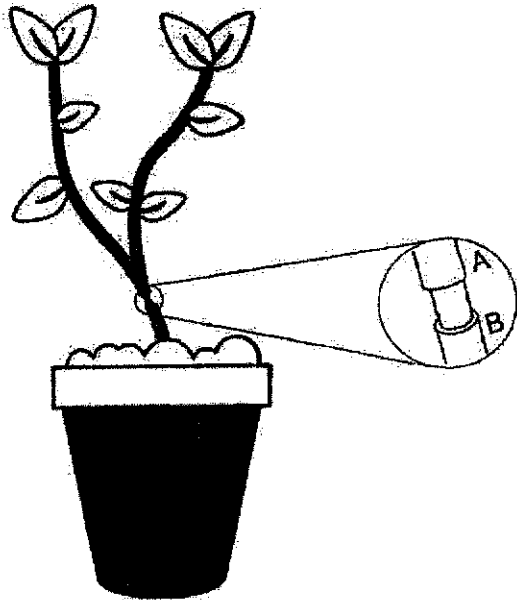

Which diagram shows what Charlize would observe after a few days?

(1)

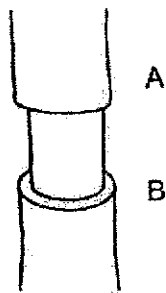

(2)

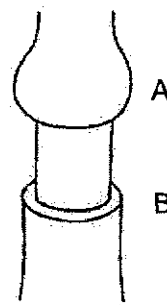

(3)

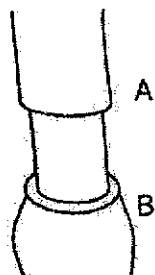

(4)

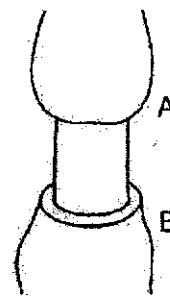

8. The arrows show the movement of a substance within the plant transport system.

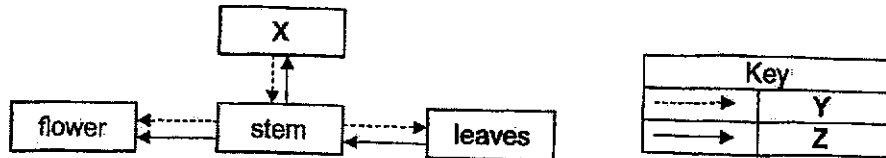

Which of the following best represents X, Y and Z?

	X	Y	Z
(1)	roots	sugar	mineral salts
(2)	fruit	sugar	mineral salts
(3)	roots	mineral salts	sugar
(4)	fruit	mineral salts	sugar

9. Bose made three statements about sexual reproduction in flowering plants and humans.

- A Fertilisation involves the fusion of sperm and egg.
- B Reproductive cells are produced in the ovaries.
- C Fertilisation occurs in the female reproductive part.

Which of the following is correct about flowering plants and humans?

	Flowering plants	Humans
(1)	A and B	A and B
(2)	B and C	A and C
(3)	A, B and C	A, B and C
(4)	B and C	A, B and C

10. The diagram shows the seedling of a flowering plant.

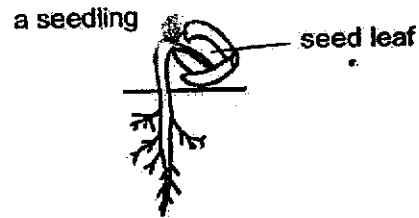

Which of the following graphs is correct?

(1)

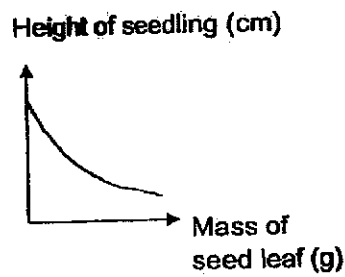

(2)

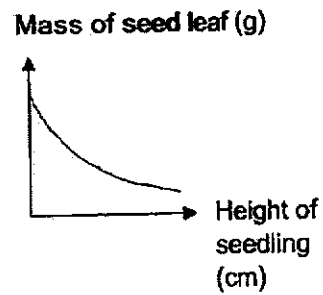

(3)

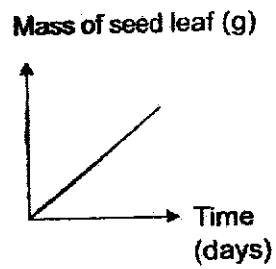

(4)

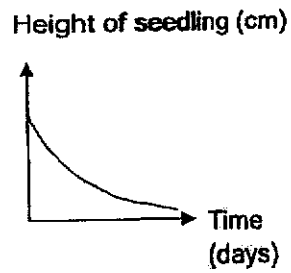

11. The table shows some of the physical characteristics of Marie's family members.

	Earlobe	Eyelid	Face	Hair
Marie's father	detached	single	dimple	short
Marie's mother	attached	double	no dimple	long
Marie's brother	detached	single	dimple	short
Marie's sister	attached	single	no dimple	short
Marie	detached	single	dimple	short

Based on the table, which of the following statements is/are true?

- A Marie inherited her detached earlobe from her brother
 B Marie did not inherit any characteristics from her mother.
 C Marie's sister inherited two characteristics from each parent.
- (1) B only
 (2) C only
 (3) A and B only
 (4) B and C only

- 12 Chandra performed an experiment to find out the conditions necessary for seed germination. She prepared 4 set-ups, A, B, C and D. Each set-up contained 10 seeds placed on a petri dish. Each set-up had different conditions.

Her observations after a few days are shown in the table below:

Set-up	Number of seeds with visible roots
A	0
B	0
C	10
D	10

The table below shows the conditions of each set-up.

Set-up	Conditions present (✓)		
	P	Q	R
A		✓	✓
B	✓	✓	
C	✓		✓
D	✓	✓	✓

Which of the following correctly represents P, Q and R?

	P	Q	R
(1)	Warmth	Oxygen	Water
(2)	Warmth	Water	Oxygen
(3)	Warmth	Light	Water
(4)	Warmth	Water	Light

13. The diagrams below show three electrical circuits which consists of identical components like wires, two batteries and one bulb.

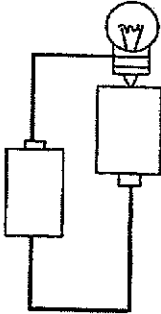

A

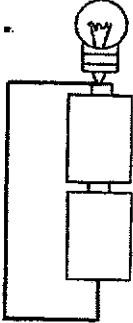

B

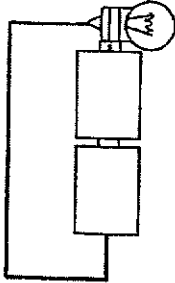

C

In which of the following circuits will the bulb light up?

- (1) A only
- (2) A and C only
- (3) B and C only
- (4) A, B and C

14. Zulman set up an electrical circuit as shown below.

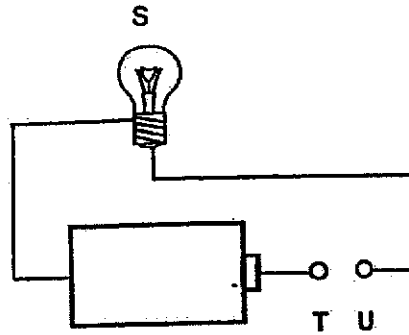

He connected each of the following at points T and U.

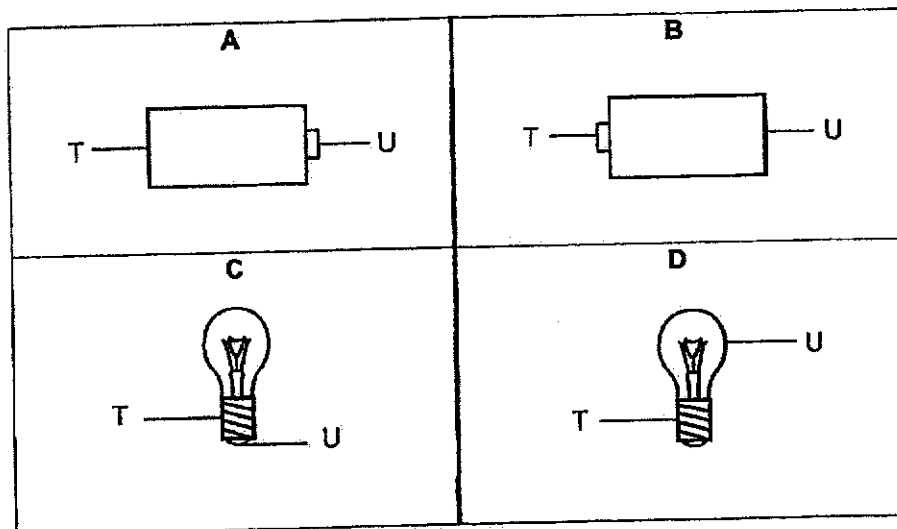

Which of the following will cause bulb S to light up when it is placed between T and U?

- (1) A and C only
- (2) B and C only
- (3) B and D only
- (4) A, C and D only

15. Delia bought a battery-operated toy truck as shown below.

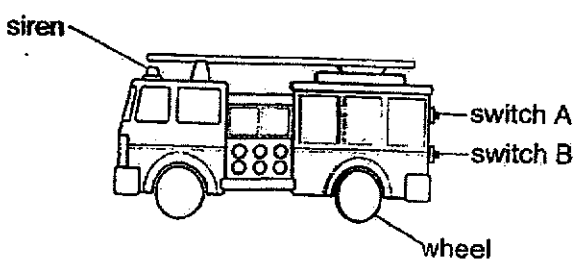

She turned on the switches and recorded the results in the table below.

Switch	Wheels	Siren
A only	Started to spin	
B only		Sounded
A and B	Started to spin	Sounded

Which of the following correctly shows the circuit arrangement in the toy truck?

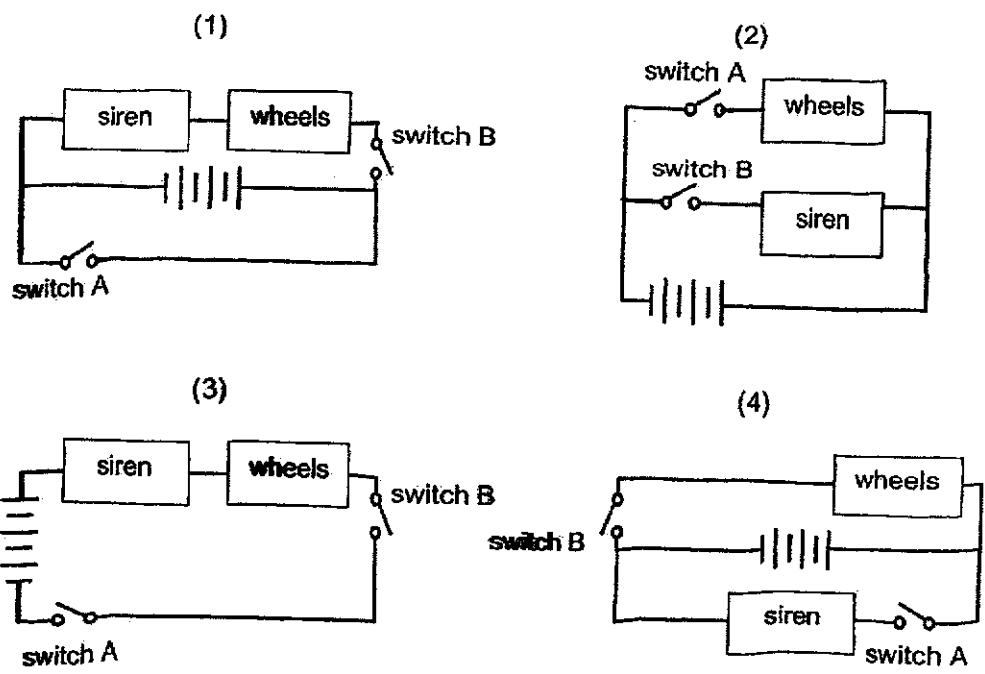

16. Chloe set up an electrical circuit with four identical bulbs and different materials, Y and Z, as shown below.

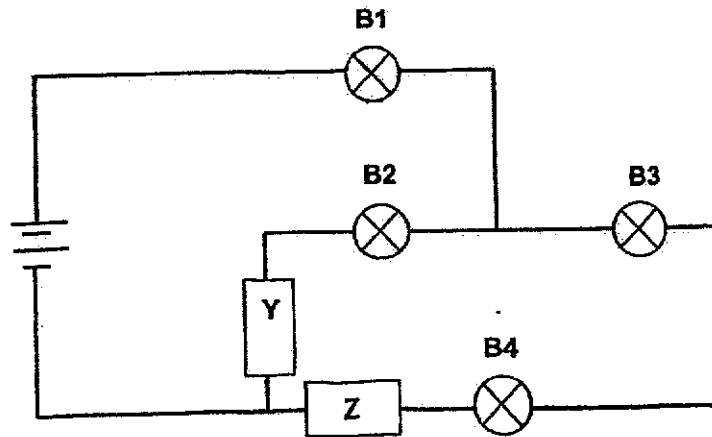



She observed that only B1 and B2 lighted up.

Which of the following correctly identifies materials Y and Z?

	Material Y	Material Z
(1)	aluminium	copper
(2)	plastic	wood
(3)	aluminium	rubber
(4)	wood	copper

17. Mrs Lim measured the mass and volume of three balls which were made of different materials. Her measurements were recorded in the table below.

Ball	Mass (g)	Volume (ml)
 E	250	60
 F	250	120
 G	200	240

Based on her measurements, which of the following conclusions is correct?

- (1) Objects of different sizes can have the same mass.
 - (2) A smaller object occupies more space than a bigger object.
 - (3) Objects of different sizes occupy the same amount of space.
 - (4) An object that occupies more space has a bigger mass than an object that occupies less space.
18. The diagram below shows processes X, Y and Z taking place in the water cycle.

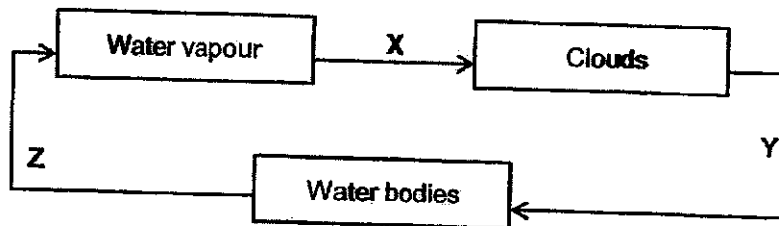

In which of the following process(es) does a change in the state of water take place?

- (1) X only
- (2) Y only
- (3) X and Z only
- (4) X, Y and Z

19. Two syringes, X and Y, contained substances E and F. Plunger in syringe X could not be pushed in while plunger in syringe Y could be pushed in slightly.

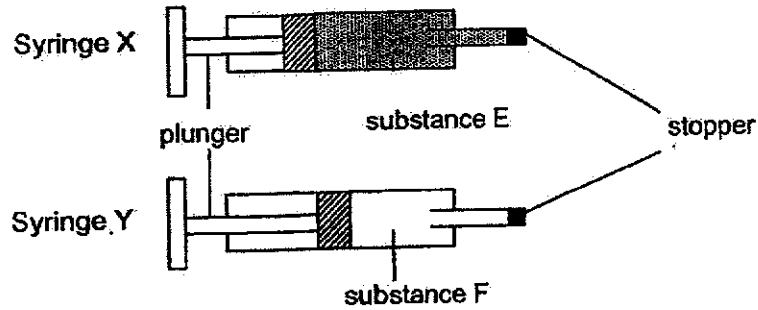

Which of the following statements explain the observations?

- A: Substance E has definite volume.
 B: Both substances E and F have mass.
 C: Substance F can be compressed but not E.

- (1) C only
 (2) A and B only
 (3) A and C only
 (4) B and C only

20. A beaker was filled with water at a temperature of 28°C . It was heated to boiling point for a few minutes before being put into a freezer. The graph below shows the change in the temperature of the water.

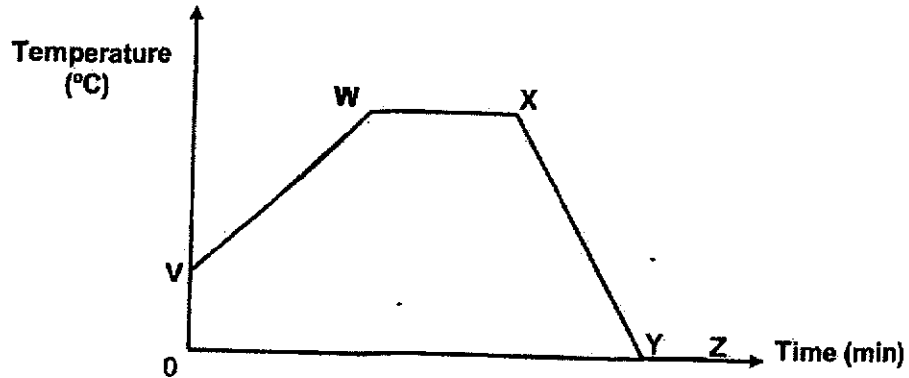

Which of the following processes are correctly matched to the various points on the graph?

	Point	Process	Point	Process
(1)	V to W	evaporation	X to Y	boiling
(2)	V to W	melting	X to Y	evaporation
(3)	W to X	boiling	Y to Z	melting
(4)	W to X	boiling	Y to Z	freezing

21. Samuel placed a wet towel on his grandfather's forehead when he had high fever. The temperature of the bedroom was 30°C .

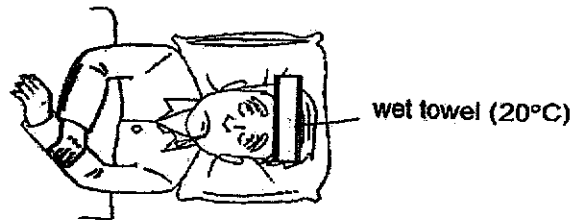

Which of the following statements explained the correct transfer of heat taking place?

- (1) The towel lost heat to his forehead.
- (2) His forehead lost heat to the towel.
- (3) His forehead gained heat from the towel.
- (4) The towel lost heat from the surroundings.

22. Jack set up the following experiment in a dark room as shown below. He placed the following wooden objects, A, B, C, at different positions between a light source and a screen.

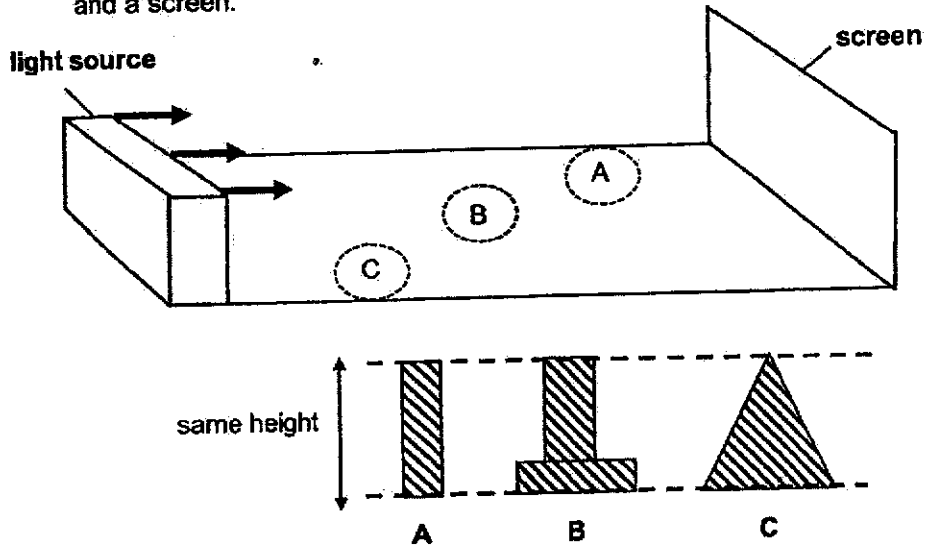

Which of the following shows the shadows formed on the screen?

(1)			
(2)			
(3)			
(4)			

23. Kirish used three different set-ups, A, B and C, to carry out some investigation about heat affecting temperature of water in different states in the kitchen.

- took a cup of ice cubes from the freezer and left it on a table
- took cup of hot water from a thermal flask and left it on a table
- took a pot of tap water and boil it using a stove

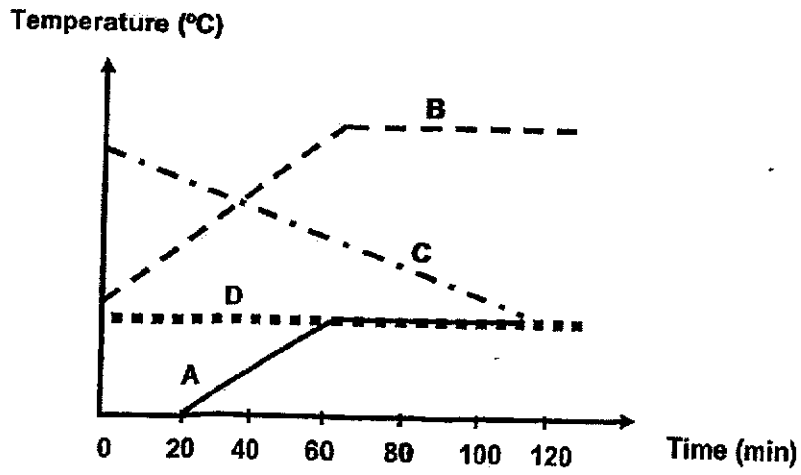

Based on the graphs, which of the following correctly describes the three set-ups?

	Leaving a cup of ice cubes	Leaving a cup of hot water	Boiling a pot of tap water
(1)	D	B	C
(2)	B	D	A
(3)	A	C	B
(4)	C	A	D

Study the diagrams carefully and answer questions 24 and 25.
 Su Ann placed a magnet on an electronic balance as shown in Diagram 1.

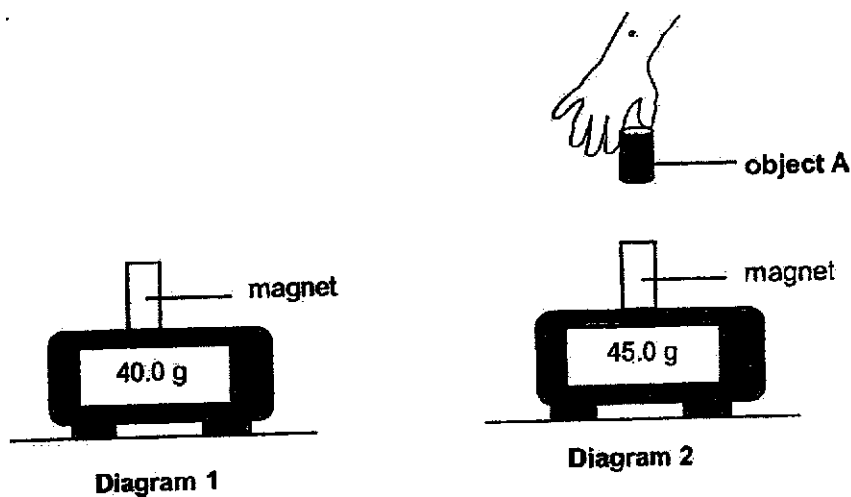

She brought object A closer towards the magnet as shown in Diagram 2.

24. Which of the following correctly represents object A?
- (1) copper
 - (2) iron
 - (3) aluminium
 - (4) magnet
25. Which of the following explains the interaction between magnet and object A in diagram 2?
- (1) Elastic spring force
 - (2) Gravitational force
 - (3) Magnetic force of repulsion
 - (4) Magnetic force of attraction

26. Study the diagrams below.

A

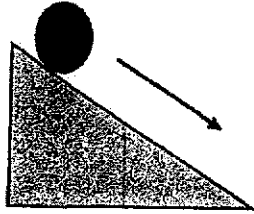

Ball moving down a slope

B

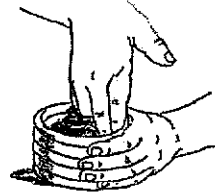

Moulding clay into a vase

C

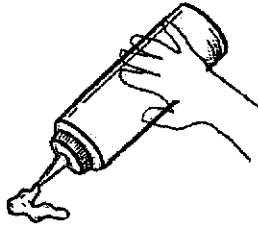

Squeezing a bottle

D



Pushing a bicycle

Which two of the above show that a force can change the shape of an object?

- (1) A and B only
- (2) B and C only
- (3) C and D only
- (4) A and D only

27. In the diagram below, the two circular buttons closed the flap of a bag when they were placed next to each other.

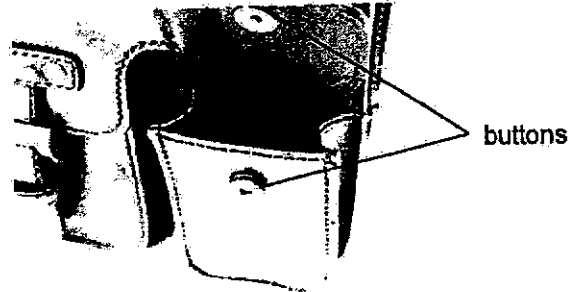

When iron paper clips were held next to the buttons, they moved towards both buttons.

Which of the following forces best explained the observations of the two buttons?

- (1) Frictional force
- (2) Magnetic force
- (3) Gravitational force
- (4) Elastic spring force

28. The diagrams below show a soldier jumping out of a plane from point D to E and then landing at F. He activated his parachute just after point D.

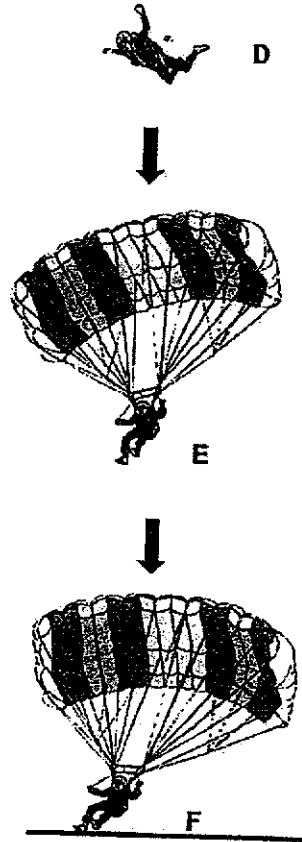

Which of the following statements is/are correct?

- A: The soldier moved his hands to increase his elastic spring force at D.
 B: There was gravitational force acting on the soldier at D, E and F.
 C: Frictional force is present between the soldier and the ground only at F.

- (1) B only
 (2) A and C only
 (3) B and C only
 (4) A, B and C



RED SWASTIKA SCHOOL

SCIENCE 2024 END-OF-YEAR EXAMINATION PRIMARY 5

Name : _____ ()

Class : Primary 5/ _____

Date : 21 Oct 2024

BOOKLET B

12 Questions
44 Marks

In this booklet, you **should** have the following:

- Page 22 to Page 39
- Questions 29 to 40

MARKS

	OBTAINED	POSSIBLE
BOOKLET A		56
BOOKLET B		44
TOTAL		100

Parent's Signature : _____

Answer all the questions in the spaces provided.

29. Baobei constructed a flowchart for her Science homework. Her teacher has circled the mistake and marked it with a cross. Study her flowchart below carefully.

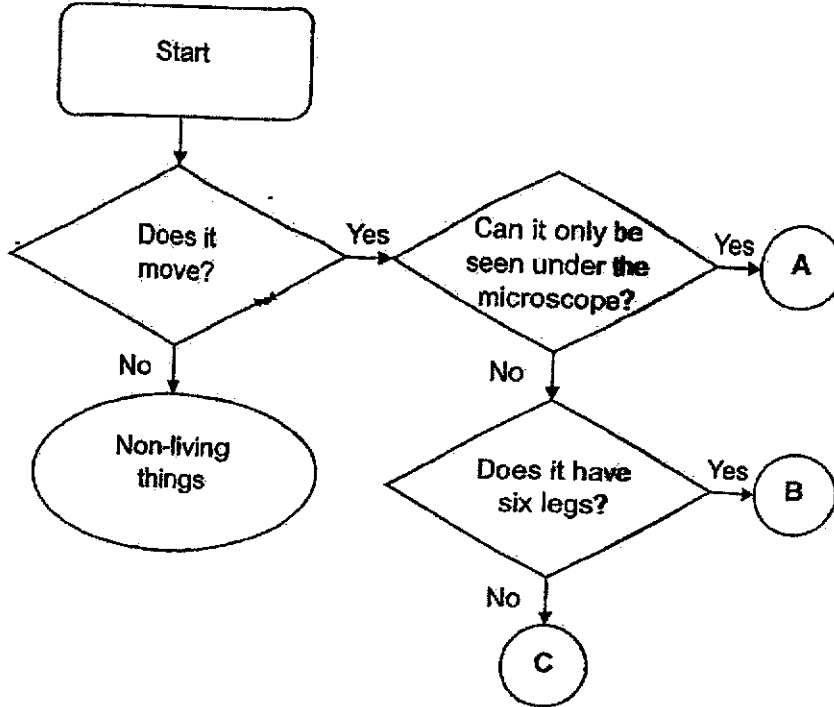

(a) She approached you for help with correcting the mistake.

(i) Explain why she was marked wrong. (1m)

(ii) Suggest a suitable question for part (ai). (1m)

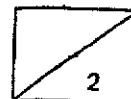

- (b) (i) Which group of living things does organism A belong to? (1m)

-
- (ii) Other than the characteristics given in the flowchart, state one other common characteristic that organism B has with the organism in the picture below. (1m)

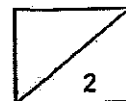
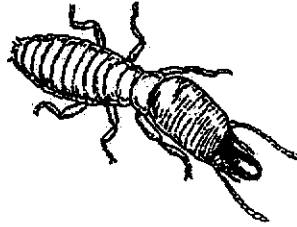

30. Look at the diagram below.

(a) Label parts, R and S, of the cell as shown in the diagram. (1m)

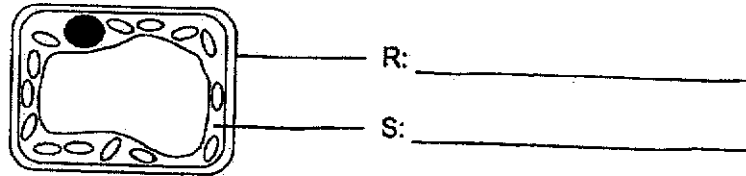

Mrs Teo placed the cell in a container filled with substances X and Y. She measured and monitored the amount of substances X and Y inside and outside the cell for over 10 minutes. The bar graphs below show the results.

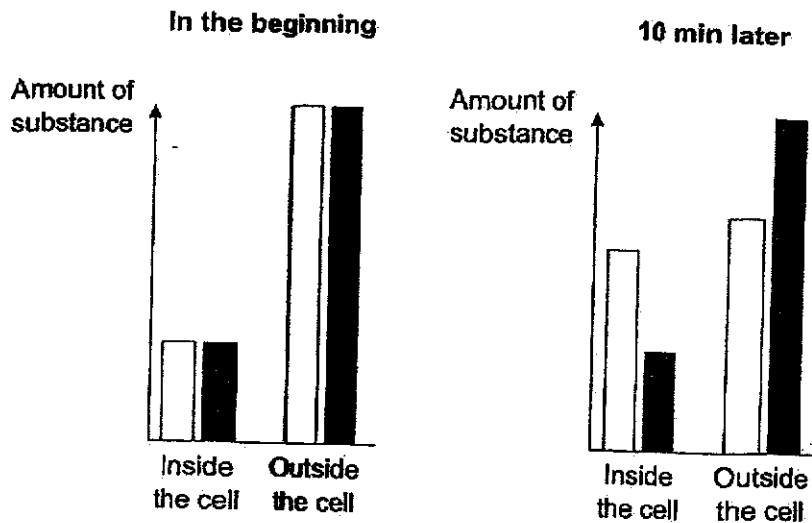

Key	
	Substance X
	Substance Y

(b) Name the part of the cell that allows for the results above to occur. Explain why. (2m)

31. Elite athletes watch their diet and breathing to boost their sports performance. They understand how the three body systems work together, as shown in the diagram below.

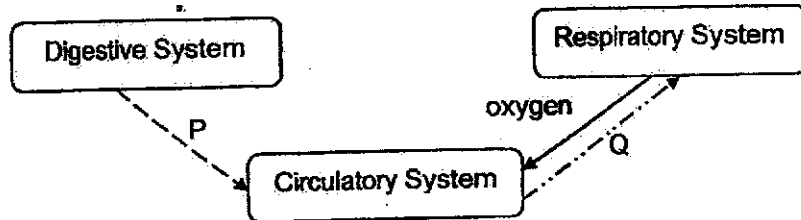

- (a) Identify substances P and Q in the diagram above. (1m)

P: _____

Q: _____

While running, Jaylen realised that his heart was beating very quickly.

- (b) Explain why Jaylen's heart rate increased during his run. (2m)

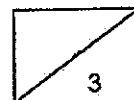

32. Carson removed an outer ring from the stem of a plant as shown below. The water-carrying tubes remained in the stem.

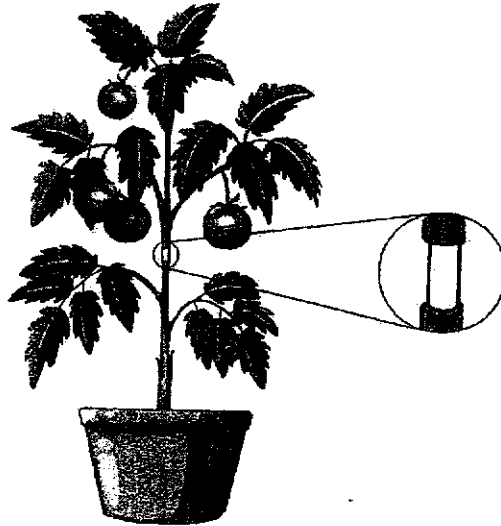

After some time, the plant produced bigger fruits than before.

- (a) Explain why the removal of an outer ring from the stem caused the plant to produce bigger fruits. (2m)

- (b) Will the roots die after two months? Explain your answer. (1m)

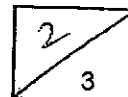

33. (a) Use a pencil to draw the life cycle of a mosquito using only words and arrows. (1m)

- (b) The diagram shows the life cycle of organism D. Its young can be found in the same aquatic habitat as the young of the mosquito.

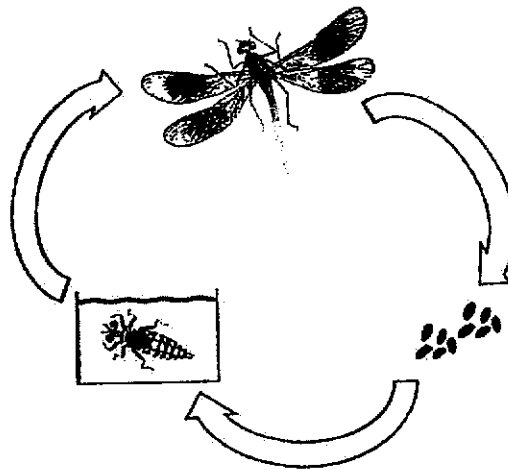

State one difference between the life cycle of organism D and that of a mosquito. (1m)

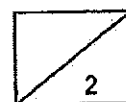

A research study was conducted to find out how aging affects sperm count in men. The results are recorded in the table below.

Age group (years)	Total sperm count (million)
29 – 35	150
36 – 42	120
43 – 49	112
50 – 60	61

- (c) Based on the study, explain how the age of the father affects the chances of having a baby? (2m)

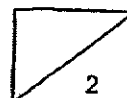

34. (a) Observe the diagram of flower X carefully.

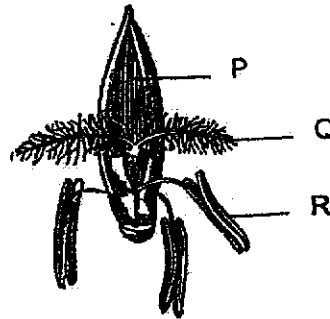

Flower X

- (i) Two parts of flower X were removed before pollination could occur. After some time, a fruit is formed.

Which two parts (P, Q or R) of the flower had been removed?
(1m)

- (ii) Based on the diagram, how is flower X likely to be pollinated?
State the characteristic of the flower to support your answer.
(1m)

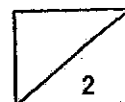

(b) The diagram shows dispersal pattern of four plants.

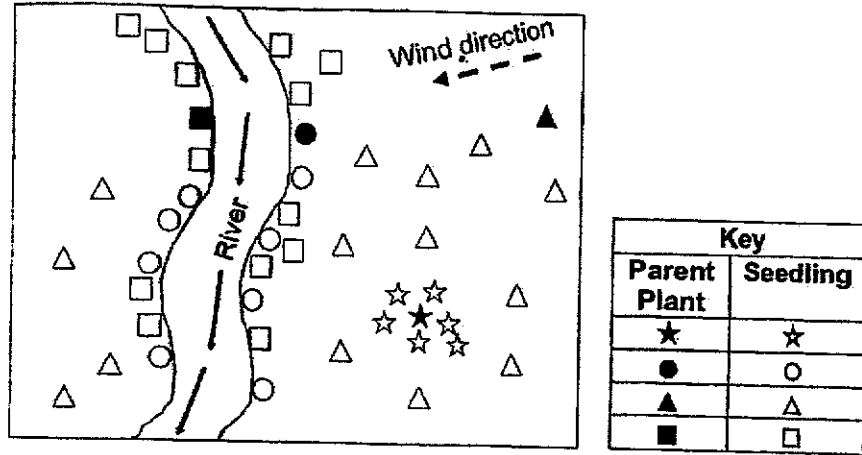

Based on the diagram, identify the likely dispersal method and a possible characteristic of its fruit/seed for each plant in the table below. An example has been done for you. (3m)

Plant	Dispersal method	Characteristic of fruit/seed
★	splitting/ explosive action	pod-like structure
●		
▲		
■		

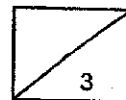

35. Identical bulbs A, B, C, D and E were connected in a circuit as shown below. All the light bulbs were new and lighted up when the circuit was closed.

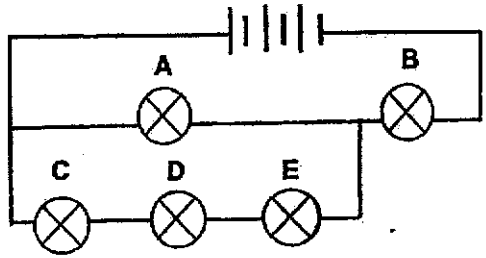

(a) Which bulb(s) will light up when one bulb is removed? (2m)

Bulb removed	Bulb lighted
A	
B	
C	A and B

(b) Based on the circuit, state the arrangement for bulbs C, D and E. (1m)

(c) Describe one disadvantage for the type of bulb arrangement in (b). (1m)

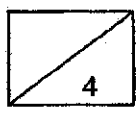

35. The diagram below shows a set-up that uses three identical lamps to heat food at a buffet. The lamps give out more heat when their brightness increases.

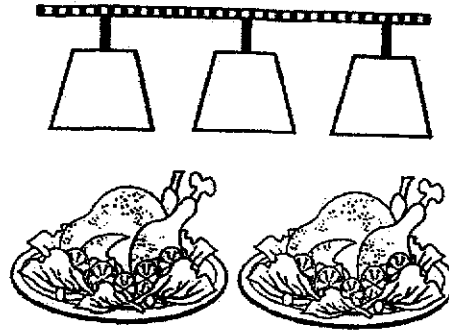

- (d) Use a pencil and ruler to complete the circuit such that the arrangement of the three bulbs will give out the most brightness and heat. (1m)

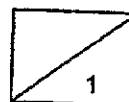
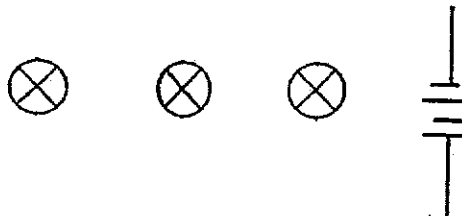

36. Mdm Jamal wanted to find out how temperature affected the change of water from liquid state to gaseous state. She filled three identical measuring cylinders, E, F and G with 80 ml of water each at different temperature and placed them in the Science Laboratory for ten hours.

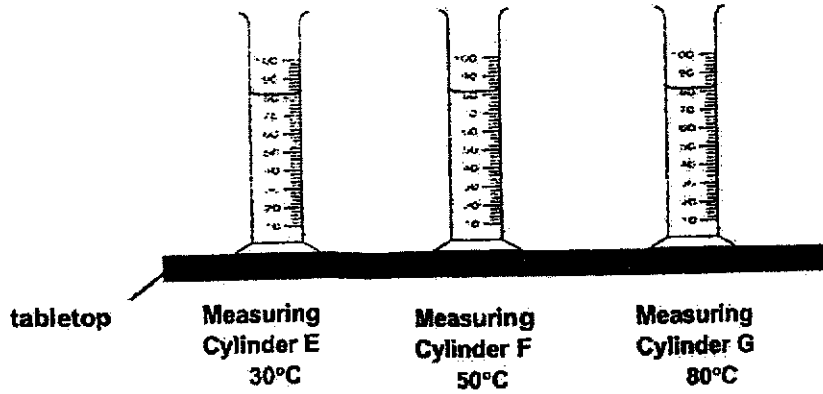

She recorded the amount of water left in each cylinder in the table below.

	Amount of water left (ml)		
	E	F	G
1st trial	75	56	35
2nd trial	74	57	34
3rd trial	73	58	33

(a) Why did Mdm Jamal repeat the experiment three times? (1m)



(b) In the experiment above, name the process that caused water to change from liquid state to gaseous state. (1m)

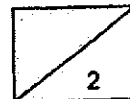

(c) Why did Mdm Jamal use a measuring cylinder instead of a measuring beaker? (1m)

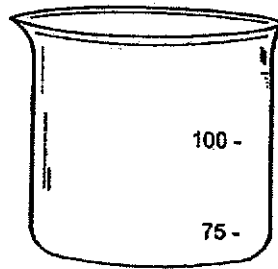

Measuring beaker

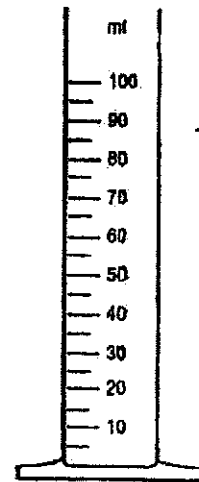

Measuring cylinder

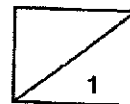

37. Meimei conducted an experiment to study the water cycle. She poured 100 ml of water at 80°C into two identical beakers. Next, she placed metal trays of water at 5°C and 30°C above each beaker as shown.

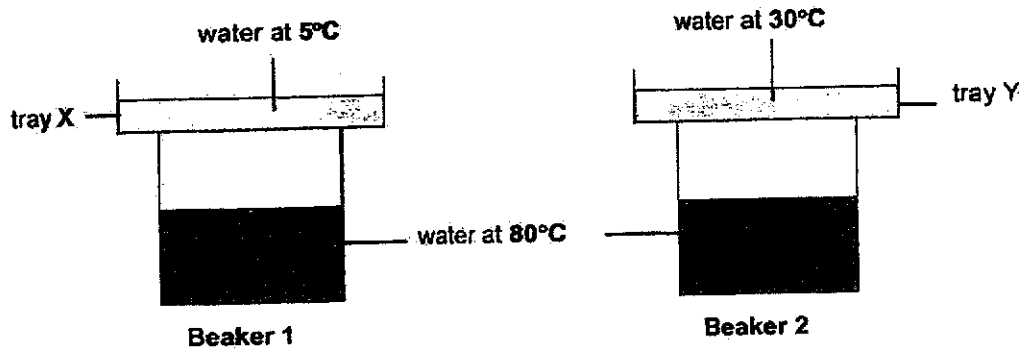

After 5 minutes, she counted the number of water droplets formed on the underside of each tray and recorded the data in the table below.

Metal Tray	Number of water droplets formed underside of the tray
X	25
Y	10

- (a) Name the water process which caused water droplets to be formed on both trays. (1m)

- (b) She concluded that her experiment above was a fair one. State the only changed variable. (1m)

- (c) Explain why there were more water droplets formed on tray X. (1m)

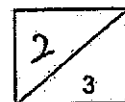

38. Daryl set up a light sensor and a light source as shown. He wanted to count the number of identical boxes moving on a belt for 10 mins. The boxes are similar in shape and size.

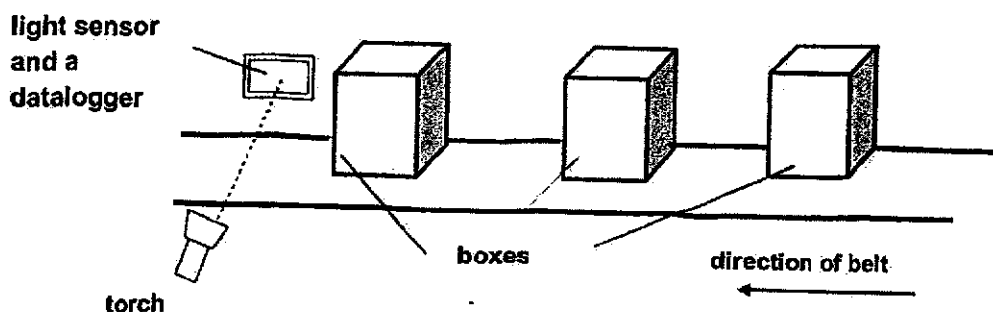

When the boxes moved past the light sensor, there would be a decrease in the amount of light detected. The following results were recorded by the datalogger.

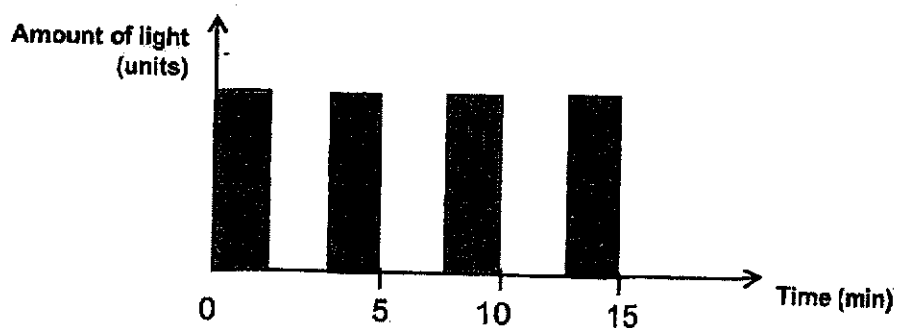

- (a) In order for the set-up to work, state one property of light. (1m)

- (b) Based on the above graph, how many boxes have moved past the light sensor in the first 10 minutes? (1m)

- (c) Explain your answer in (b). (1m)

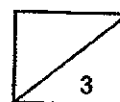

39. Shirley conducted an experiment whereby she poured 50 cm³ of water into two identical containers A and B. These containers were on different tables placed in the same room. A lamp is placed above Container B as shown below.

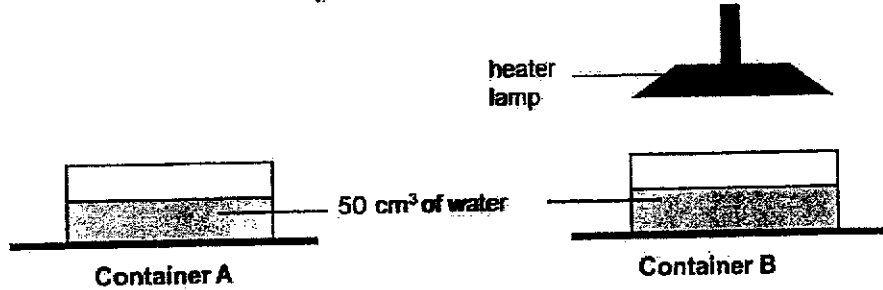

(a) Why did water in container B have a higher temperature after five hours. (1m)

Next, Shirley wanted to dry her wet hair in a shorter time after a shower. She pressed one function of the hairdryer as shown.

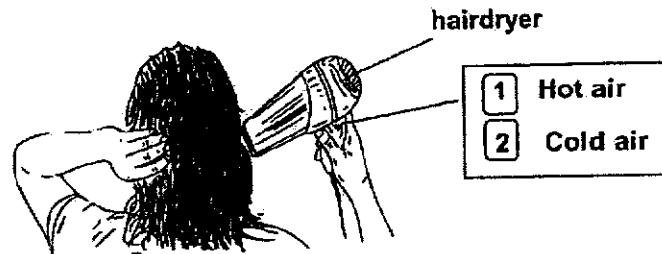

(b) Which button, 1 or 2 did Shirley press? (1m)

(c) Describe how Shirley took a shorter time to dry her hair by pressing the button stated in (b). (1m)

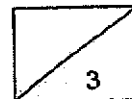

40. Maya set up a simplified representation of a spring weighing scale as shown in the diagram below.

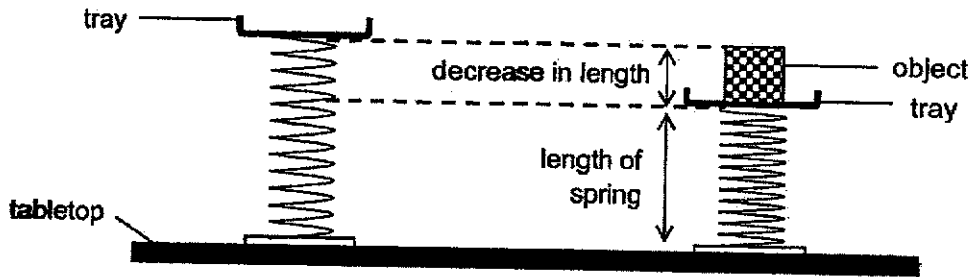

The length of the spring changes when objects of mass such as 50g, 100g and 150g were being placed on the tray.

- (a) Complete the bar graph below for items weighing 50g and 150g. (1m)
The bar showing the length of spring for the item weighing 100g had been done for you.

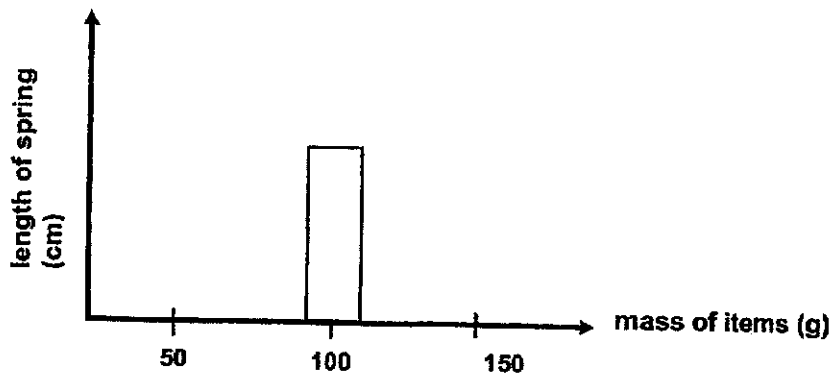

When the items were removed from the plate, it was observed that the spring went back to its original length.

- (b) Name the two forces required for the set-up above to work properly. (2m)

Force 1 : _____

Force 2 : _____

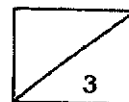

40. In a cafe where Maya worked, a special tray was placed on the spring weighing scale as shown below. When the tray was filled with plates, the buzzer would not sound. Once the tray was emptied, the buzzer would sound to alert the staff to refill the plates.

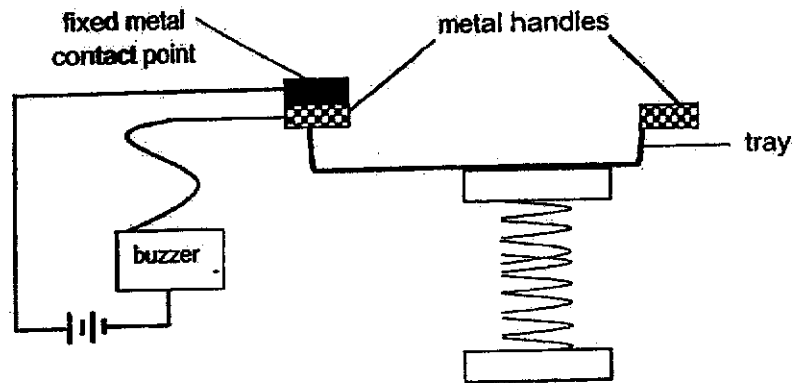

Diagram 1

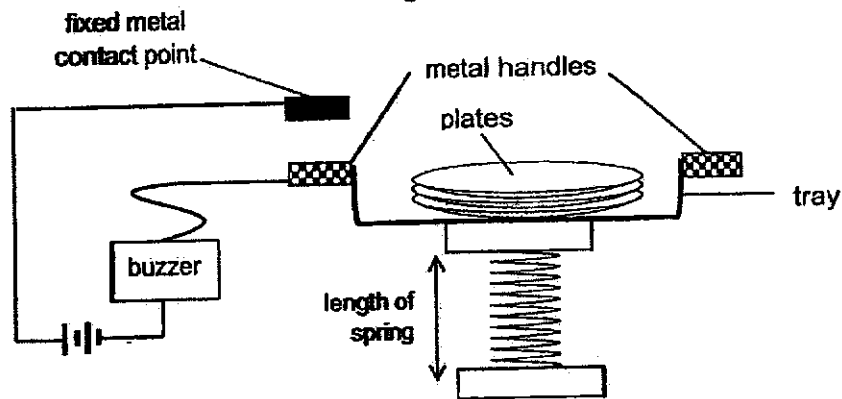
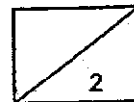

Diagram 2

- (c) In terms of forces based on the set-up above, explain why the tray moved downwards when it was full of plates. (1m)

- (d) Many months later, the buzzer did not sound even when the tray was empty. Maya checked and found that the components of the electrical circuit were working. What could be the reason? (1m)



Corrections for 2024 P5 Science End of Year Exam Paper

Name: _____

Date: _____

Class: P5/ _____ ()

Section A: Multiple Choice Questions

1	(3)	6	(4)	11	(1)	16	(3)	21	(2)	26	(2)
2	(4)	7	(2)	12	(3)	17	(1)	22	(4)	27	(2)
3	(2)	8	(3)	13	(2)	18	(3)	23	(3)	28	(3)
4	(2)	9	(4)	14	(1)	19	(3)	24	(4)		
5	(1)	10	(2)	15	(2)	20	(4)	25	(3)		

Section B: Open-ended Section

29a i)	Some non-living things can <u>move</u> , such as <u>battery-operated toys</u> . Some living things also cannot <u>move</u> , such as <u>trees</u> .
29a ii)	Does it need <u>air, food and water</u> to survive? Can it <u>grow respond to changes and reproduce</u> ?
29b i)	<u>bacteria</u>
29b ii)	It has <u>three</u> body parts.
30a	R: <u>cell wall</u> S: <u>cytoplasm</u>
30b	The <u>cell membrane</u> It <u>controls</u> the movement of substances in and out of the cell.
31a	P: <u>Digested food</u> Q: <u>carbon dioxide</u>
31b	The heart pumps <u>faster</u> to transport more oxygen and more digested food to all parts of the body to produce more energy.
32a	The <u>food-carrying tubes</u> were removed. Food made by the leaves during photosynthesis cannot be <u>transported</u> past the cut down to the roots. Thus, <u>more</u> food was transported to the fruits to be <u>stored</u> causing the fruits to become <u>bigger</u> .
32b	The roots will <u>not</u> die in the long run. Food made by the leaves <u>below</u> the cut stem can be transported down to the roots.
33a	<pre> graph TD adult --> egg egg --> larva larva --> pupa pupa --> adult </pre>

33b	The life cycle of organism D has <u>three</u> stages but the life cycle of a mosquito has <u>four</u> stages.																		
33c	As the age <u>increases</u> , the total sperm count <u>decreases</u> , hence <u>reducing</u> the chance of them having a baby.																		
34a i)	P and R																		
34a ii)	<u>Wind</u> pollinated Its <u>stigma</u> is/are hanging <u>outside</u> .																		
34b	<table border="1"> <thead> <tr> <th>Plant</th> <th>Dispersal method</th> <th>Characteristic of fruit/seed</th> </tr> </thead> <tbody> <tr> <td>★</td> <td><u>splitting/ explosive action</u></td> <td><u>pod-like structure</u></td> </tr> <tr> <td>●</td> <td><u>water</u></td> <td><u>fibrous husk / waterproof outer layer</u></td> </tr> <tr> <td>▲</td> <td><u>wind</u></td> <td><u>wing-like / feather-like structure</u></td> </tr> <tr> <td>■</td> <td><u>animals</u></td> <td><u>juicy fruit with hard/indigestible seed</u></td> </tr> <tr> <td></td> <td></td> <td><u>have hooks or stiff hair</u></td> </tr> </tbody> </table>	Plant	Dispersal method	Characteristic of fruit/seed	★	<u>splitting/ explosive action</u>	<u>pod-like structure</u>	●	<u>water</u>	<u>fibrous husk / waterproof outer layer</u>	▲	<u>wind</u>	<u>wing-like / feather-like structure</u>	■	<u>animals</u>	<u>juicy fruit with hard/indigestible seed</u>			<u>have hooks or stiff hair</u>
Plant	Dispersal method	Characteristic of fruit/seed																	
★	<u>splitting/ explosive action</u>	<u>pod-like structure</u>																	
●	<u>water</u>	<u>fibrous husk / waterproof outer layer</u>																	
▲	<u>wind</u>	<u>wing-like / feather-like structure</u>																	
■	<u>animals</u>	<u>juicy fruit with hard/indigestible seed</u>																	
		<u>have hooks or stiff hair</u>																	
35(a)	<table border="1"> <thead> <tr> <th>Bulb removed</th> <th>Bulb lighted</th> </tr> </thead> <tbody> <tr> <td>A</td> <td>B, C, D, E</td> </tr> <tr> <td>B</td> <td>None</td> </tr> <tr> <td>C</td> <td>A and B</td> </tr> </tbody> </table>	Bulb removed	Bulb lighted	A	B, C, D, E	B	None	C	A and B										
Bulb removed	Bulb lighted																		
A	B, C, D, E																		
B	None																		
C	A and B																		
35(b)	Bulbs C, D and E are arranged in <u>series</u> .																		
35(c)	When one bulb <u>fuses</u> , the other bulb <u>cannot light</u> . Electricity cannot flow in an <u>open circuit</u> .																		
35(d)	<p>The diagram shows a battery on the right connected to a parallel circuit. The circuit branches into three vertical paths, each containing a light bulb (represented by a circle with an 'X'). The paths recombine and return to the battery.</p>																		

36(a)	Mdm Jamal repeated the experiment to ensure that her results are <u>reliable</u> .
36(b)	The process is <u>evaporation</u> .
36(c)	The measuring cylinder has <u>smaller</u> intervals to measure the volume of water measurements at 5ml intervals.
37(a)	The process is <u>condensation</u> .
37(b)	The <u>temperature</u> of water in the tray is the only changed variable.
37(c)	Water in Tray X has a <u>lower</u> temperature. Water vapour which touched the cooler tray lost <u>more</u> heat and condenses into more water droplets.
38(a)	Light travels in <u>straight</u> lines.
38(b)	<u>2</u> boxes have moved past the light.
38(c)	When the box <u>blocked</u> the light from passing through, the sensor recorded a 0 reading. Thus, 2 zero readings meant that there were 2 boxes.
39(a)	Water (in container B) <u>gained</u> heat from the lamp and its temperature increased.
39(b)	Button 1 was pressed.
39(c)	The water in the hair <u>gained</u> heat from the <u>hot air</u> and <u>evaporated</u> more quickly into water vapour. As the rate of <u>evaporation</u> of water is <u>faster</u> , less water was left on her hair which <u>dried</u> in a shorter time.

<p>40(a)</p>	
<p>40(b)</p>	<p>Force 1: <u>Elastic spring force</u> Force 2: <u>gravitational force</u></p>
<p>40(c)</p>	<p>The <u>gravitational</u> force acting on the plates is <u>greater</u> than the <u>elastic spring force</u> force. Thus, it pushes the plate downwards.</p>
<p>40(d)</p>	<p>The elastic spring lost its <u>elasticity</u>.</p>