



RAFFLES GIRLS' PRIMARY SCHOOL

SEMESTRAL ASSESSMENT (2)
2018

Section A	50
Section B	40
Your score out of 90	90
Parent's signature	

Name _____ Index No: _____ Class: P 5 _____

25 October 2018 **SCIENCE** Attn: 1 h 30 min

SECTION A (25 X 2 marks)

For each question from 1 to 25, four options are given. One of them is the correct answer. Make your choice (1, 2, 3 or 4). Shade the correct oval on the Optical Answer Sheet.

1. The diagram below shows a process in the human reproduction system.

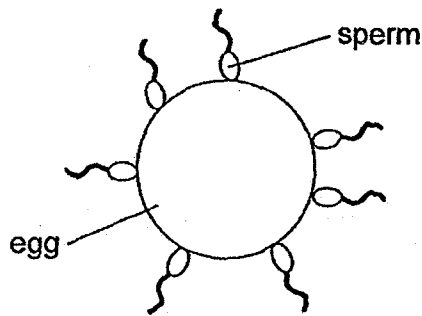

Which one of the following statements about the process of human reproduction is correct?

- (1) One egg is fertilised by many sperms.
- (2) Pollination occurs before the fertilisation of the egg.
- (3) The foetus will develop in the womb for nine months.
- (4) The male reproductive cell will fuse with the female reproductive cell in the womb.

2. The table below shows some physical characteristics of Mr and Mrs Ben and their four children. A tick (✓) shows the presence of the characteristics.

	Short hair	Curly hair	Dimples	Attached earlobes
Mr Ben	✓	✓		✓
Mrs Ben			✓	
Alex	✓			
Billy	✓	✓		✓
Cindy		✓	✓	
Elly		✓	✓	

Based on the information above, which of the following statement(s) is/are definitely correct?

- A Cindy and Elly are a pair of twins.
- B Billy and Alex inherited the short hair from Mr Ben.
- C Billy did not inherit any physical characteristics from Mrs Ben.
- D Cindy and Elly each inherited more than two physical characteristics from Mrs Ben.

- (1) C only
- (2) A and B only
- (3) B and C only
- (4) A, C and D only

3. The cycle below show the stages of the growth of a plant.

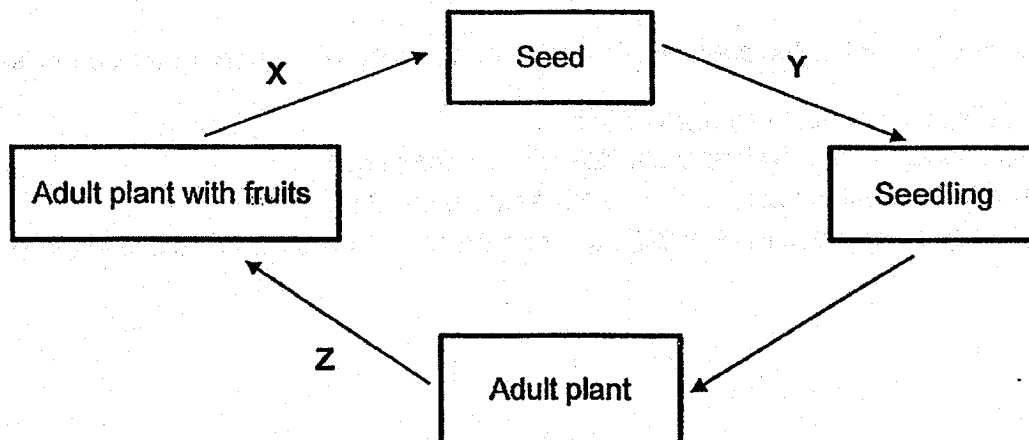

Which of the following represents the stages correctly?

	X	Y	Z
(1)	Dispersal	Germination	Fertilisation
(2)	Fertilisation	Dispersal	Germination
(3)	Germination	Fertilisation	Dispersal
(4)	Germination	Dispersal	Fertilisation

4. The chart below shows classification of some living things.

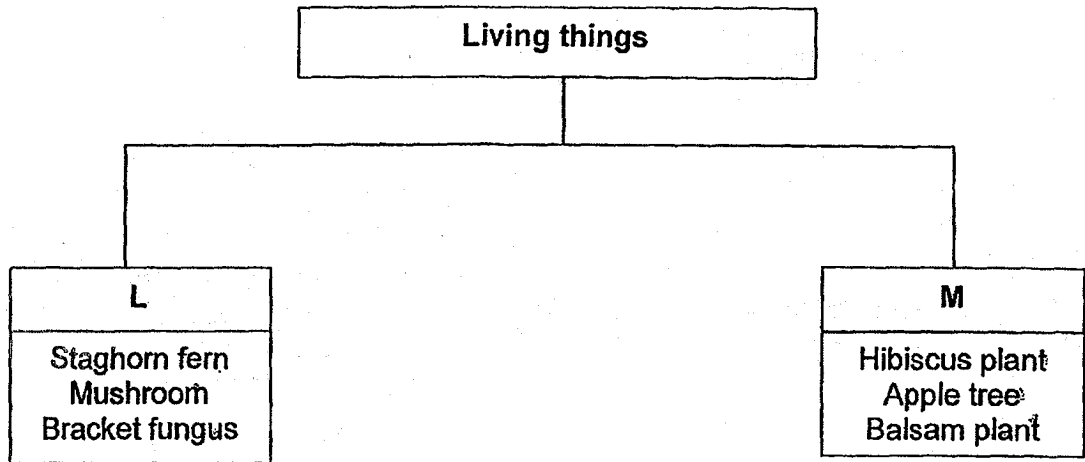

Which of the following is the most suitable headings for L and M?

	L	M
(1)	Inedible	Edible
(2)	Non-flowering plants	Flowering plants
(3)	Non-green plants	Green plants
(4)	Reproduce from spores	Reproduce from seeds

5. Study the diagram below.

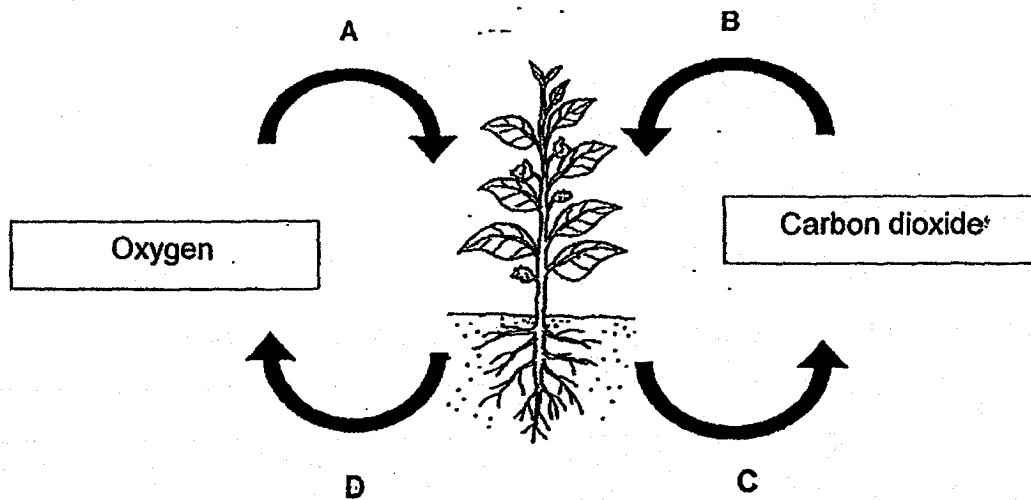

Which pair of arrows shows the exchange of gases during respiration correctly?

- (1) A and B
- (2) A and C
- (3) A and D
- (4) C and D

6. Study the flow chart about different parts P, Q, R and S in human digestive system below.

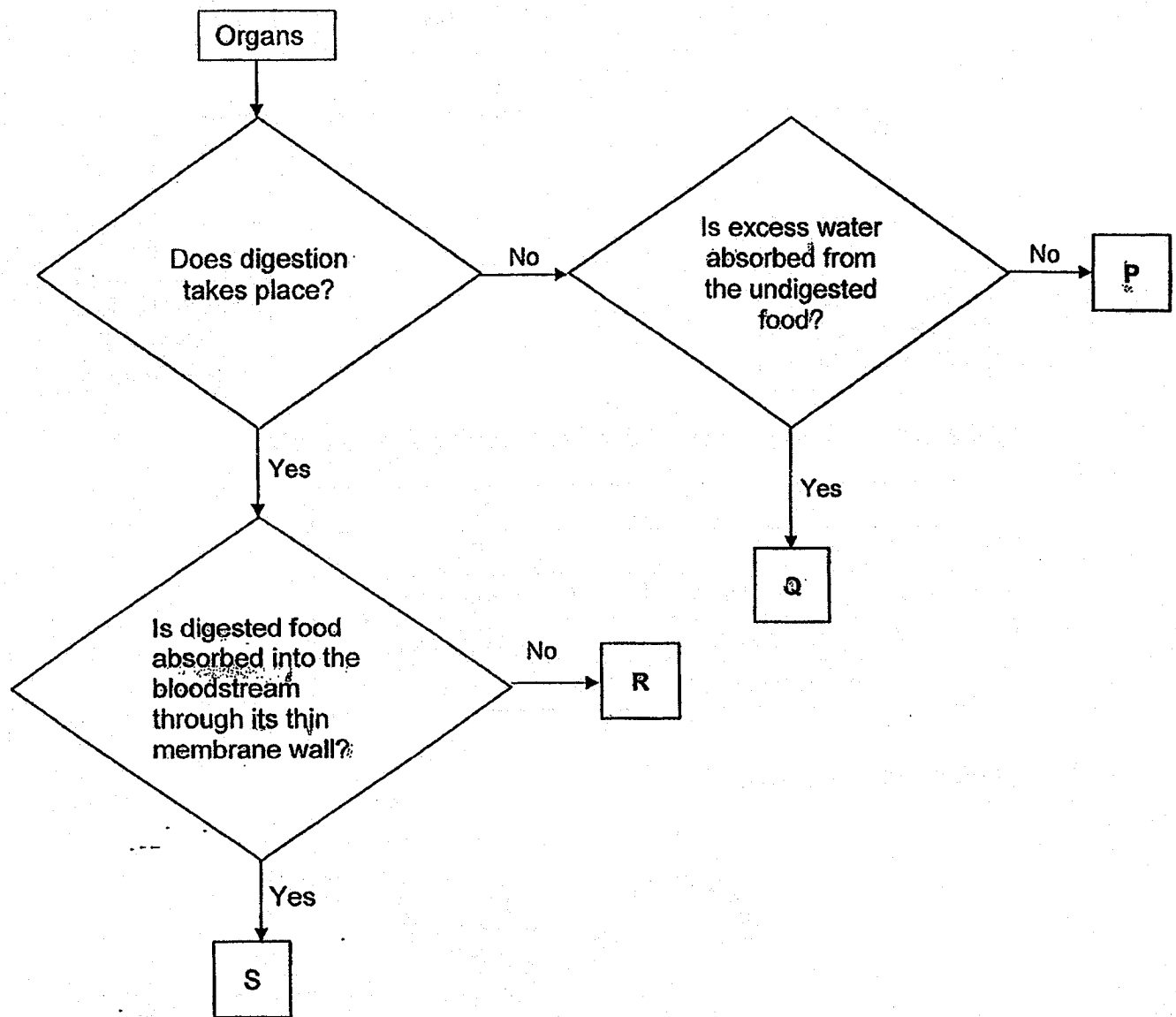

Which of the following best represents P, Q, R and S respectively?

	P	Q	R	S
(1)	Anus	Large intestine	Mouth	Small intestine
(2)	Gullet	Mouth	Small intestine	Large intestine
(3)	Mouth	Small intestine	Stomach	Small intestine
(4)	Large intestine	Small intestine	Stomach	Mouth

7. The experimental set-up below was placed beside an open window during a sunny and bright day.

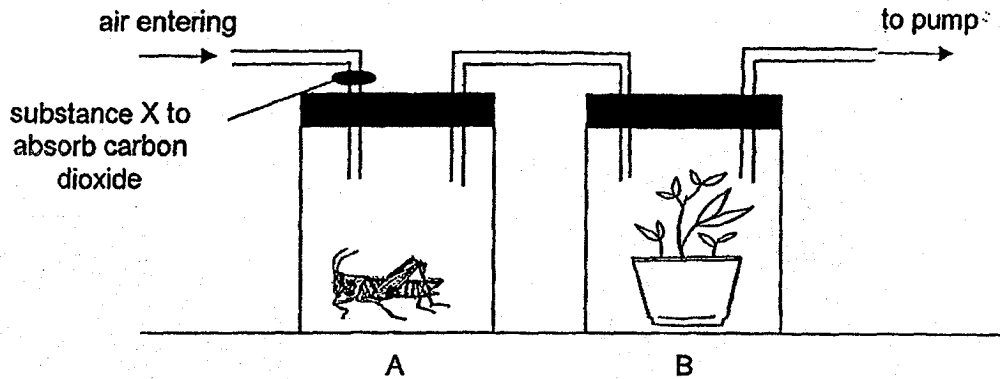

Which of the following pairs shows the gases that enter and leave container B?

	Entering	Leaving
(1)	Oxygen, carbon dioxide	Oxygen, water vapour
(2)	Oxygen, water vapour	Oxygen, water vapour
(3)	Oxygen, carbon dioxide, water vapour	Oxygen, carbon dioxide, water vapour
(4)	Oxygen, carbon dioxide, water vapour	Oxygen, water vapour

8. Set-up X shows how sand is separated from water using filter paper. The filter paper only allows some substances to pass through it.

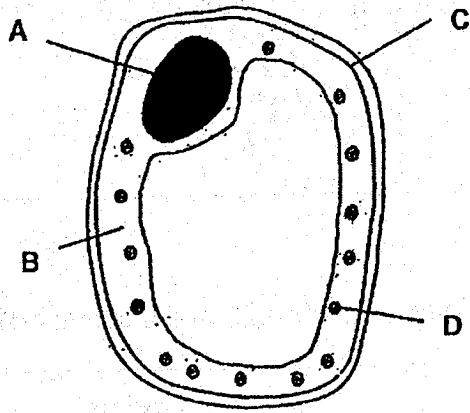

Plant cell

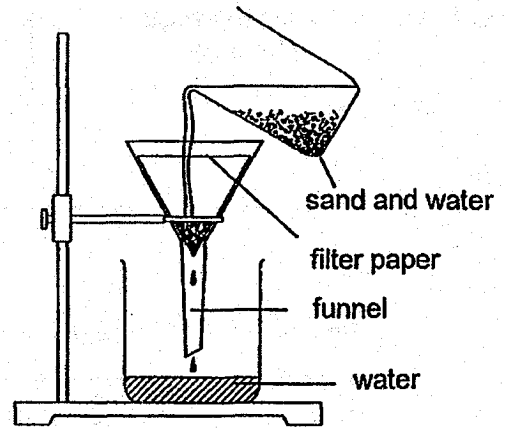

Set-up X

Which part of the plant cell has the same function as the filter paper in set-up X?

- (1) A
- (2) B
- (3) C
- (4) D

9. The diagram below shows the human respiratory system with parts labelled A and B.

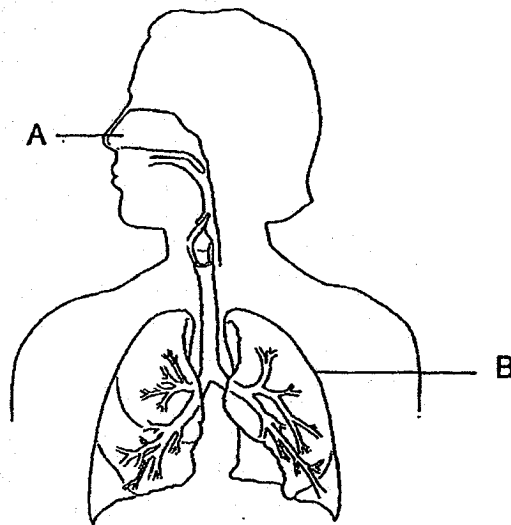

Which one of the following correctly states the functions of A and B during breathing?

	A	B
(1)	Controls the types of gases that enter the lungs	Controls the rate of breathing
(2)	Enables us to detect smell	Prevents the ribcage from collapsing
(3)	Filters the air before it enters the lungs	Takes in oxygen and remove carbon dioxide
(4)	Leads air in and out of the respiratory system	Makes the chest cavity air-tight

10. The diagram below shows how blood flows through the blood vessels from P to Q.

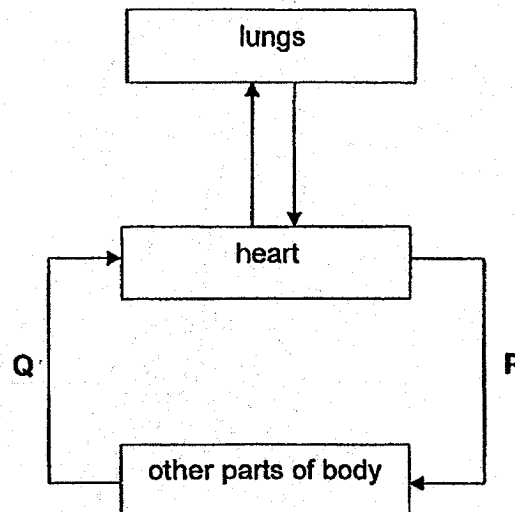

Which of the following best describe the differences between the blood at blood vessels P and Q?

	Blood at P	Blood at Q
A	more oxygen	less oxygen
B	less carbon dioxide	more carbon dioxide
C	less waste materials	more waste materials
D	more digested food	less digested food

- (1) A and C only
- (2) B and D only
- (3) A, B and C only
- (4) A, B, C and D

11. Mary took plant X from the garden and placed in a container filled with water as shown below.

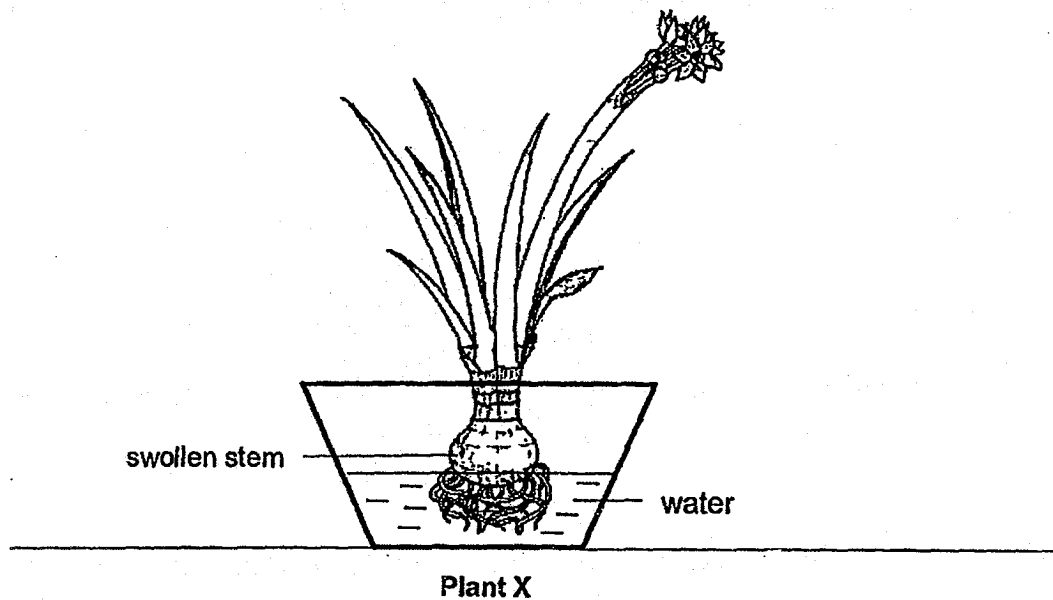

Mary noticed that plant X in her garden grew more healthily but plant X left in the living room withered in a month.

Which of the following is/are the reason(s) for her observation?

- A There was insufficient mineral salts present in the water to be absorbed by the roots of the plant X.
- B There was insufficient light present in the room for the leaves of the plant to make food.
- C The stem of plant X became swollen and could not transport water from the roots to the leaves.

- (1) C only
- (2) A and B only
- (3) A and C only
- (4) A, B and C

12. Peter placed a celery stalk as shown in the picture below. The two glasses had different coloured water, one red and the other blue. After half an hour, he cut across the stalks at positions X, Y and Z, as shown in the diagram below.

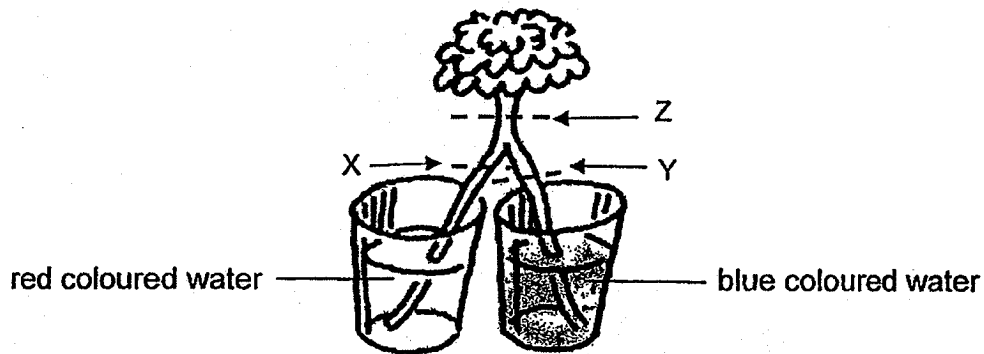

He noticed that the cross-sections cut at X, Y and Z had different coloured dots.

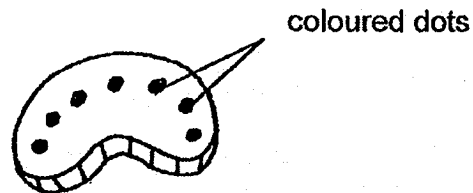

Cross-section of celery stalk

Which of the following shows the possible colour dots observed at parts X, Y and Z of the stem?

	X	Y	Z
(1)	All red	All blue	Some red and some blue
(2)	All blue	All red	All purple
(3)	All purple	All purple	Some red and some blue
(4)	All red	All blue	All purple

13. The graph below shows the melting point and boiling point of Substance A.

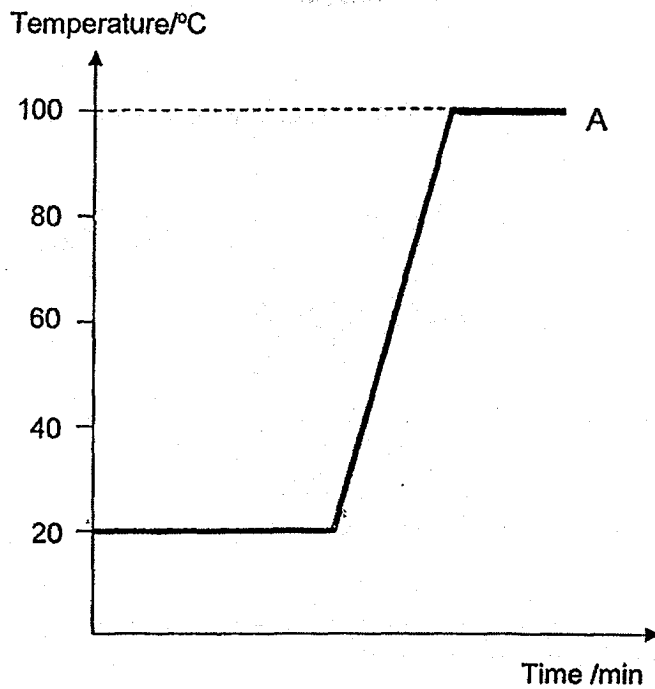

Which one of the following statements about the graph above is not correct?

- (1) Substance A is a solid at 10 °C.
- (2) Substance A is a liquid at 80 °C.
- (3) The melting point of substance A is 0 °C.
- (4) The boiling point of substance A is 100 °C.

14. Siti left a block of ice in a beaker on an electronic weighing scale in the kitchen as shown below.

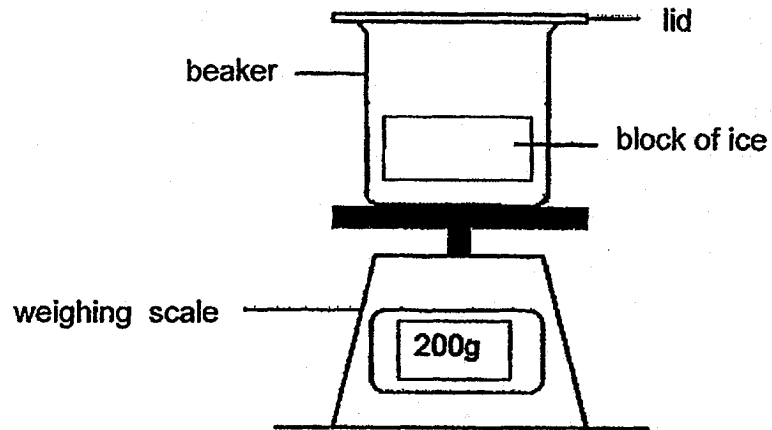

Which of the following statement(s) is/are the most likely observation(s) when the block of ice was left on the weighing scale for five minutes?

- A Water droplets are formed on the underside of the lid.
 - B Water droplets are formed on the outside of the beaker.
 - C The reading in the weighing scale shows more than 200g.
- (1) A only
(2) B only
(3) B and C only
(4) A, B and C

15. When object U is placed in front of a light source, Peter observed a circular shadow formed on the screen.



Torch



Object U



screen

Which one of the following actions will have a bigger shadow be cast on the screen?

- (1) Move the torch nearer to object U
- (2) Move the screen nearer to object U.
- (3) Move the torch further from object U.
- (4) Move object U further from the torch.

16. Ali cut out a circular shape from a wooden block and a triangular shape from a clear plastic block as shown below.

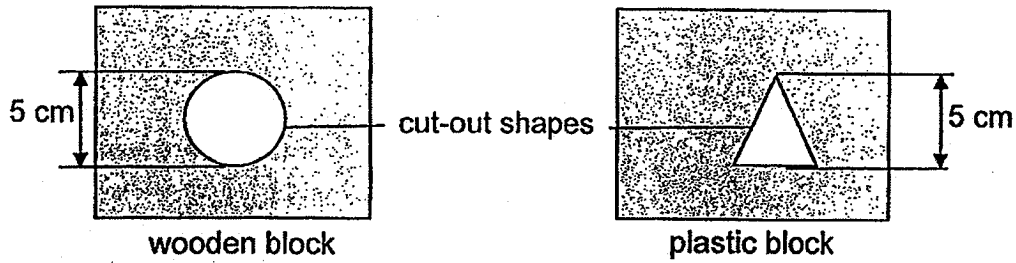

He glued the two blocks together and a lamp with blue light was brought near the two blocks which were glued together as shown in the diagram below.

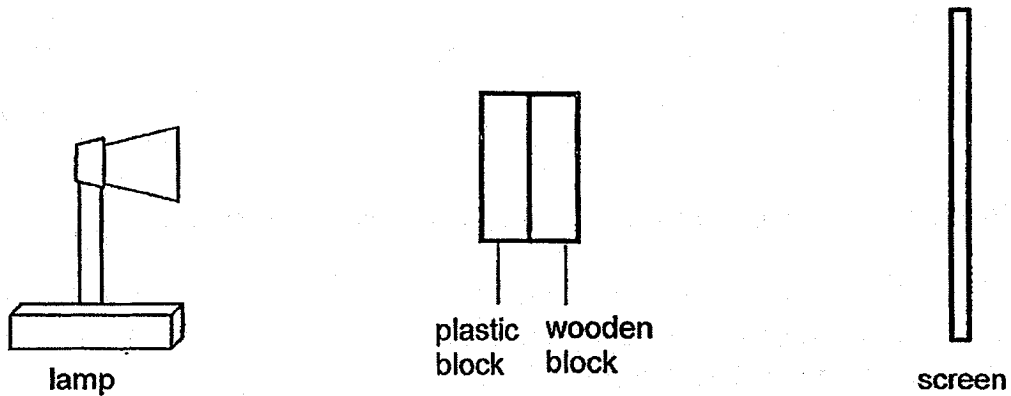

Which one of the following is most likely to be the shadow formed on the screen?

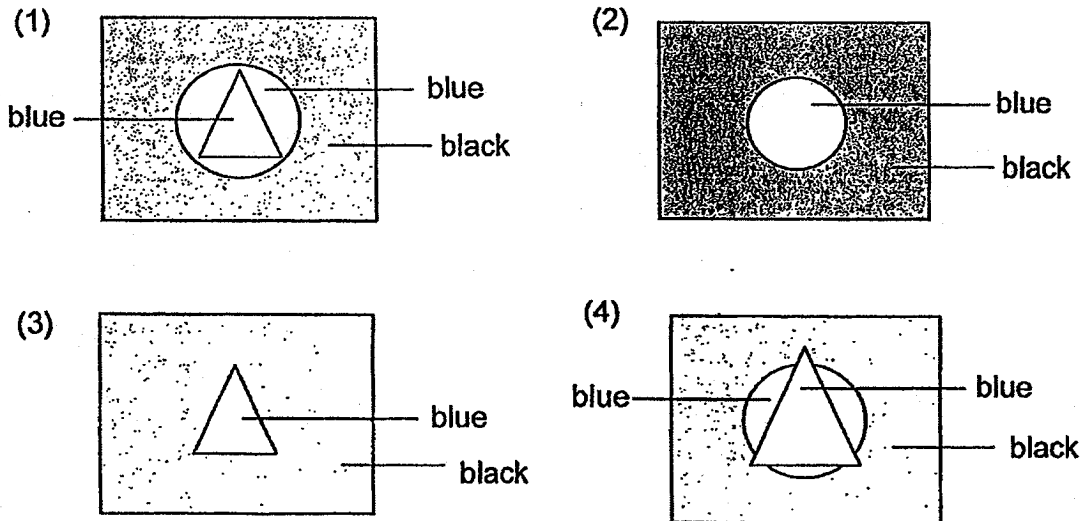

17. Which one of the following diagram explains why Judy can see the book on the table when the lamp is switched on?

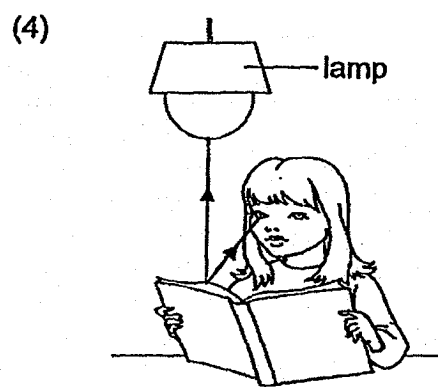
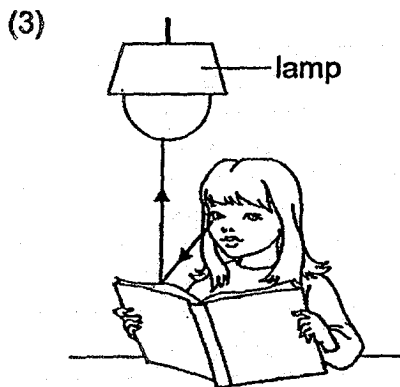
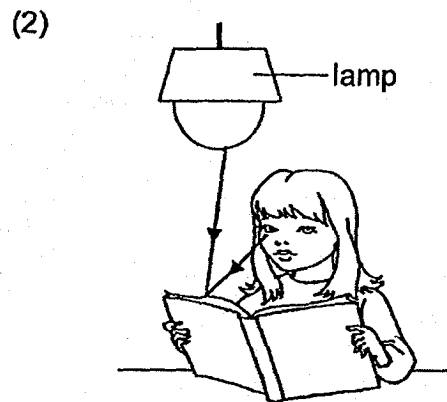
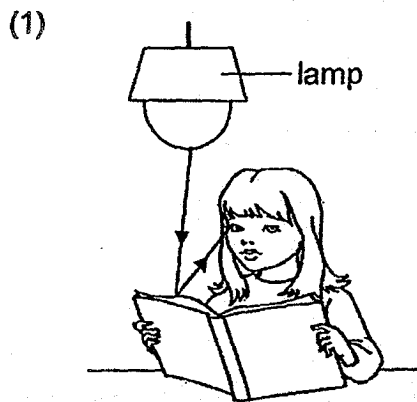

18. Joseph placed a bowl of ice-cream on the table. After three minutes, he observed his ice-cream melting slowly.

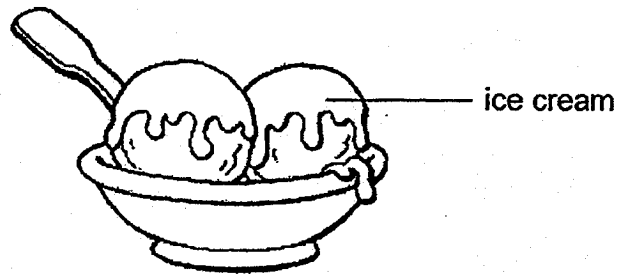

Which of the following correctly shows the transfer of heat between the ice-cream and the surrounding air?

	Surrounding air	Ice-cream
(1)	gains heat	gains heat
(2)	gains heat	loses heat
(3)	loses heat	loses heat
(4)	loses heat	gains heat

19. Winson conducted an experiment using two containers, R and S, made of different materials. He placed an equal amount of water at 5°C in each container as shown below. He used a hot plate to heat the two containers of water to boiling point.

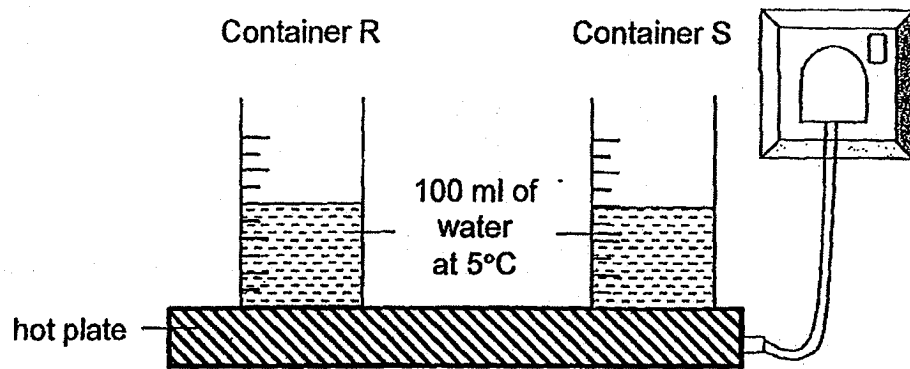

He measured the time taken for the water in each container to reach boiling point and recorded the readings in the table below:

Container	Time Taken (s)
R	70
S	120

Based on the information above, which of the following statement(s) is/are correct?

- A Container R is a poorer conductor of heat than container S.
 - B The water in container S gained heat from the hot plate more slowly than the water in container R.
 - C The water in both containers would have the same amount of heat energy at boiling point.
- (1) A only
(2) B only
(3) B and C only
(4) A, B and C only

20. Mrs Wong set-up an experiment as shown below.

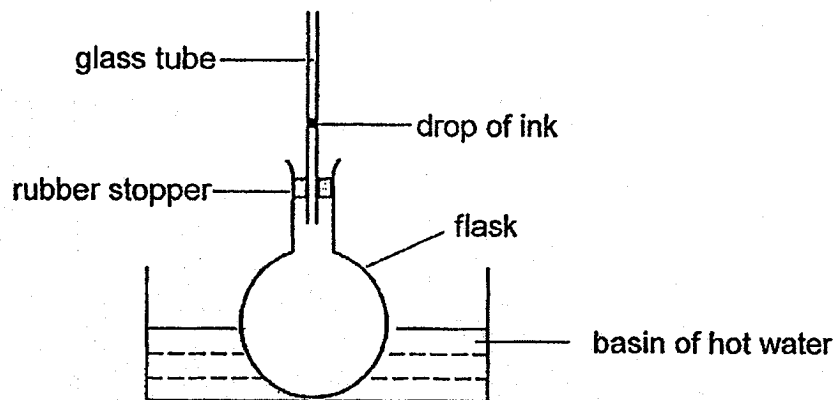

Which of the following statements correctly shows the observation and explanation of what happen to the drop of ink after the flask was placed in the basin of hot water?

	Observation	Explanation
(1)	The drop of ink will rise.	The air in the flask loses heat to the basin of hot water and expands and pushes the drop of ink upwards.
(2)	The drop of ink will rise.	The air in the flask gains heat from the basin of hot water and expands and pushes the drop of ink upwards.
(3)	The drop of ink will drop.	The air in the glass tube contracts and loses heat to the basin of hot water and pushes the drop of ink downwards.
(4)	The drop of ink will drop.	The air in the flask and glass tube expands and gains heat from the basin of hot water and pushes the drop of ink downwards.

21. Mary placed points X and Y of the circuit tester shown below on different points 1, 2, 3, 4 and 5 of a circuit card. She observed if the bulb lit up and recorded her observations:

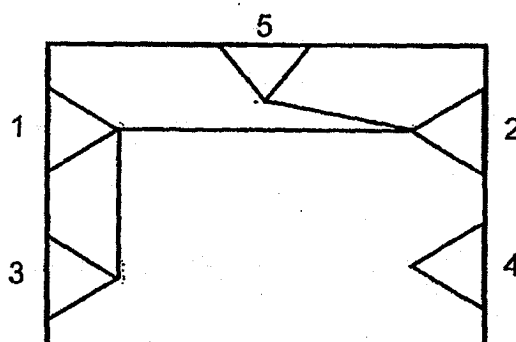
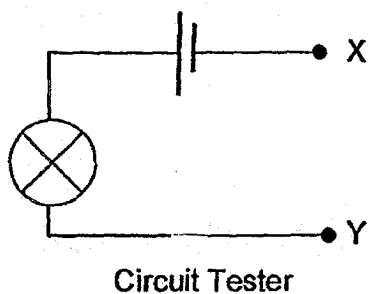

Circuit Card

	Points in contact with circuit tester	Bulb lit up	Bulb did not light up
A	1 and 5	✓	
B	1 and 2		✓
C	3 and 4	✓	
D	5 and 3	✓	

Which of the following are correct observations made by Mary?

- (1) A and D only
- (2) B and C only
- (3) A, C and D only
- (4) A, B and D only

22. The diagram below shows an electrical circuit.

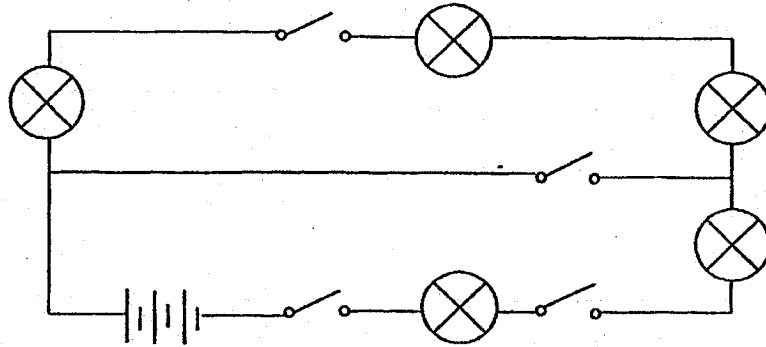

What is the minimum number of switches which need(s) to be closed to light up **only two** bulbs?

- (1) One
- (2) Two
- (3) Three
- (4) Four

23. Adam set up four circuits, P, Q, R and S, using identical batteries, bulbs and wires.

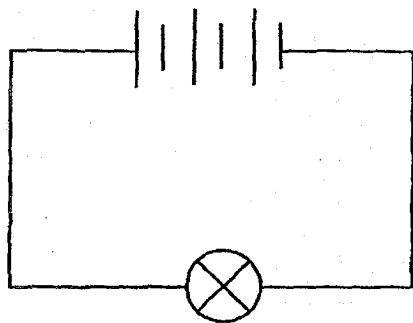

Circuit P

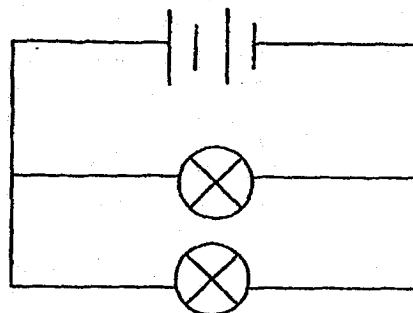

Circuit Q

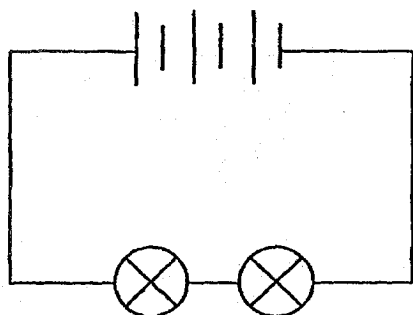

Circuit R

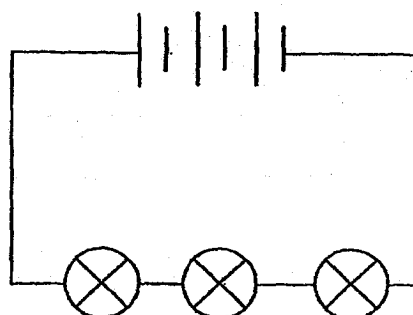

Circuit S

The following statements are made about the circuits above.

- A The bulb in circuit P is the brightest.
- B The bulbs in circuit P and R have the same brightness.
- C The bulbs in circuit Q are brighter than the bulbs in circuit S.
- D The bulbs in circuit S are less bright than the bulbs in circuit R and Q.

Which of the following statements is/are incorrect?

- (1) A only
- (2) B only
- (3) A and B only
- (4) A, C and D only

24. Five bar magnets are placed together and their poles are marked as shown in the diagram below.

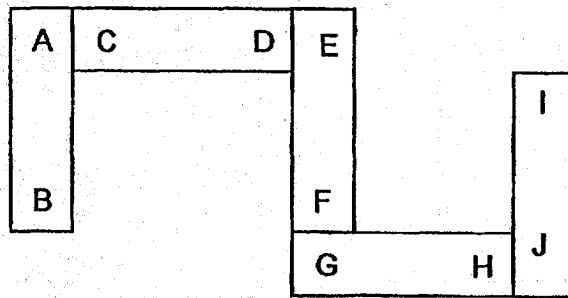

Which of the following diagrams shows the correct interaction when three of the bar magnets from the above set-up are brought close together?

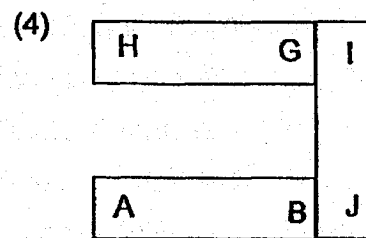
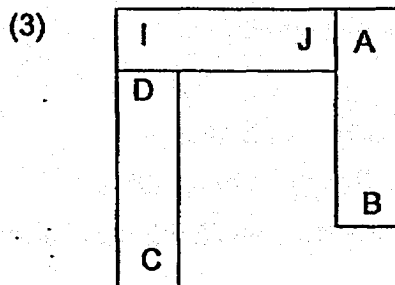
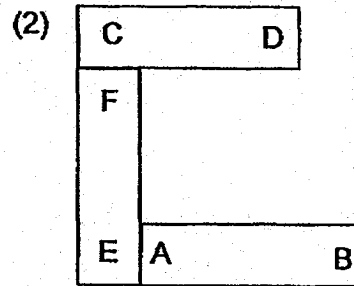
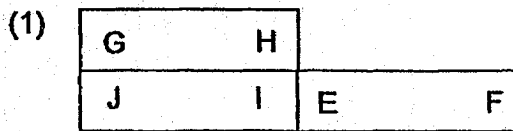

25. Devi hung four objects, A, B, C and D, on a wooden rod. The diagram shows what she observed.

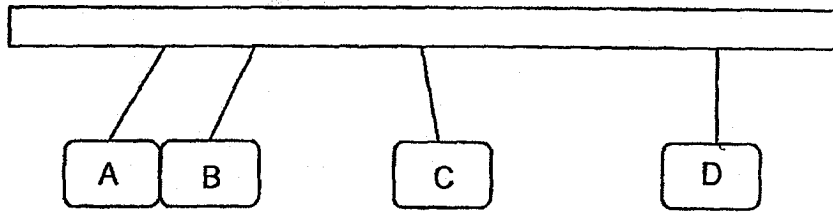

She then exchanged the positions of B and C. The diagram below shows her new observation.

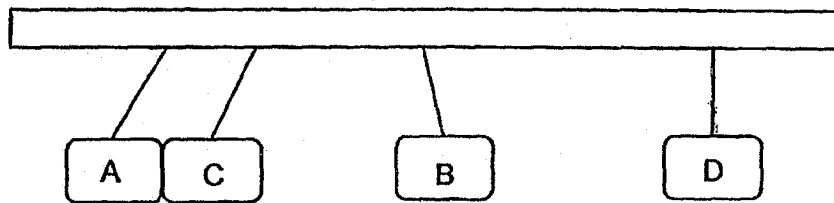

Which of the following correctly describes the objects?

	Object A	Object B	Object C	Object D
(1)	magnetic material	magnetic material	magnetic material	magnet
(2)	magnet	magnet	magnetic material	magnetic material
(3)	magnetic material	magnet	magnet	non magnetic material
(4)	magnetic material	magnetic material	magnet	non magnetic material

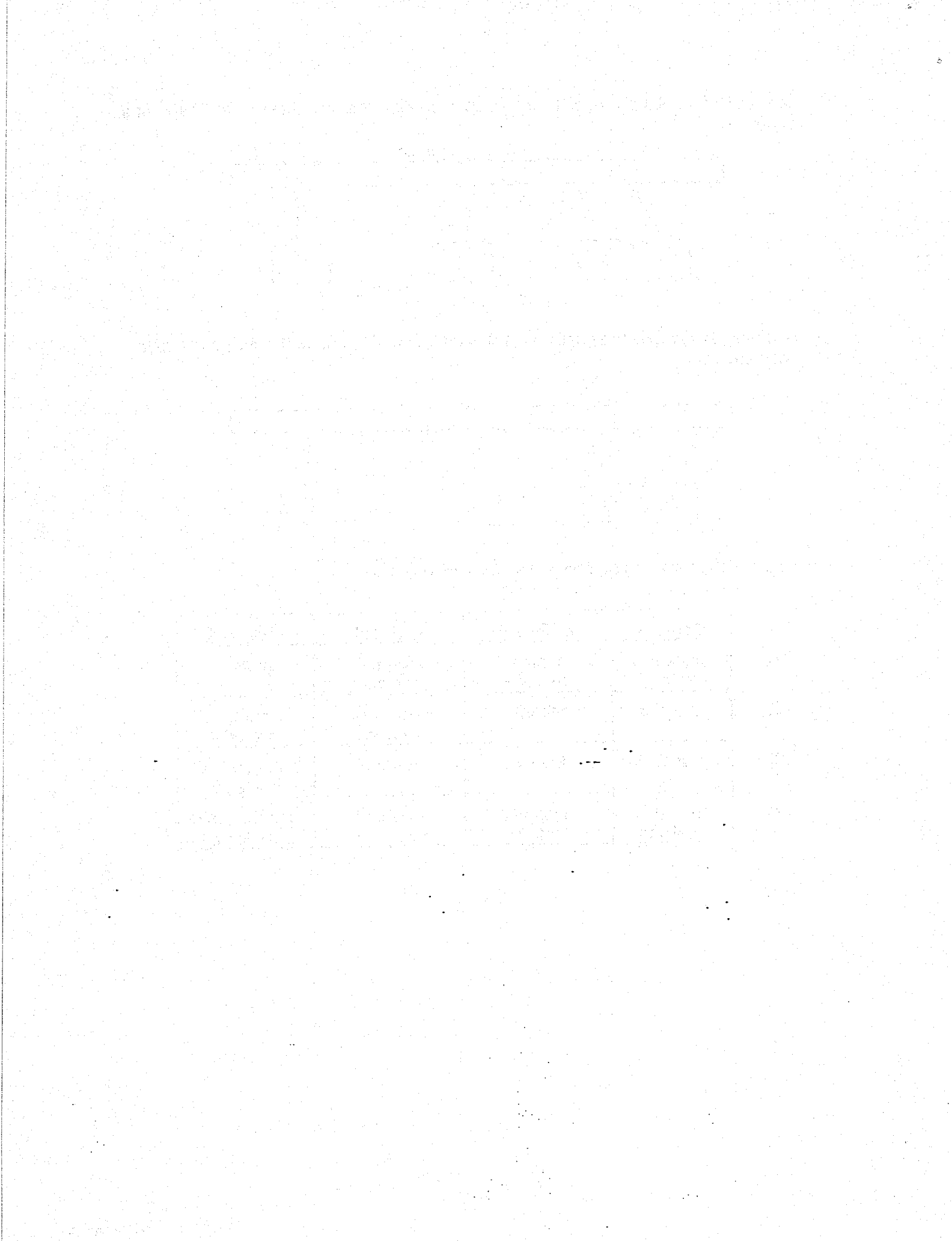

Name: _____ Index No: _____ Class: P5 _____

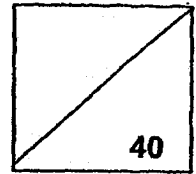

SECTION B (40 marks)

For questions 26 to 38, write your answers clearly in the spaces provided.

The number of marks is shown in brackets [] at the end of each question or part question.

26. The diagram below shows the parts of the plant and female reproductive systems respectively.

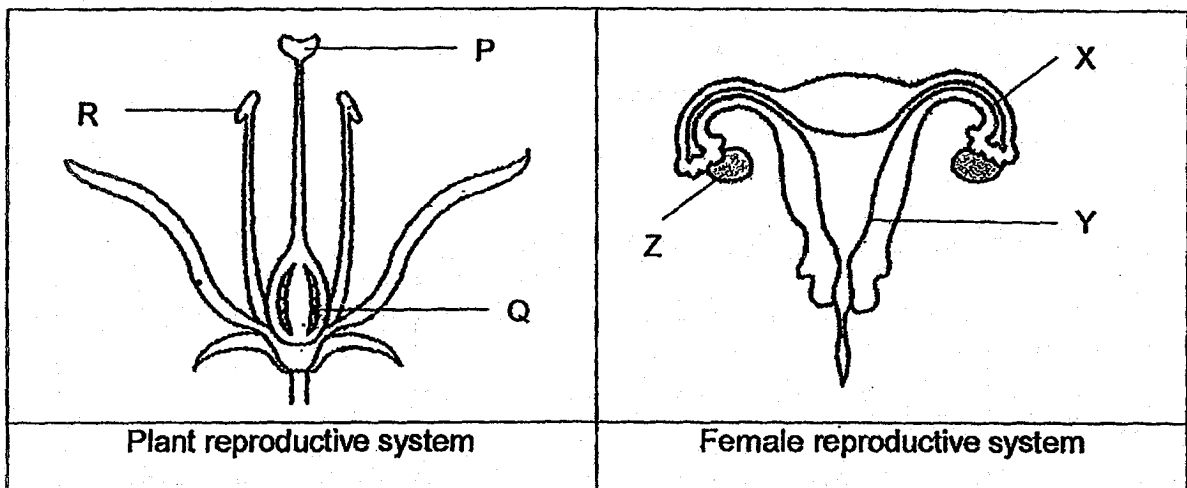

- (a) Identify the part labelled Z and state its function.

- (b) Identify the parts where the male reproductive cell fuses with the female reproductive cell in the plant and female reproductive system respectively. [2]

(i) Plant reproductive system: _____

(ii) Female reproductive system: _____

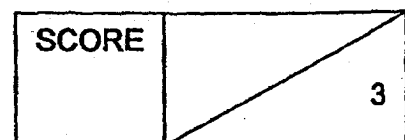

27. Cheryl carried out an experiment using three different types of seeds. She took some seeds of each type, mixed them together and placed them on a table in front of a fan. After some time, she counted the number of each type of seed in each of the sections marked 1, 2 and 3.

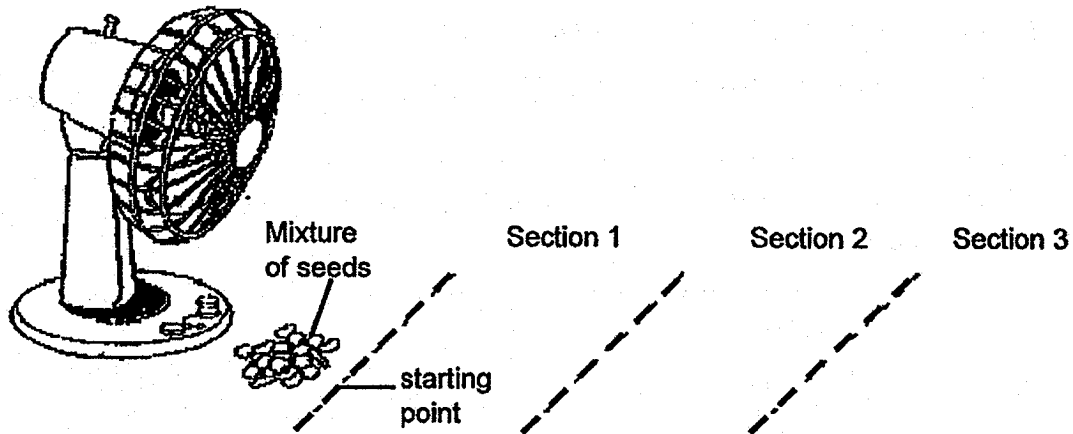

Her results were recorded in the table below.

Type of seeds	Average mass of seed (g)	Number of seeds			
		Number of seeds at starting point	Section 1	Section 2	Section 3
A	1	10	0	1	9
B	1.6	10	2	8	0
C	2.1	10	0	0	0

- (a) Based on the results from the experiment, what is the relationship between the mass of the seed and the distance travelled by the seed? [1]

- (b) Identify the type(s) of seeds that is/are more likely dispersed by wind. [1]

- (c) What should Cheryl do to ensure her results are reliable? [1]

SCORE	3
-------	---

28. Sarah prepared four set-ups, A, B, C and D, using identical plants. The pots are filled with the same type of soil to their brims.

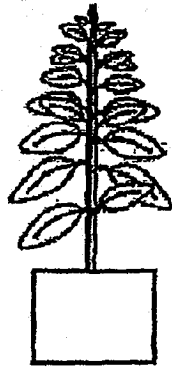

A



aluminium foil covering the mouth of the pot

B

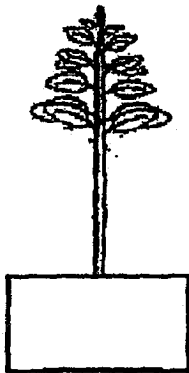

C

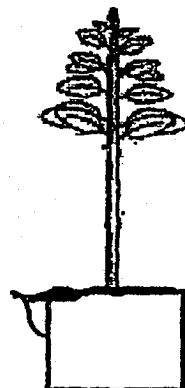

aluminium foil covering the mouth of the pot

D

Sarah wanted to investigate how the number of leaves affected the rate of water loss by the plant over a week.

(a) Which two set-ups should Sarah use to conduct a fair test?

(b) What should Sarah measure in order to find out how the number of leaves affected the rate of water loss by the plant? [1]

SCORE	2
-------	---

Continued from previous page.

(c) What is the purpose of covering the mouth of the pot with an aluminium foil? [1]

29. The diagram below shows a skeletal system.

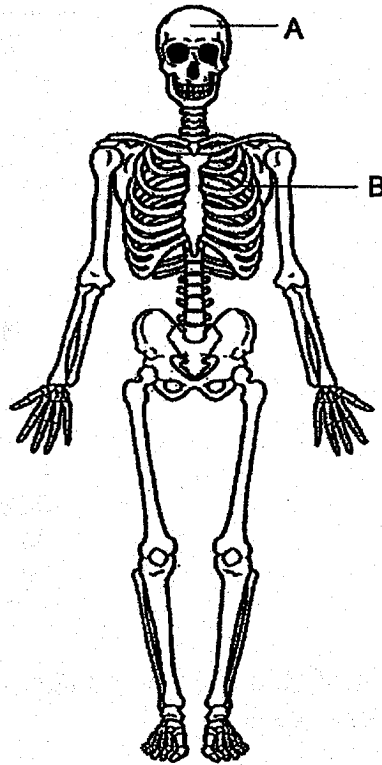

(a) Name the following parts in the skeletal system. [1]

Part A: _____

Part B: _____

(b) State two functions of the skeletal system. [2]

(i) _____

(ii) _____

SCORE	
	4

30. Sam was provided with pictures of two different types of cells as shown below.



Cell A

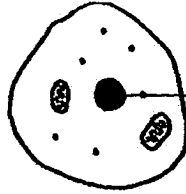

Cell B



(a) Based on the observation above, state two differences that will enable Sam to identify the plant cell. [2]

(b) In the diagram above, label and name the part that carries genetic material in cell B. [1]

31. The flowchart below shows the respiratory system in both fish and humans. Complete the chart by filling in the boxes below using the correct organs. [2]

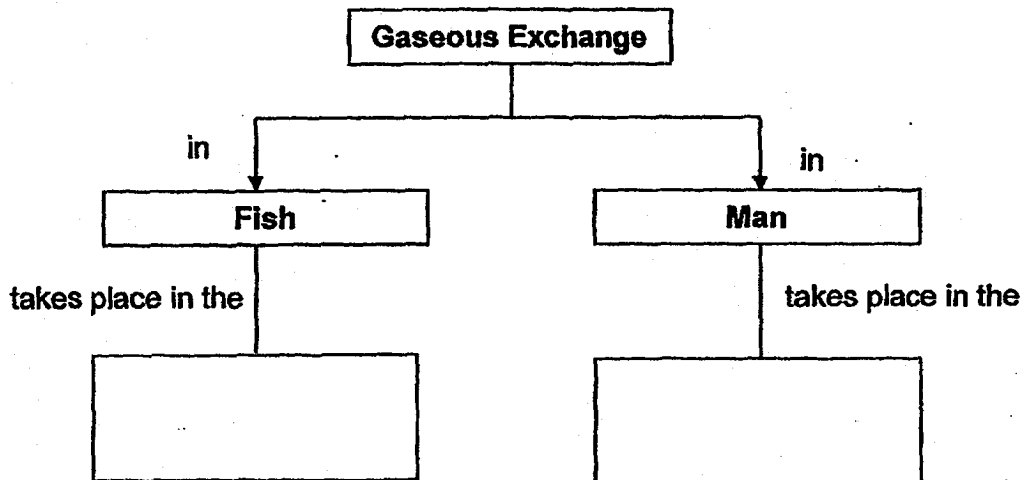

SCORE	5
-------	---

32. The graph below show the breathing rate and heart rate of a man who started running.

Breathing rate

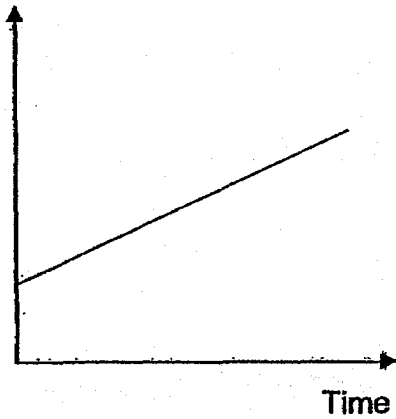

Heart rate

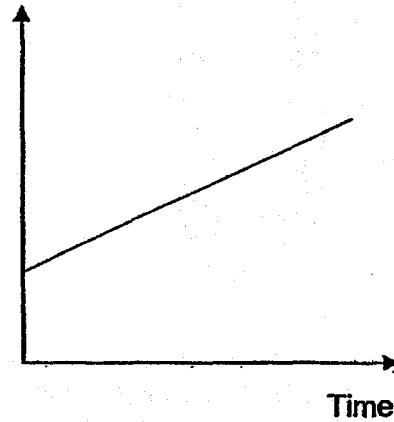

- (a) Based on the graphs above, what is the relationship between the breathing rate and heart rate of the man? [1]

- (b) Explain the increase in his heart rate while he is running. [2]

SCORE	3
-------	---

33. Look at Diagram A as shown below.

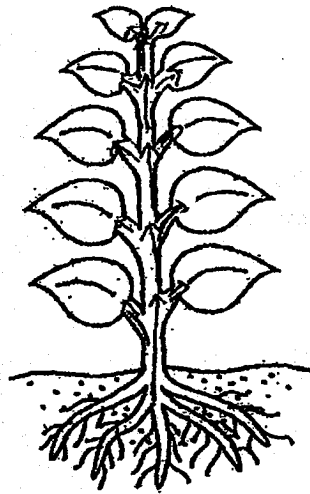

Diagram A

(a) Draw arrows in Diagram A above to show the direction in which water is transported in plant. [1]

Diagram B below shows the transport system of an animal.

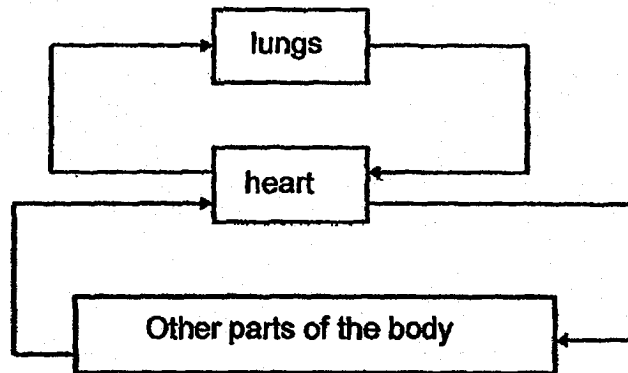
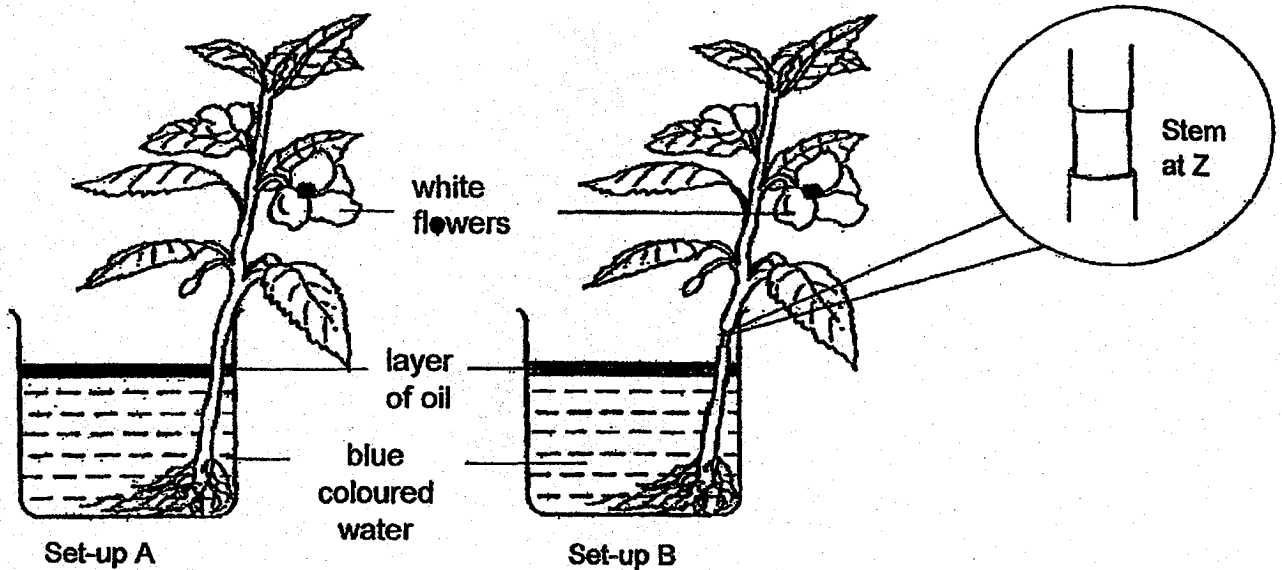

Diagram B

(b) Based on the information in Diagrams A and B, state a difference in the direction between the transport of water in an animal and in a plant. [1]

SCORE	2
-------	---

34. Mary conducted the experiment as shown below. A small ring of the outer layer of the stem in set-up B has been removed.



Both set-ups were placed in an open field. After two days, Mary observed swelling only above the ring of the stem at Z in set-up B as shown below.

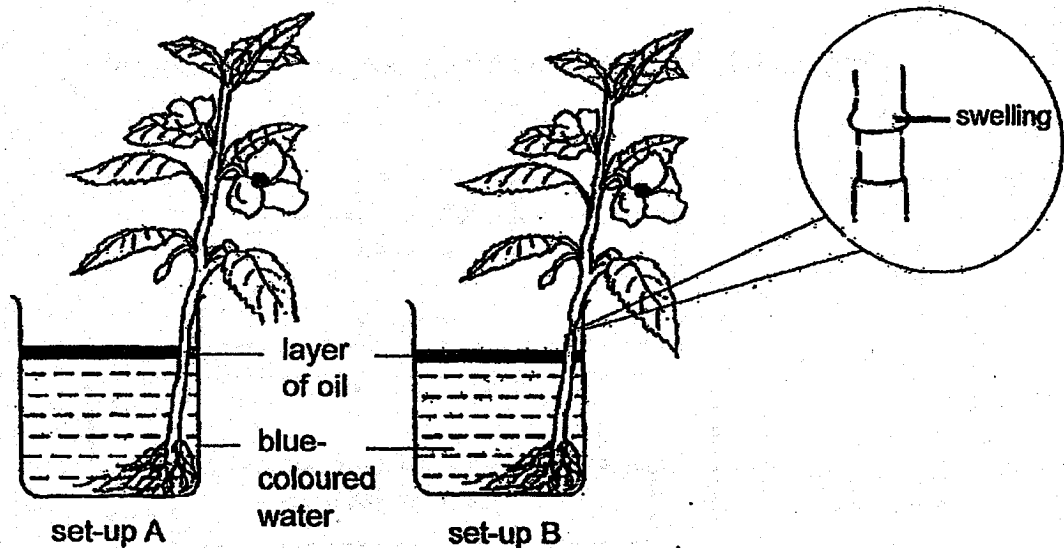

Based on the information above, answer the following questions.

- (a) Explain the presence of the swelling above the ring of the stem in set-up B. [1]

SCORE	1
-------	---

Continue on next page

Continued from previous page

- (b) Would Mary observe any changes to the flowers in both set-ups A and B after two days? Explain your answer. [2]

Tiffany wanted to collect some pure water from the seawater. She set up an experiment using the given apparatus. The diagram below shows her observation after fifteen minutes.

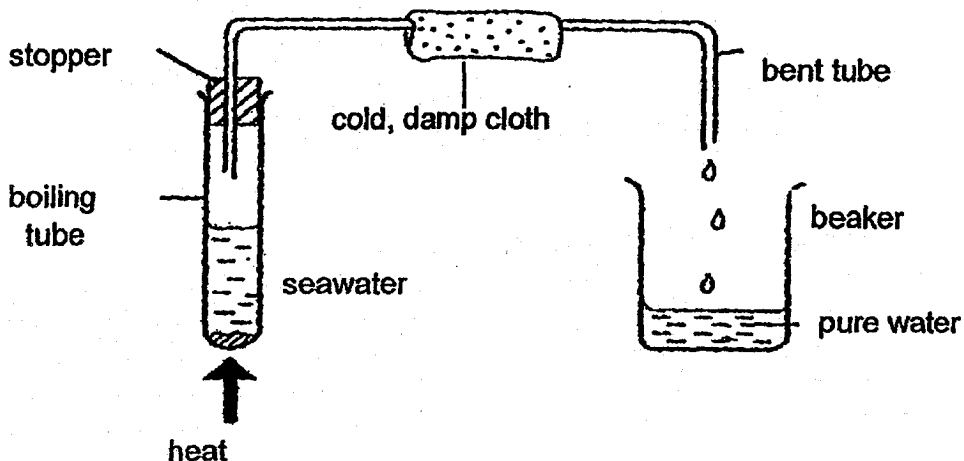

- (a) What would be left in the boiling tube after all the water has been boiled completely? [1]

- (b) What are the two important processes that must have taken place for pure water to be collected? [2]

- (i) _____
(ii) _____

- (c) Suggest two ways she could make to the set-up above in order to collect more water within fifteen minutes of her experiment? [2]

- (i) _____
(ii) _____

SCORE	7
-------	---

36. Fariq used a datalogger to measure the amount of light that passed through different types of materials, D, E and F. The amount of light from the torch is 1000 lux. He set up the experiment in a dark room as shown in the diagram below.

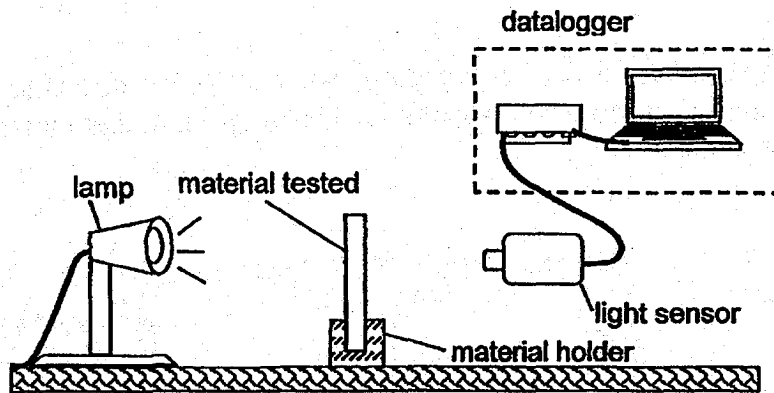

He recorded the results in the table below

Materials	Amount of light detected (lux)
D	750
E	0
F	156

- (a) Based on the results, which material is most suitable to be used to make curtains to block out light completely? Give a reason for your answer. [1]

- (b) Suggest a reason why the amount of light detected by each material is different. [1]

Continue on next page

SCORE	2
-------	---

Continued from previous page

- (c) Fariq added a white opaque card in front of the lamp. What would he observe about the amount of light detected by the light sensor for materials D and F? Explain your answer. [2]

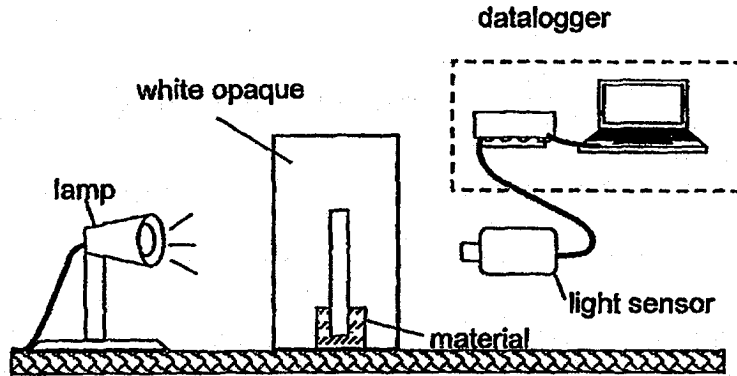

SCORE	2
-------	---

37. Joseph set up an electrical circuit as shown in the diagram below.

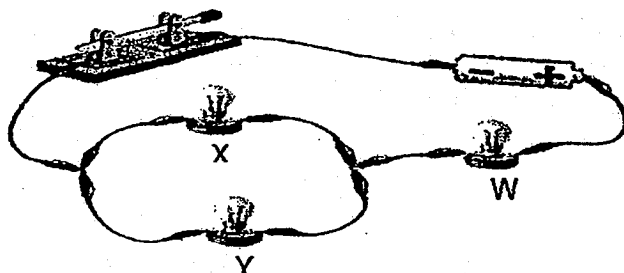

(a) What will Joseph observe if bulb Y fuses? Give a reason for your answer.

[1]

(b) Using all the three bulbs, battery and switch, draw a circuit diagram where the bulbs are rearranged such that they are brighter than the circuit above.

[2]

(c) Joseph observed that the three bulbs became dimmer when he added a bulb to the circuit. Label the additional bulb with the letter "B" on the electrical circuit below to indicate where he placed the bulb.

[1]

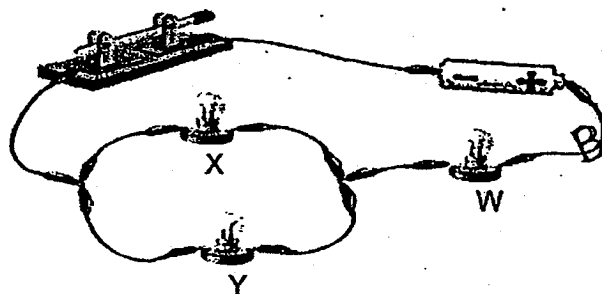

SCORE	4
-------	---

38. Sally's teacher wrapped three objects A, B and C individually with the ends labelled as shown below.



Object A



Object B

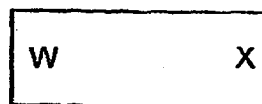

Object C

The three objects are iron rod, copper rod and a magnet.

- (a) Sally used a bar magnet to test and found out that Object B is a magnet. What observations should be made to confirm that object B is a magnet? [1]

- (b) Using only the three objects given above, what can Sally do to find out if object A is an iron rod? [1]

SCORE	2
-------	---

END OF PAPER

SCHOOL : RAFFLES GIRLS' PRIMARY SCHOOL
LEVEL : PRIMARY 5
SUBJECT : SCIENCE
TERM : 2018 SA2

SECTION A

Q 1	Q2	Q3	Q4	Q5	Q6	Q7	Q8	Q9	Q10
3	1	1	4	2	1	3	3	3	4
Q 11	Q12	Q13	Q14	Q15	Q16	Q17	Q18	Q19	Q20
2	1	3	2	1	2	1	4	3	2
Q 21	Q22	Q23	Q24	Q25					
1	3	2	2	3					

SECTION B

Q26)	<p>a) It is the ovary. It produces female reproductive cells and releases the female reproductive cells to the womb.</p> <p>b) i. Q ii. X</p>
Q27)	<p>a) As the mass of the seed is lesser, the distance travelled by the seed is further.</p> <p>b) Seeds A and B.</p> <p>c) She should repeat the experiment a few times and calculate the average.</p>
Q28)	<p>a) Set-up B and D.</p> <p>b) Measure the mass of the potted plant at the beginning and the end of the week.</p> <p>c) It is to prevent the water from evaporating and ensuring it is a fair test for the water will not escape.</p>

Q29)	<p>a) Part A → Skull, Part B → ribcage</p> <p>b) i. to give the body its shape</p> <p>ii. to protect the organs in the body like the heart and the lungs</p>
Q30)	<p>a) The plant cell has a cell wall and large vacuole but an animal cell does not have both</p> <p>b) Nucleus.</p>
Q31)	Fish → Gills, Man → lungs
Q32)	<p>a) As the breathing rate of the man increases, the heart rate of a man also increases.</p> <p>b) Any activity that is vigorous, more energy is needed at the cells so the heart will pump faster so more blood can deliver more oxygen and digested food to cells for respiration to release more energy.</p>
Q33)	<p>a)</p> <div data-bbox="507 938 815 1255" data-label="Image"> </div> <p>b) The plant only has the water and food going in one direction where as the human has water transported with double circulation.</p>
Q34)	<p>a) The food that was made by the leaves needs to be transported to all parts of the plant but the food-carrying tubes were cut off. Thus the food was stored there.</p> <p>b) Both flowers turn blue. The xylem is still intact so blue water absorbed by the roots can be still transported.</p>
Q35)	<p>a) Salt.</p> <p>b) i. evaporation</p> <p>ii. condensation</p> <p>c) i. make the flame bigger</p> <p>ii. increase surface area of the container</p>

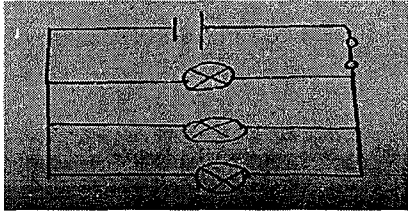
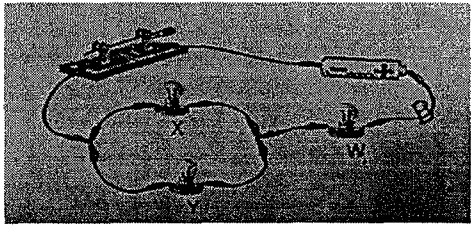
Q36)	<p>a) E. The amount of light detected was zero which shows that it is an opaque material.</p> <p>b) They are made of different materials and might be transparent, translucent or opaque.</p> <p>c) Zero lux. Light cannot pass through opaque things and it is surrounding the material.</p>
Q37)	<p>a) The other light bulbs are still up. It is still a closed circuit and allow electricity to flow through it.</p> <p>b)</p>  <p>c)</p> 
Q38)	<p>a) Either end R or end S of object B should repel with one end of the magnet to confirm that object B is a magnet.</p> <p>b) Observe if a magnet is attracted to A.</p>

