



**HENRY PARK PRIMARY SCHOOL
PRELIMINARY EXAMINATION 2021**

PRIMARY 6

SCIENCE

SECTION A (56 MARKS)

INSTRUCTIONS TO CANDIDATES

1. Do not turn over this page until you are told to do so.
2. Follow all instructions carefully.
3. Answer all questions.
4. Shade your answers on the Optical Answer Sheet (OAS) provided.

Name: _____

Class: Primary 6

Date: 24 August 2021

Total Time for Booklets A and B: 1 h 45 min

Sections	Marks
A	/ 56
B	/ 44
Total	/ 100

Parent's Signature: _____

Booklet A (56 marks)

For each question from 1 to 28, four options are given. One of them is the correct answer.

Make your choice (1, 2, 3 or 4) and shade the correct oval (1, 2, 3 or 4) on the Optical Answer Sheet.

1. Study the classification table below.

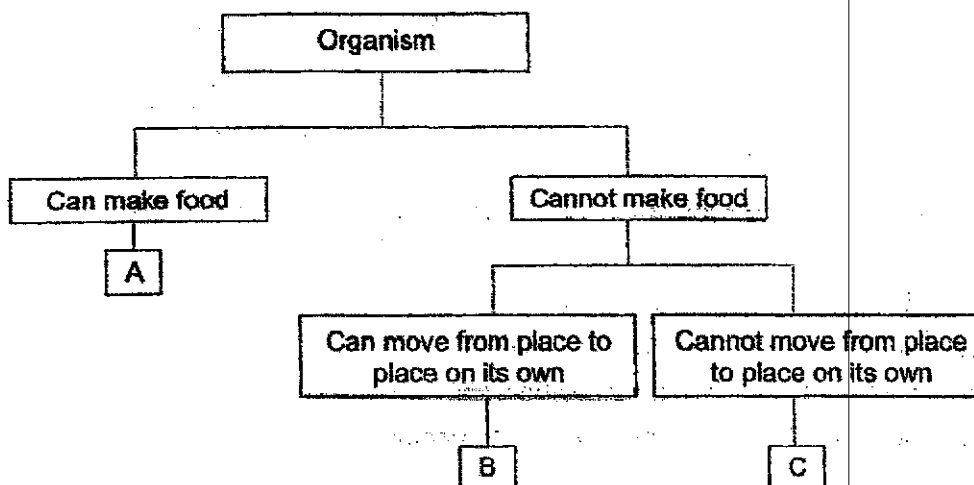

Which of the following are A, B and C most likely to be?

	A	B	C
(1)	Ladder fern	Bread mould	Caterpillar
(2)	Bread mould	Ladder fern	Bacteria
(3)	Ladder fern	Caterpillar	Bread mould
(4)	Bread mould	Bacteria	Ladder fern

2. Study the diagrams of the three different types of cells shown below.

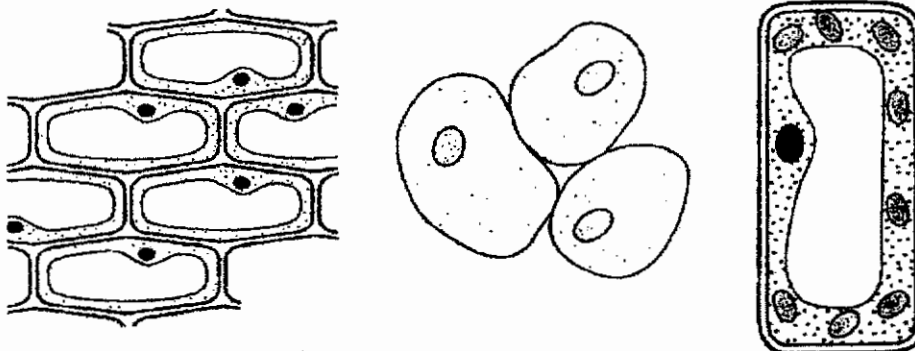

Which of the following parts are present in all the three types of cells shown above?

- (1) nucleus, cytoplasm and cell wall
- (2) nucleus, chloroplast and cytoplasm
- (3) nucleus, cell membrane and cytoplasm
- (4) nucleus, cell wall, cell membrane and cytoplasm

3. The diagrams show different types of fruits and seeds with their characteristics.

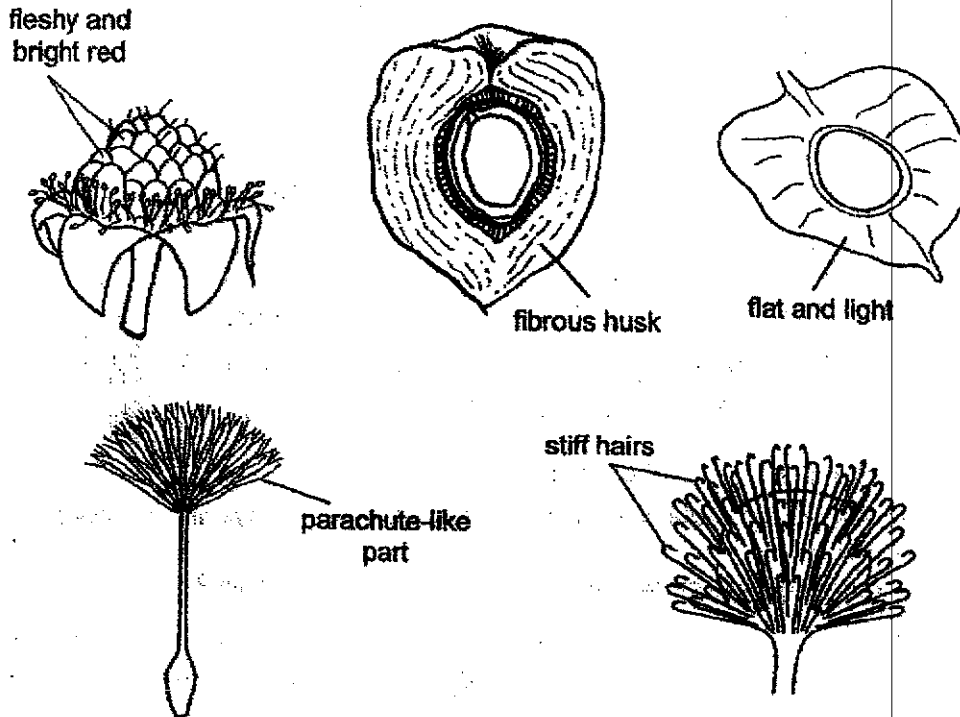

Based on the information given, which of the following shows the correct number of fruits and seeds dispersed according to the methods of dispersal given?

(1)	By animal 1	By water 1	By wind 3
(2)	By animal 3	By water 1	By wind 1
(3)	By animal 1	By water 2	By wind 2
(4)	By animal 2	By water 1	By wind 2

4. Jasper conducted an experiment to find out if plants take in water through their roots as shown in the diagrams below. He covered the roots of the plant in set-up B with a plastic bag.

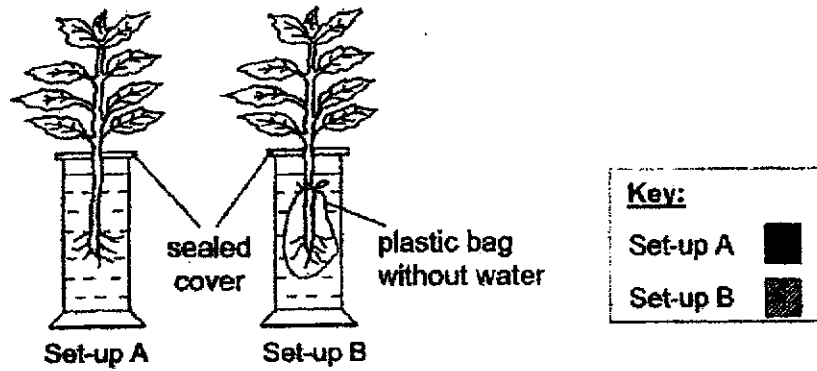

He measured the amount of water in each set-up every day for six days and recorded his results in a graph.

Which of the following graphs shows the amount of water after six days?

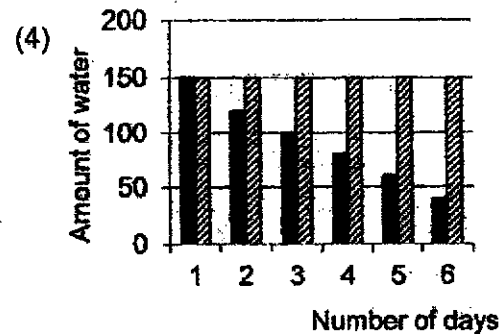
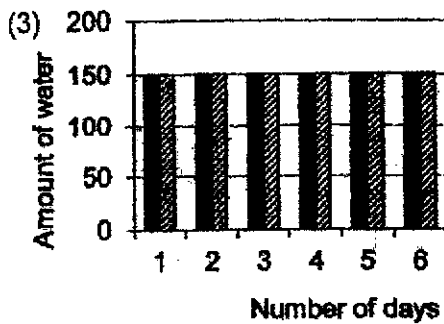
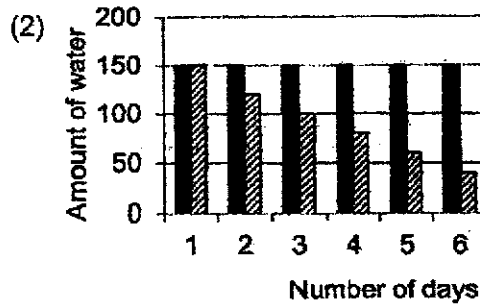
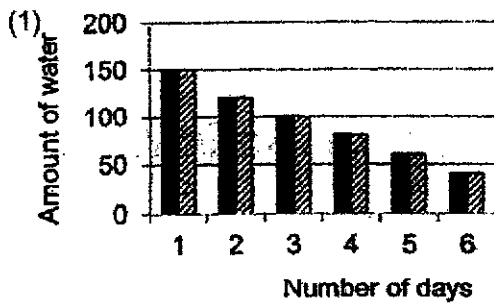

5. Xiachui observed two animals, X and Y, and recorded her observations in the table below.

Observation	Animal X	Animal Y
Has a 3-stage life cycle	✓	x
Spends some stages of its life cycle in water	✓	x
Adult has wings	x	✓

Key:
 ✓ : Yes
 x : No

Which of the following correctly identifies animals X and Y?

	Animal X	Animal Y
(1)	frog	butterfly
(2)	mosquito	cockroach
(3)	frog	grasshopper
(4)	grasshopper	cockroach

6. The following processes A, B, C and D take place in the various parts of the digestive system during digestion.

- A: Undigested food is stored here to be passed out.
- B: Food is digested and absorbed into the blood stream.
- C: Saliva is produced to break down food.
- D: Partially digested food is pushed down the muscular tube.



Which of the following shows the correct order of the processes occurring during digestion?

- (1) D→C→B→A
- (2) D→C→A→B
- (3) C→D→A→B
- (4) C→D→B→A

7. The diagram shows the movement of carbon dioxide in our environment.

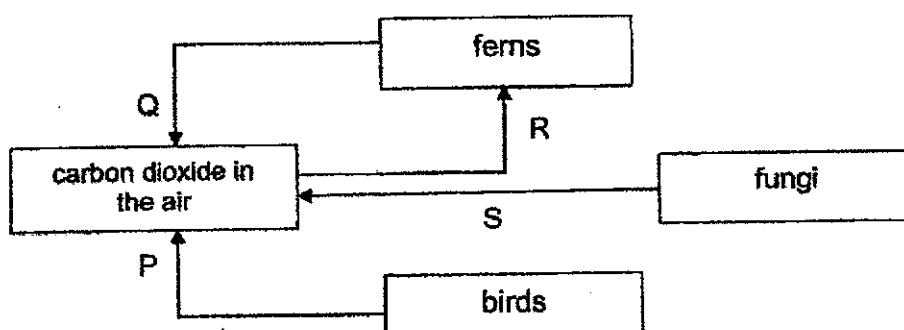

Which one of the following represents photosynthesis?

- (1) P
- (2) Q
- (3) R
- (4) S

8. Gary removed the outer ring of the stem of a plant as shown in Figure A. He left the plant under the sun and watered it regularly. After a few days, he observed that the plant was alive and part of the stem above the ring was swollen as shown in Figure B.

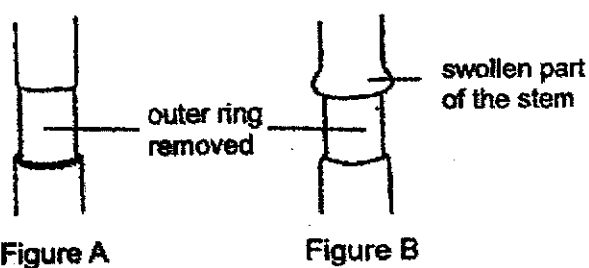

Which of the following statements best explains his observation?

- (1) Food travelling up the stem is trapped above the ring.
- (2) Water travelling up the stem is trapped above the ring.
- (3) Food travelling down the stem is trapped above the ring.
- (4) Water travelling down the stem is trapped above the ring.

9. The diagram shows the upper and lower surfaces of a leaf from plant M after Bella had placed it into hot water.

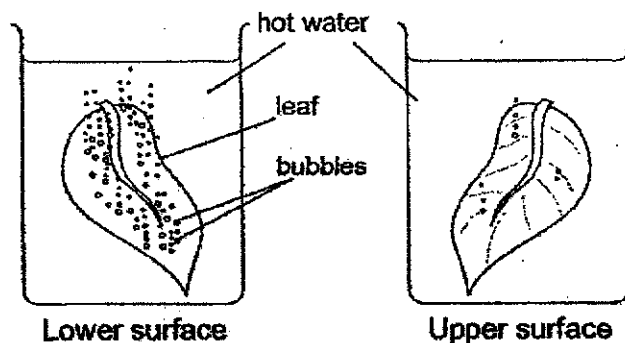

Bella investigated the amount of water loss from the upper surface and the lower surface of a leaf. She applied a thin layer of oil on some surfaces of the leaves taken from plant M. The leaves were hung for 48 hours as shown below.

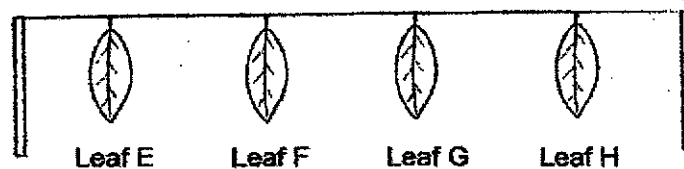

The graph shows the amount of water loss by the four leaves.

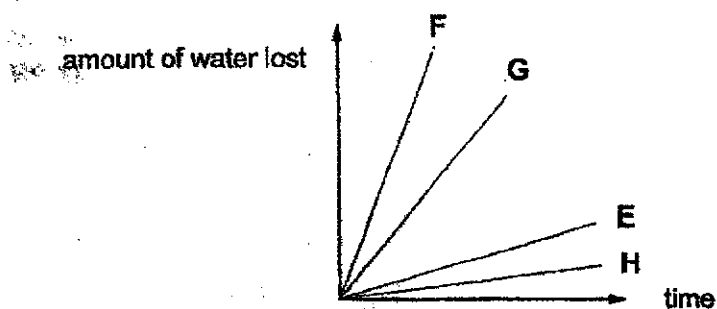

Based on the results, which of the following shows the correct experimental set-up?

	oil on both surfaces	oil on upper surface only	oil on lower surface only	no oil on any surface
(1)	leaf H	leaf G	leaf E	leaf F
(2)	leaf F	leaf G	leaf E	leaf H
(3)	leaf H	leaf E	leaf G	leaf F
(4)	leaf F	leaf E	leaf G	leaf H

10. Which one of the following diagrams of a flower is correctly labelled?

(1)

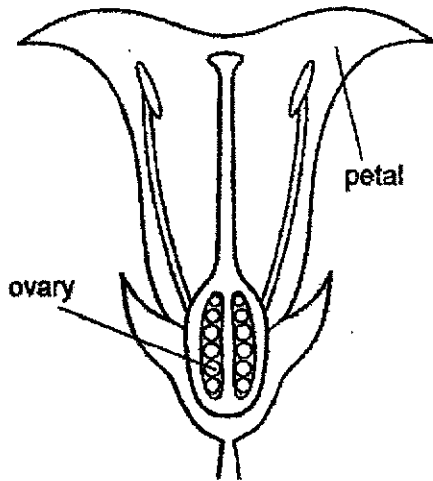

(2)

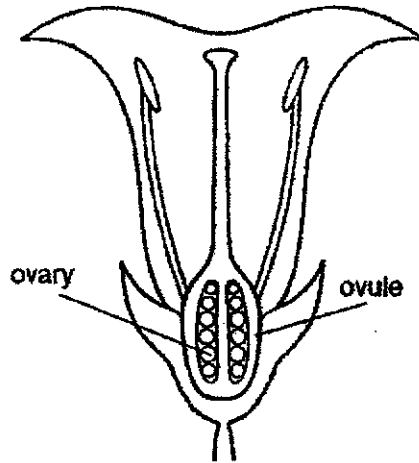

(3)

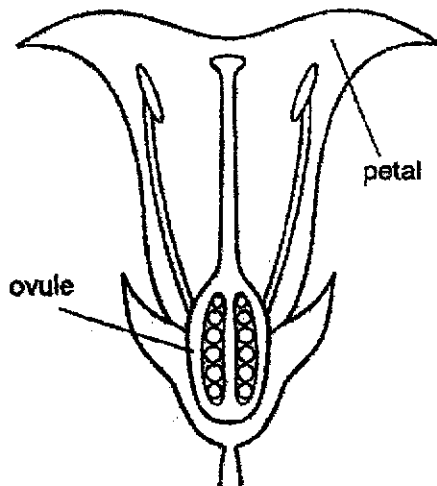

(4)

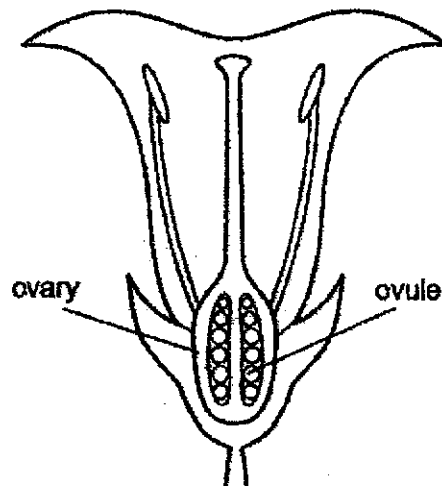

11. The diagrams below show the reproductive systems of a human and a plant.

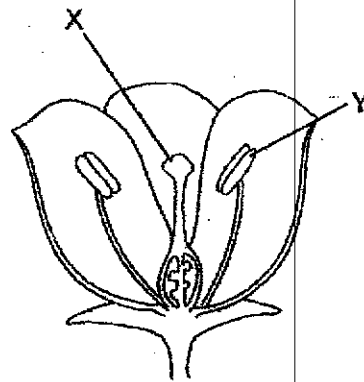
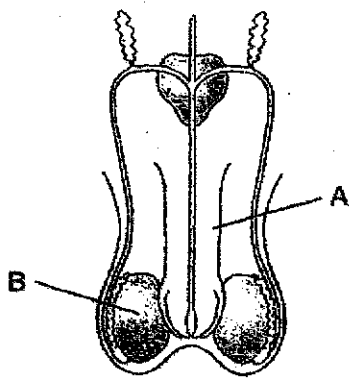

Which of the following represents the parts involved in producing the male reproductive cells?

- (1) A and X
- (2) B and Y
- (3) A and Y
- (4) B and X

12. Margaret set up three glass jars as shown in the diagram. She measured and recorded the amount of carbon dioxide in each glass jar.

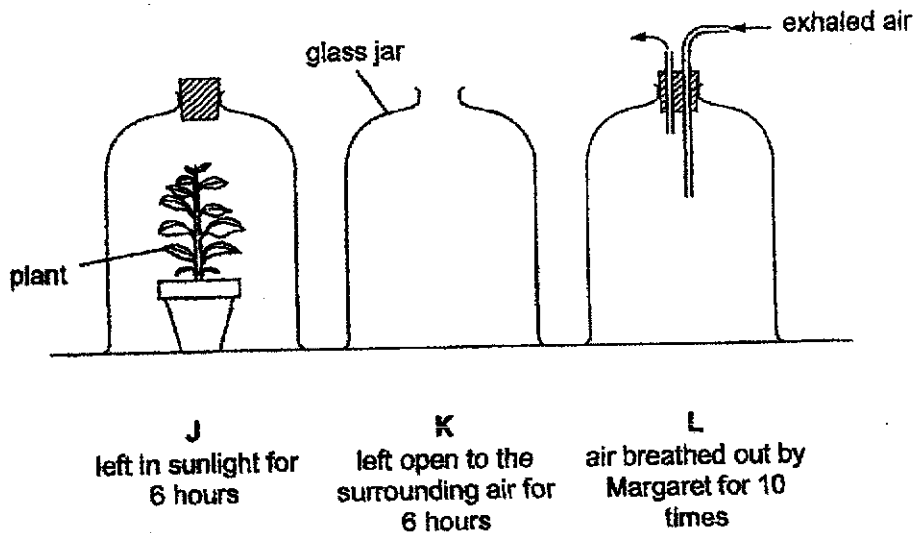

At the end of the experiment, which glass jar has the most amount of carbon dioxide and which has the least amount?

	most amount of carbon dioxide	least amount of carbon dioxide
(1)	J	K
(2)	J	L
(3)	L	J
(4)	L	K

13. In flowering plants, process P occurs when pollen grains are transferred from the anther to the stigma as shown by the arrow in the diagram below.

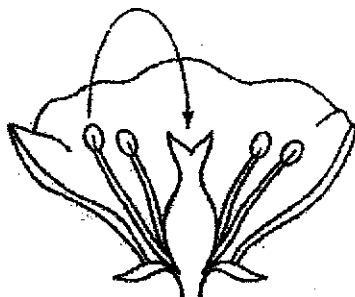

The following statements describe the various stages that happen next.

- W The pollen grain grows a pollen tube.
- X The pollen tube enters the ovule.
- Y The pollen tube grows down the style.
- Z Male reproductive cell fuses with an egg cell.

In which order do these stages occur?

- (1) W → X → Z → Y
- (2) W → Y → X → Z
- (3) X → Y → W → Z
- (4) Y → W → Z → Y

14. The diagram shows a mobile phone connected to a solar-powered charger.

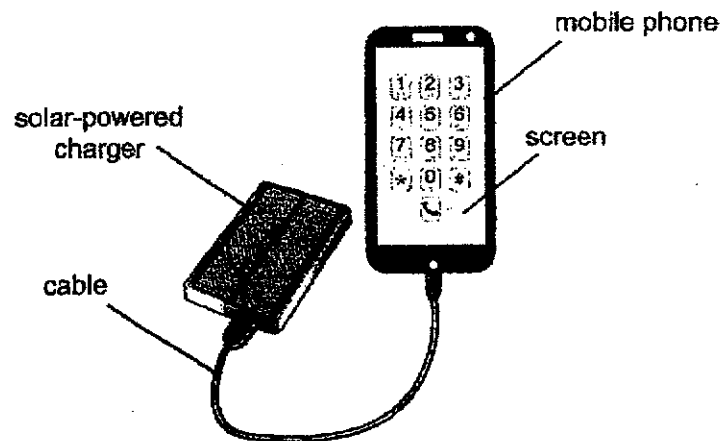

The charger transfers light energy from the Sun to the battery of the mobile phone. Which of the following shows a part of the energy conversion correctly?

- (1) potential energy (in the charger and the cable) → potential energy (in the battery of the mobile phone)
- (2) solar energy (in the charger and the cable) → electrical energy (in the battery of the mobile phone)
- (3) electrical energy (in the charger and the cable) → light energy (in the battery of the mobile phone)
- (4) electrical energy (in the charger and the cable) → potential energy (in the battery of the mobile phone)

15. The table shows the state of four different substances, W, X, Y and Z, at different temperatures.

Substance	State of substance		
	at 5°C	at 40°C	at 90°C
W	liquid	liquid	gaseous
X	solid	liquid	liquid
Y	liquid	gaseous	gaseous
Z	solid	solid	solid

Which substance has the lowest boiling point?

- (1) W
- (2) X
- (3) Y
- (4) Z

16. Mr Li set up the experiment shown below to find out which substance, air or water, will push the stopper to a greater height when heated.

He heated a flask over a strong flame and recorded the height the stopper reached. Next, he repeated the experiment with an identical flask completely filled with water.

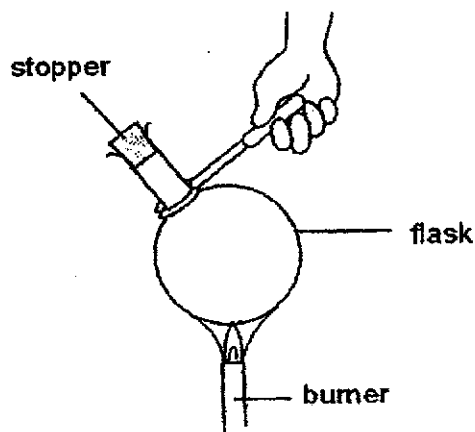

The table below shows the results of his experiment.

Substance in flask	Height reached by stopper /cm		
	Trial 1	Trial 2	Average
Air	15	17	16
Water	5	3	4

Which of the following statements explain(s) his observations above?

- A Air conducted heat faster than water.
- B Water expands less than air when heated.
- C The flask with water expanded more than the one with air when heated.

- (1) A only
- (2) B only
- (3) A and C only
- (4) A, B and C

17. Opaque objects P, Q and R were placed in a straight line at positions X, Y or Z, between the screen and the light source as shown in the diagram below.

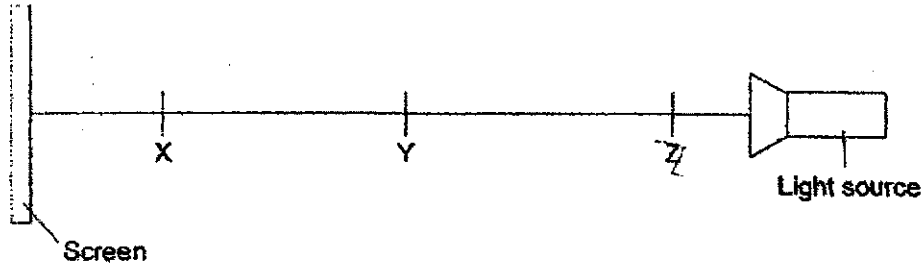

The dimensions and shapes of objects P, Q and R when viewed from the front are as shown below.

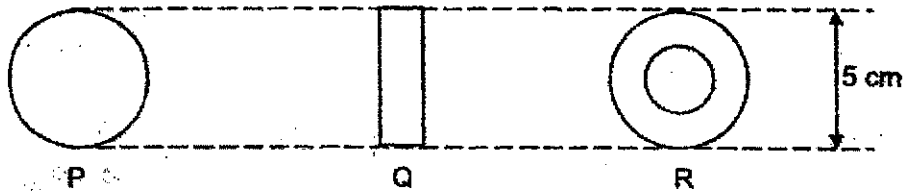

The shadow formed on the screen is shown below.



Which of the positions X, Y or Z should objects P, Q and R be placed in order to form the shadow as shown above?

	Position X	Position Y	Position Z
(1)	P	Q	R
(2)	Q	P	R
(3)	Q	R	P
(4)	P	R	Q

18. Similar balls of different materials, A, B and C, were placed in liquids X and Y. The balls stayed at the positions as shown below.

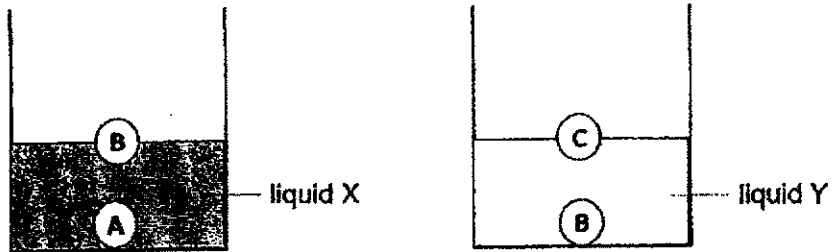

Liquid X and Y do not mix. When they were poured into a container, liquid Y floated on top of liquid X.

If similar balls of materials A, B and C were added to this container, which one of the following diagrams would show the correct positions?

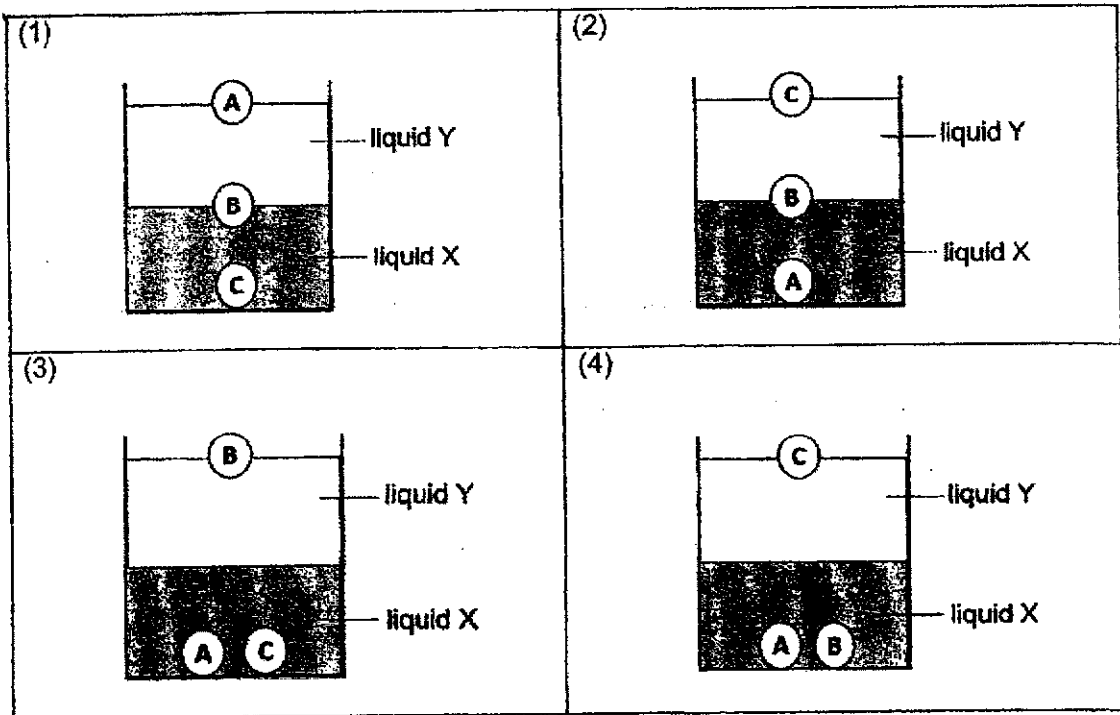

19. Lisa tested the strength of materials, A, B, C and D, by dropping a 2 kg weight from a height using the set-up as shown below. The materials were of the same size, thickness and shape.

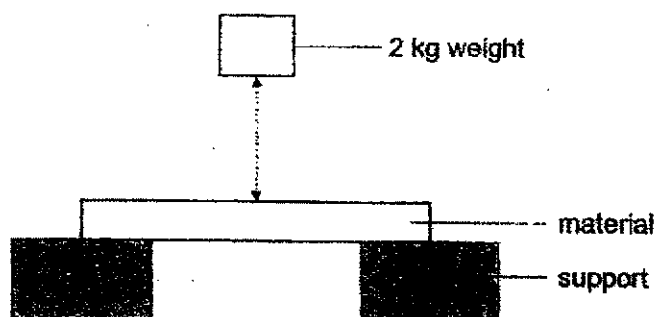

She noted the number of times the weight was dropped before the materials broke. Her results are shown in the table below.

Material	Number of drops before the material broke
A	10
B	15
C	21
D	8

Based on the results in the table above, which of the following conclusions is correct?

- (1) Material A is the least strong.
- (2) Material D is the strongest material.
- (3) Material C is stronger than material B.
- (4) Material D is stronger than material C.

20. Four metal pins A, B, C and D were fixed onto a wooden board as shown below. Figure 2 shows two batteries and a bulb connected to two wires X and Y.

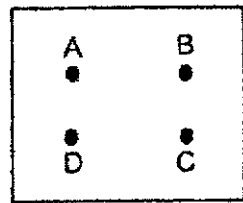

Figure 1

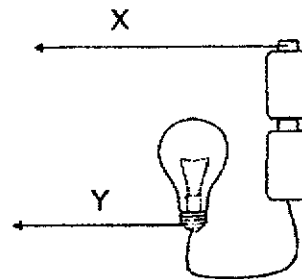

Figure 2

Ravi connected some but not all the pins with wires. He then connected X and Y across different pairs of pins. He recorded his results in the table below.

Pin connected to X	Pin connected to Y	Did the bulb light up?
A	B	Yes
B	C	No
C	D	No
D	A	Yes

Which one of the following correctly shows the connections tested by Ravi?

<p>(1)</p>	<p>(2)</p>
<p>(3)</p>	<p>(4)</p>

21. Mary conducted an experiment to investigate elastic spring force. She hung a spring from a beam and attached a heavy wooden block to the spring as shown below.

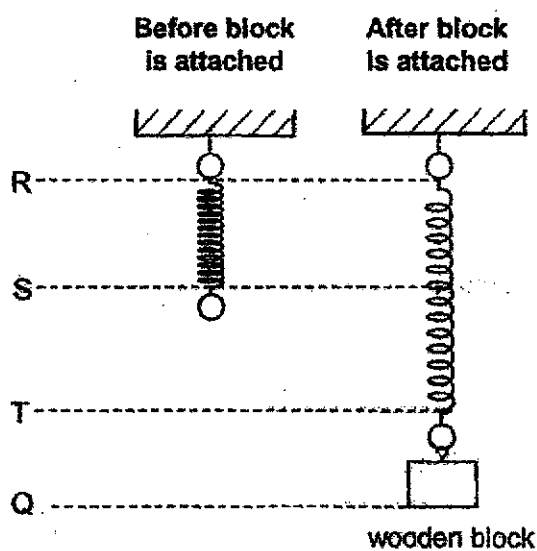

She wanted to measure the extension of the spring and determine the direction of the force exerted on the wooden block by the spring.

Based on the information given, which of the following is correct?

	Parts to be measured to find the extension of the spring	Direction of force exerted on the wooden block by the spring
(1)	from S to Q	↑
(2)	from S to T	↑
(3)	from S to T	↓
(4)	from R to T	↑

22. Yasmin set up an experiment as shown in the diagram below.

When released, the trolley moves down the ramp and hits the block causing it to move.

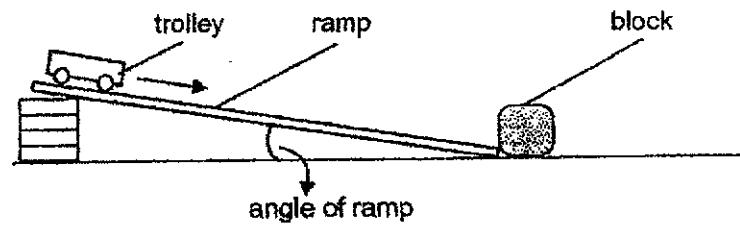

Distance y refers to the distance moved by the block when the trolley hits it as shown in the diagram below.

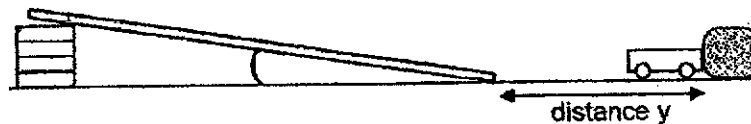

Yasmin wanted to investigate how different variables in the above set-up affect distance y .

Based on the experimental set-up given, which of the following is not correct?

	Change to the experimental set-up	Change in distance y observed
A	reduce the mass of the block	decrease
B	increase the mass of the trolley	decrease
C	increase the angle of the ramp	increase

- (1) A and B only
- (2) B and C only
- (3) A and C only
- (4) A, B and C

23. Michael hits a moving rubber ball as shown below.



Which of the following changes could happen to the ball when it is hit?

- A A change in mass
- B A change in speed
- C A change in direction

- (1) A and B only
- (2) B and C only
- (3) A and C only
- (4) A, B and C

24. Jovan carried out an experiment using a set-up as shown below to find out if the presence of wind affects the rate of evaporation of water.

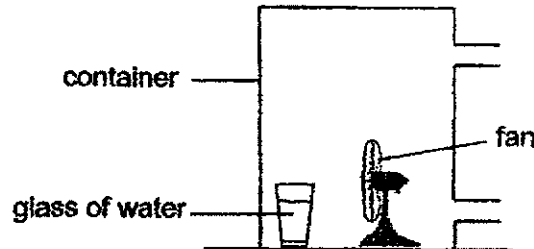

Which of the following should he use as a control set-up?

<p>(1)</p>	<p>(2)</p>
<p>(3)</p>	<p>(4)</p>

25. An ice cube is taken from a freezer and is placed on a wooden table at room temperature to melt as shown in the diagram below.

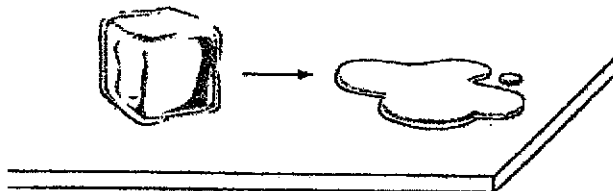

Which of the following shows the correct energy transfer taking place during the melting of ice and immediately after the ice has completely melted?

Energy transfer		
	when ice is melting	after ice has melted completely
(1)	from the ice cube to the surrounding	from the water to the surrounding
(2)	from the surrounding to the ice cube	from the water to the surrounding
(3)	from the ice cube to the surrounding	from the surrounding to the water
(4)	from the surrounding to the ice cube	from the surrounding to the water

26. Jenny arranged three similar iron bars, X, Y and Z, on a wooden table as shown below.

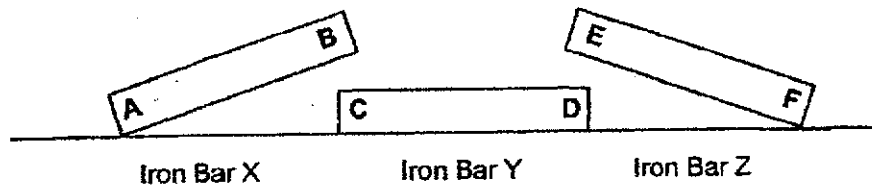

Jenny brought ends of different iron bars together and observed what happened.

Based on the information given, which of the following is likely to be observed?

	Ends that repel	Ends that attract
(1)	A and D	B and F
(2)	B and F	C and F
(3)	B and E	A and C
(4)	C and F	B and D

27. Diagram 1 shows Tom skydiving in a wingsuit.

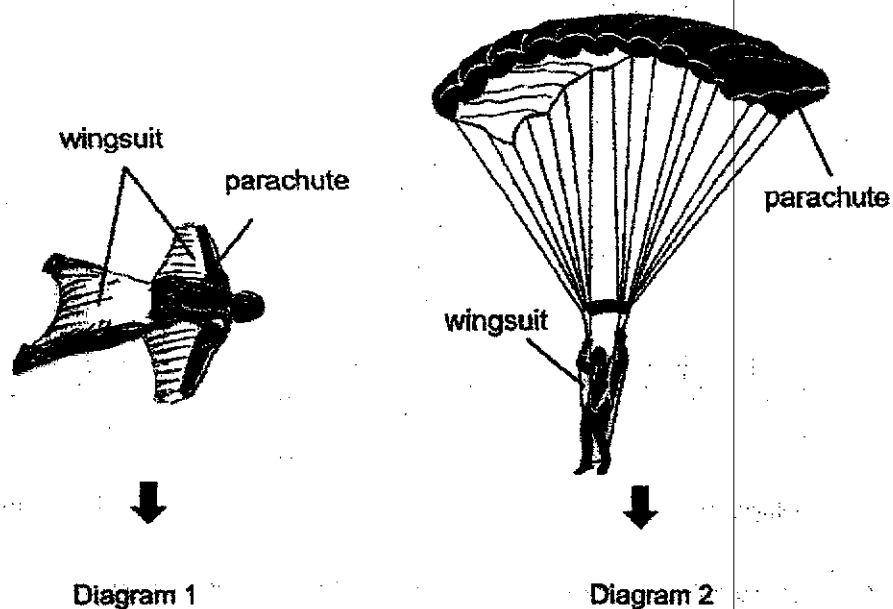

After some time, to avoid serious injuries from the fall, Tom opened up a parachute, as shown in diagram 2.

The following statements show the information about Tom's skydiving experience.

- A In diagram 1, Tom falls faster.
- B In diagram 1, Tom experiences more air resistance.
- C In diagram 2, more weight is exerted on Tom.
- D In diagram 2, Tom experiences more air resistance.

Which of the above statements are correct?

- (1) A and B only
- (2) A and D only
- (3) B and C only
- (4) A, C and D only

28. A magnet is placed on an electronic balance as shown in diagram 1.

The reading on the electronic balance changes when another magnet or an iron bar is held close to the first magnet as shown in the diagrams below.

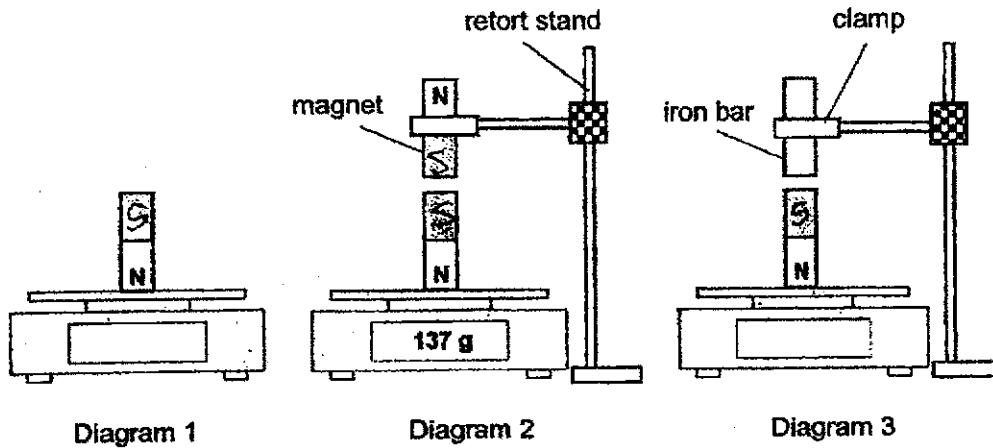

Which of the following shows the likely readings in diagrams 1 and 3?

Electronic balance reading (g)	
Diagram 1	Diagram 3
(1) 90	less than 137
(2) 90	more than 137
(3) 150	less than 137
(4) 150	more than 137

End of Booklet A



**HENRY PARK PRIMARY SCHOOL
PRELIMINARY EXAMINATION 2021**

PRIMARY 6

SCIENCE

SECTION B (44 MARKS)

INSTRUCTIONS TO CANDIDATES

1. Do not turn over this page until you are told to do so.
2. Follow all instructions carefully.
3. Answer all questions.

Name _____

Class: _____

Date: 24 August 2021

Total Time for Booklets A and B: 1 h 45 min

Marks for Section B: _____

Booklet B (44 marks)

For questions 29 to 40, write your answers in this booklet.

The number of marks available is shown in brackets [] at the end of each question or part question.

29. Sheryl had two similar pieces of bread, A and B. She wanted to find out how different amounts of water would affect the growth of bread mould.

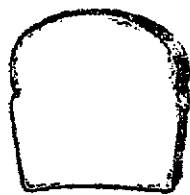

Bread A

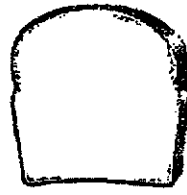

Bread B

- (a) In the table below, tick (✓) the variable(s) that Sheryl should keep the same at the start of the experiment. [1]

Tick (✓)	Variable
	size of bread
	amount of water added onto the bread
	place to put the bread
	duration of the experiment

The following amount of water was added to both pieces of bread at the start of the experiment.

Bread	Amount of water added at the start of the experiment
A	5 ml
B	25 ml

- (b) Explain why Sheryl observed less mould growing on bread A after some time. [1]



30. John found cell X in a pond, as shown in the diagram below. Cell X has the features of both an animal and plant cell.

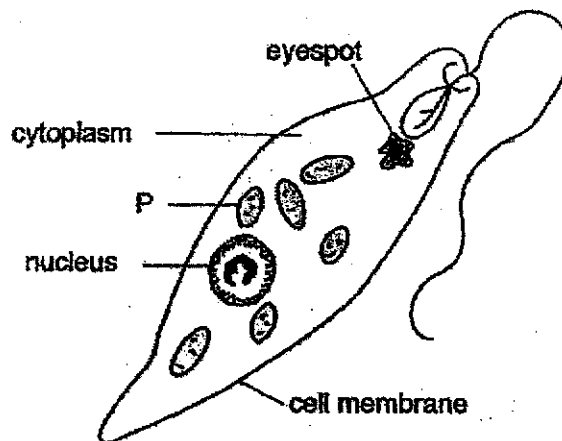

When cell X was viewed under the microscope, it was observed that part P contained a green pigment which could be found in all green parts of a plant.

(a) Based on the diagram above, state the feature of the cell that is similar to an animal cell. [1]

(b) Name part P. [1]

(c) The eyespot of cell X could guide the cell to move towards a light source. Explain how this ability enables cell X to survive. [1]



31. Raj observed part of a leaf under a microscope.

The air space in the leaf may contain gases such as oxygen and carbon dioxide.

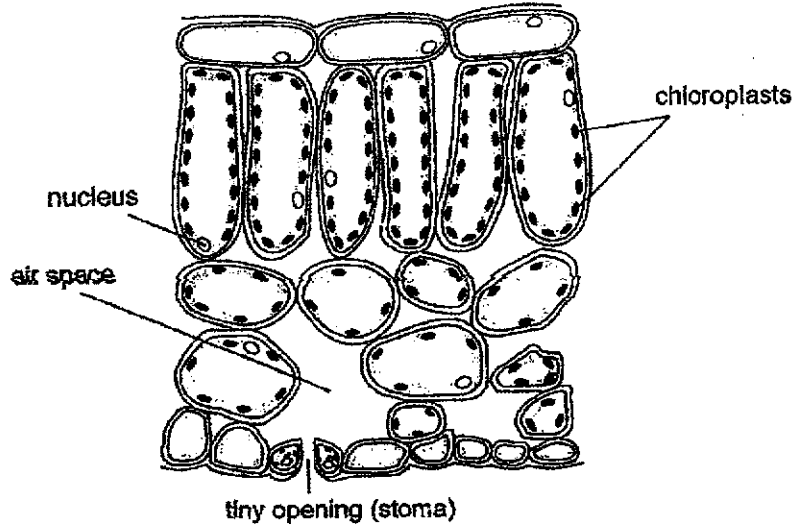

(a) State the function of the tiny opening shown in the diagram above.

[1]

Raj wanted to investigate the rate of photosynthesis taking place in two similar plants, M and N, growing in different locations. He used leaf discs that have been cut from fresh leaves as shown in diagram 1 below.

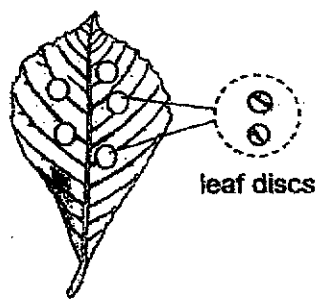

Diagram 1

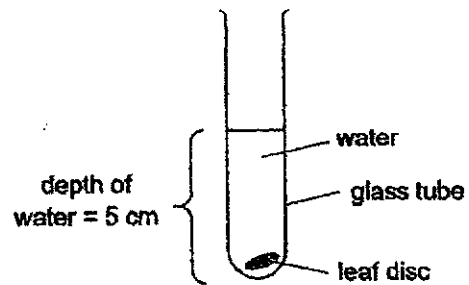

Diagram 2

Raj removed the air from the air space in each leaf disc and placed each leaf disc in a glass tube filled with water to a depth of 5 cm as shown in diagram 2.



Question 31 continued

Raj set-up the experiment as shown below. He used one set-up for each type of plant, M and N.

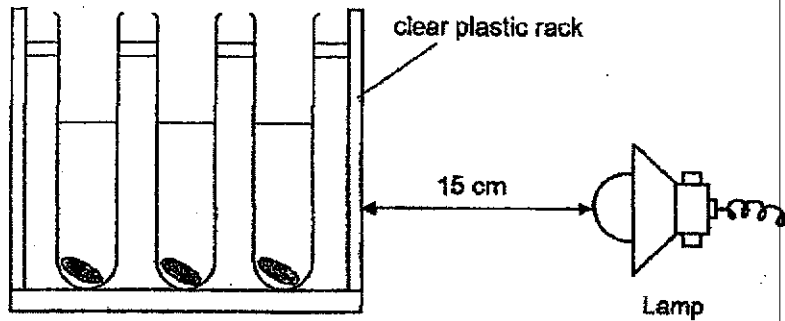

Raj turned on the lamp in each set-up and measured the time taken for each leaf disc to rise. He repeated the experiment 3 times and recorded the results in the table shown below.

Plant	Average time taken (s)			
	Trial 1	Trial 2	Trial 3	Trial 4
M	71	73	74	70
N	164	165	166	168

(b) Explain why the leaf discs rise when the lamp is turned on.

[2]

(c) What can Raj conclude from the experiment? Give a reason for your answer.



32. The diagram shows a displacement can which is useful in measuring the volume of an object.

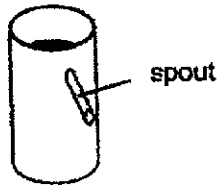

Dinesh wanted to measure the volume of a stone, so he used the following apparatus:

- water
- stone
- container
- displacement can
- measuring cylinder

As the stone does not fit into the measuring cylinder, Dinesh placed the whole stone into the water in the displacement can as shown below.

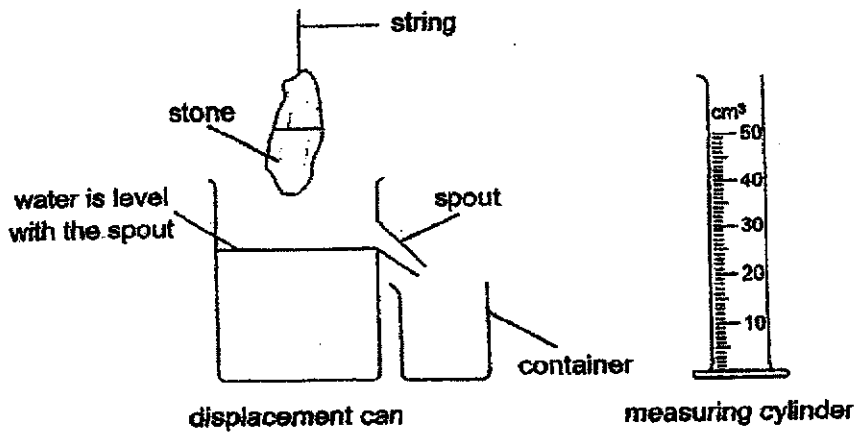

- (a) Describe what Dinesh would observe when he puts the stone into the water. Give a reason for this observation. [1]

- (b) Using the measuring cylinder, describe what Dinesh should do next to find out the volume of the stone. [1]



Question 32 continued

Hema repeated the experiment using a similar set-up as shown below to find the volume of the same stone.

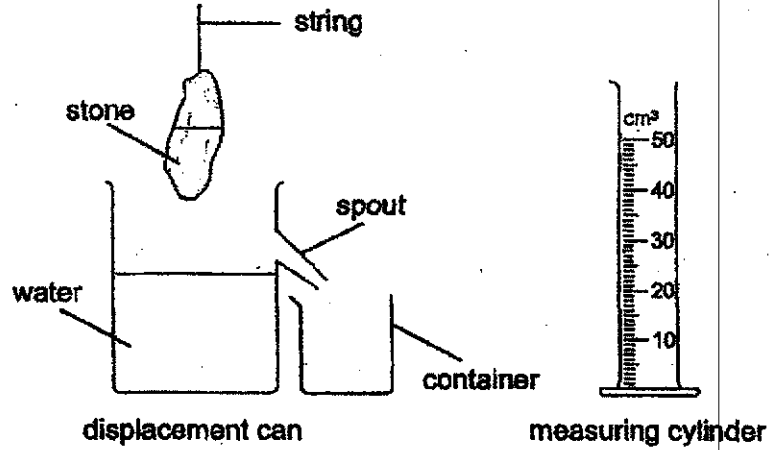

The table shows the results of the experiments carried out by Dinesh and Hema.

Volume of the stone (cm ³)	
Dinesh's result	Hema's result
19	11

(c) Using the information given, explain the difference in the results.

[2]



33. Fish breathe by opening their mouths to allow water containing oxygen to enter as shown in the diagram.

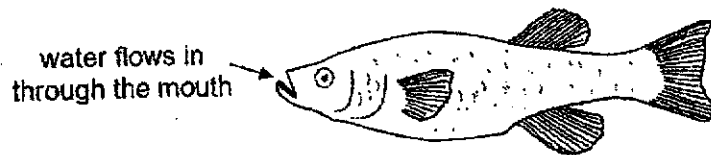

- (a) Name the organ that helps the fish to take in oxygen in the water. [1]

Rani investigated the effect of temperature on the amount of oxygen in water. Rani's hypothesis is as follows:

Cold water contains less oxygen than warm water.

She put similar fish of the same size in tanks of water at different temperatures.

She measured the breathing rate by counting the number of times the fish opened and closed their mouths in a minute.

The results are shown in the table below.

Temperature of water (°C)	Breathing rate (unit)		
	Trial 1	Trial 2	Trial 3
2	4	6	5
8	27	30	29
14	51	49	50
20	76	77	76
26	95	96	94

- (b) Explain why the results do not support Rani's hypothesis. [1]

- (c) Rani kept the size of the fish the same throughout her experiment. Explain how using fish of different sizes would affect the result. [1]



34. The diagram shows fruit Y. Fruit Y is fleshy and juicy.

The seeds are dispersed when the animals eat both the fruit and the seeds and pass the seeds out in their droppings.

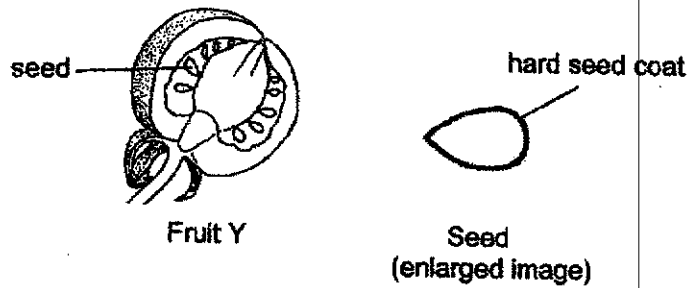

The seeds of fruit Y have hard seed coats as shown above.

(a) Based on the information given, suggest how having hard seed coats is an advantage for the seed's dispersal. [1]

Pei Li conducted an experiment to investigate the conditions needed for germination using the set-ups shown below.

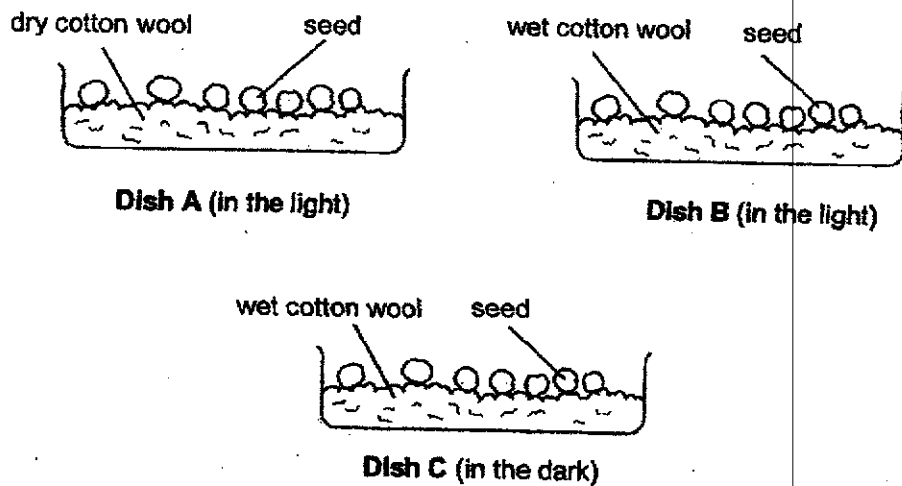

Question 34 continued

After 5 days, the results were shown below.

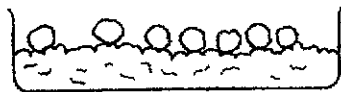

Dish A



Dish B



Dish C

- (b) Based on the diagrams given, state how Pei Li could tell whether the seeds had germinated. [1]

- (c) Based on the results given, explain whether seeds need light and water to germinate. [2]



35. The diagram shows part of a human body system.

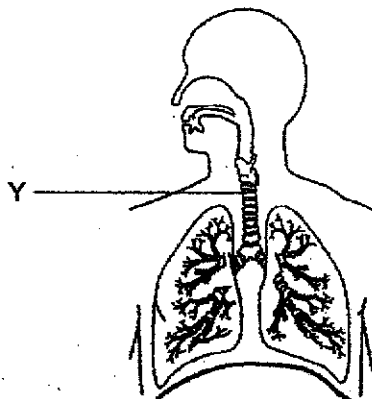

(a) Identify the system and name part Y.

[1]

(i) system - _____

(ii) part Y - _____

Mr Tan is an athlete who uses a machine to track the amount of oxygen his body uses as shown in the diagram below.

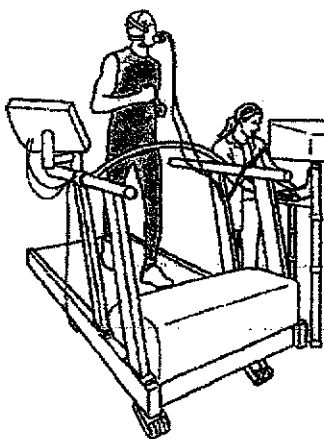

Question 35 continued

The graph shows the amount of oxygen Mr Tan takes in over a period of 20 minutes.

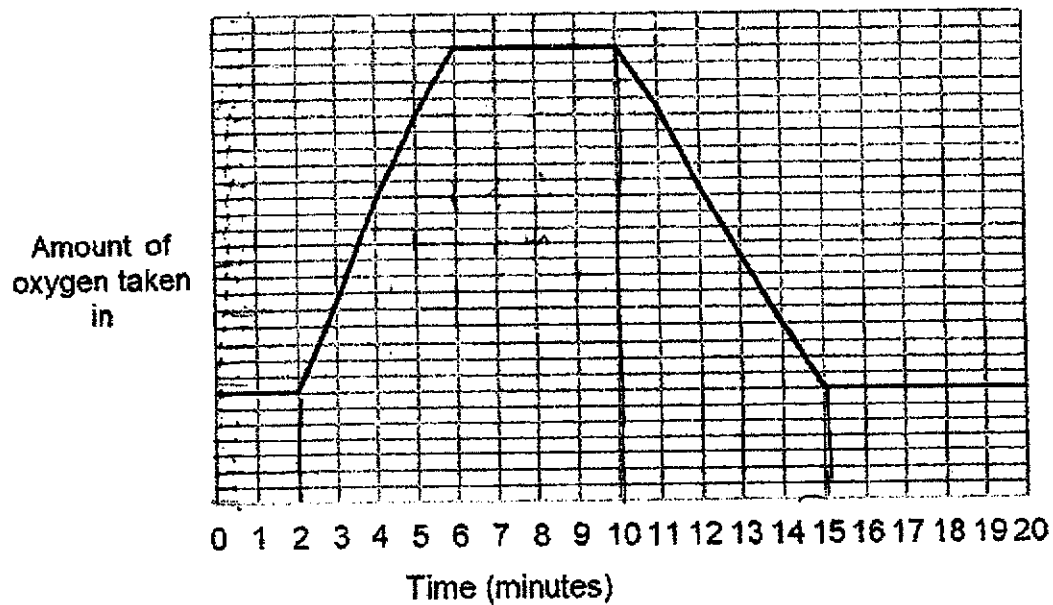

- (b) At which minute does Mr Tan stop exercising? [1]

- (c) What happens to the amount of oxygen taken in by Mr Tan when he is exercising? [2]
Explain your answer.



36. Mani threw a pebble from the edge of a cliff. The path, WYZ, taken by the pebble is shown below.

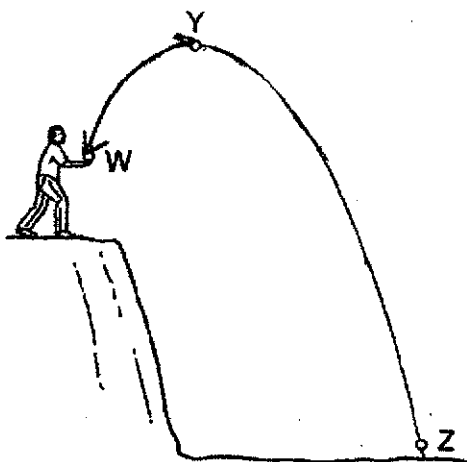

- (a) On the path WYZ in the diagram above, draw 'X' to mark another point that shows that the kinetic energy of the pebble is increasing. [1]

Mani uses a battery-operated motor to pull his boat up from the water as shown below.

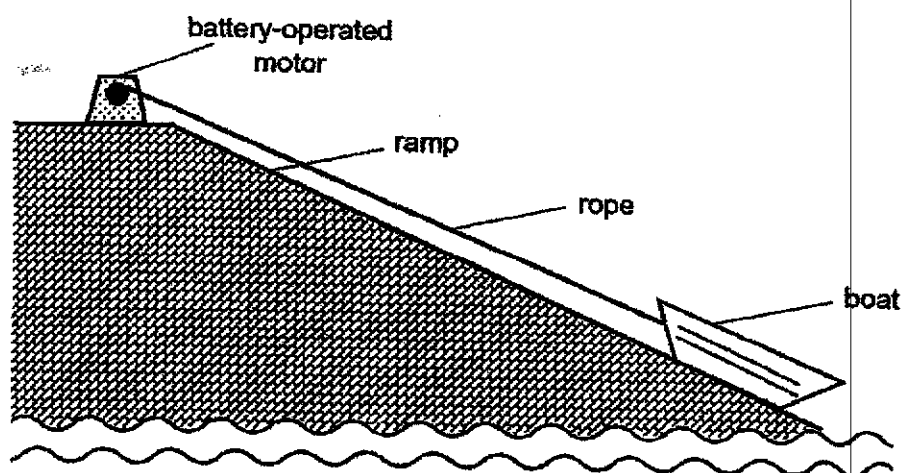

- (b) Name the source of the energy needed to pull the boat up. [1]



Question 36 continued

The diagram shows the energy conversion when the boat is being pulled up.



- (c) Suggest one change that could be made to the surface of the ramp so that less energy is converted to heat when the boat is pulled up. [2]

Explain your answer.



37. David inserted a rod of material W and a thermometer into a styrofoam box as shown. He poured water at 100°C into the styrofoam box and covered the box with a lid.

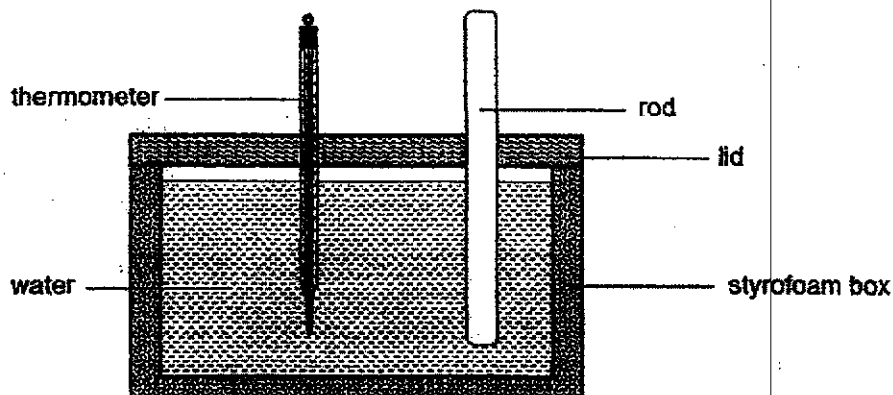

After 15 minutes, the temperature of the water was recorded. David repeated the experiment with similar sized rods of different materials, X, Y and Z.

He recorded his results as shown in the table below.

Material	Temperature of water	
	at the start (°C)	after 15 minutes (°C)
W	100	62
X	100	90
Y	100	70
Z	100	86

- (a) State the aim of the experiment. [1]
-
- (b) Why did the temperature of water decrease after each rod was inserted? [1]
-
- (c) Using the results given, state which material, (W, X, Y or Z), is most suitable for making a container to keep drinks cold for a long period of time. [2]
Explain your answer.
-

38. Jack and Jim dropped iron balls into trays of damp sand as shown below. They measured and recorded the depth of the craters, d , made by the iron balls.

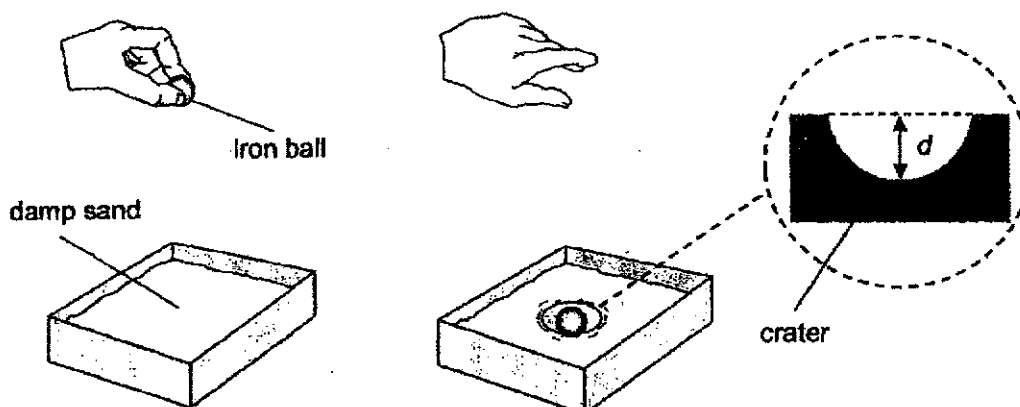

At the end of the experiment, their results are shown in the table below.

Height the iron ball was dropped from (cm)	Depth of crater, d (cm)				
	Jack's results			Jim's results	
	Trial 1	Trial 2	Trial 3	Trial 1	Trial 2
10	1.2	1.3	1.2	1.0	1.2
20	1.4	1.5	1.5	1.4	1.5
30	1.6	1.6	1.7	1.6	1.7
40	1.9	2.0	2.0	2.0	1.8

- (a) Based on the results given, state the relationship between the depth of the crater and the height the iron ball was dropped from. [1]

- (b) Explain, in terms of energy conversion, your answer in (a). [1]



Question 38 continued

- (c) Based on the results given, explain why Jack's experiment is better than Jim's. [1]

Jack decided to use an electromagnet to drop the iron ball as shown below.

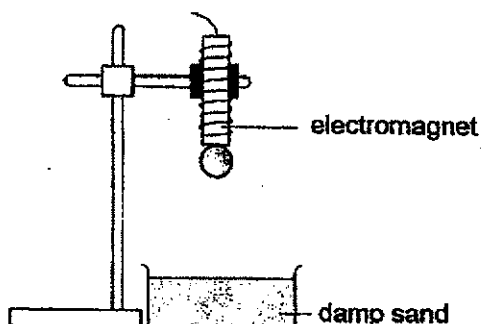

- (d) Suggest two ways the method shown above improves the experiment. [1]

(i) _____

(ii) _____

Study the news article shown below.

NEWS

Throwing litter from high-rise buildings can cause damage to properties as well as serious injuries to people. It is an offence punishable by law.

- (e) People may be injured when they are hit by objects thrown out from high-rise buildings. Explain why. [1]



39. Dani conducted an experiment to study how the arrangement of bulbs in a circuit affected their brightness. He used all of the apparatus for his experiment:

- six identical bulbs
- four identical batteries
- wires

After setting up his experiment, he discovered that when one bulb fused, the remaining bulbs in set-up A did not light up, while the remaining bulbs in set-up B still remain lit.

(a) In the space provided below, draw a diagram (using circuit symbols) for each of the set-ups that he constructed to conduct his experiment. He conducted both experiments at the same time. [2]

Set-up A	Set-up B



Question 39 continued

The diagram below shows an electric hairdryer.

Dani uses the hairdryer to dry his wet hair. Switches can be turned on and off for cold and hot air to be blown out.

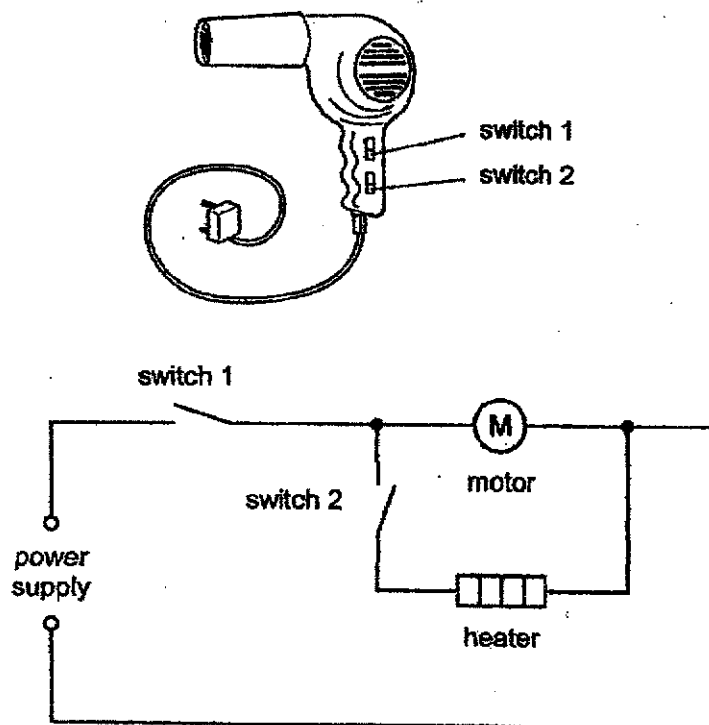

- (b) Using the circuit diagram above, describe how Dani uses switches 1 and 2 to get hot and cold air from the hairdryer. [2]



40. Organism W lives in the desert. The temperature in the desert can range from as low as 10°C at night to as high as 45°C in the day.

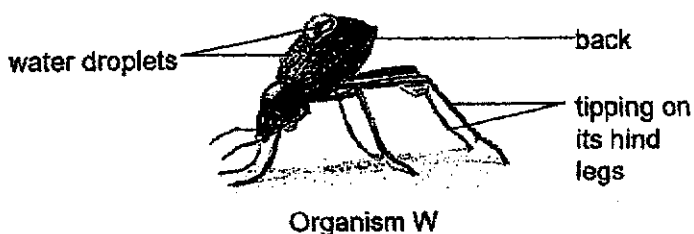

- (a) In the morning, water droplets are found on the back of organism W. How are the water droplets formed? [2]

The diagram shows a bottle which is designed to harvest water from the air. The dome-shaped design resembles the body of organism W.

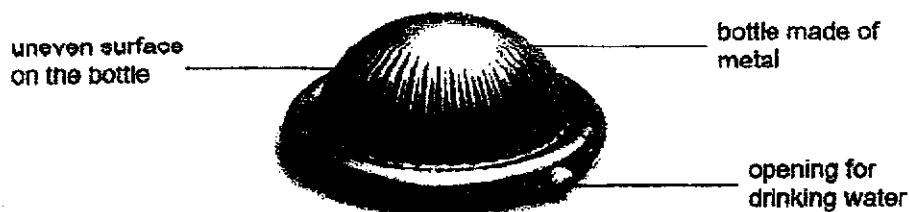

The bottle is placed outside in the evening, allowing the steel body to cool. In the morning, when the surrounding air is warmer, the dew drops are formed and collected in the bottle.

- (b) How does the uneven surface of the bottle help to collect more water? [1]

End of Booklet B



SCHOOL : HENRY PARK PRIMARY SCHOOL
LEVEL : PRIMARY 6
SUBJECT : SCIENCE
TERM : 2021 PRELIM

CONTACT : CALL

SECTION A

Q 1	Q2	Q3	Q4	Q5	Q6	Q7	Q8	Q9	Q10
3	3	4	4	1	4	3	3	1	4
Q 11	Q12	Q13	Q14	Q15	Q16	Q17	Q18	Q19	Q20
2	3	2	4	3	2	4	2	3	1
Q 21	Q22	Q23	Q24	Q25	Q26	Q27	Q28		
2	1	2	3	4	4	2	1		

2021 P6 Prelim Science – Suggested Answers

Qn No.	Suggested Answers										
29(a)	<table border="1"> <thead> <tr> <th data-bbox="347 353 451 398">Tick (✓)</th> <th data-bbox="451 353 834 398">Variable</th> </tr> </thead> <tbody> <tr> <td data-bbox="347 398 451 443">✓</td> <td data-bbox="451 398 834 443">Size of bread</td> </tr> <tr> <td data-bbox="347 443 451 499"></td> <td data-bbox="451 443 834 499">Amount of water added onto the bread</td> </tr> <tr> <td data-bbox="347 499 451 544">✓</td> <td data-bbox="451 499 834 544">Place to put the bread</td> </tr> <tr> <td data-bbox="347 544 451 600">✓</td> <td data-bbox="451 544 834 600">Duration of the experiment</td> </tr> </tbody> </table>	Tick (✓)	Variable	✓	Size of bread		Amount of water added onto the bread	✓	Place to put the bread	✓	Duration of the experiment
Tick (✓)	Variable										
✓	Size of bread										
	Amount of water added onto the bread										
✓	Place to put the bread										
✓	Duration of the experiment										
29(b)	Bread A had less water / moisture OR Bread B had more water / moisture.										
30(a)	Cell X does not have a cell wall.										
30(b)	Chloroplast(s)										
30(c)	It allows the <u>chlorophyll to trap light and make food.</u>										
31(a)	The tiny opening allows exchange of gases between the plant and the surrounding.										
31(b)	The leaf disc carries out photosynthesis in the presence of light and produces oxygen which fills up the air spaces OR is released as bubble(s) that bring(s) the leaf disc to the water surface as it floats up.										
31(c)	Plant M carries out photosynthesis faster as the time taken for its leaf discs to rise is shorter.										
32(a)	Some <u>water will flow into the container</u> as the <u>stone displaces the water / as the stone takes up space</u> in the can.										
32(b)	<u>Pour the water</u> collected in the container <u>into the measuring cylinder</u> and <u>measure its volume.</u>										
32(c)	In Hema's set-up, <u>water level is below the spout</u> so <u>the volume of water collected</u> in the container <u>will be smaller / lesser</u> than the <u>volume of the stone.</u>										
33(a)	Gill(s)										
33(b)	The <u>breathing rate is lower in cold water</u> and so, the <u>cold water contains more oxygen.</u>										
33(c)	<u>Fish of different sizes may need / use different amounts of oxygen</u> so their <u>breathing rates might be different.</u>										
34(a)	The <u>seeds will not be digested</u> when the animals feed on the fruits.										
34(b)	The appearance of the roots.										
34(c)	Seeds <u>kept in the dark germinated</u> so seeds <u>do not need light.</u> Seeds <u>kept in dry cotton did not germinate</u> so seeds <u>need water.</u>										

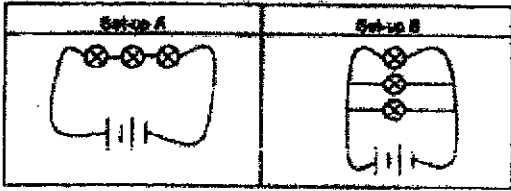
35(a)	(I) system – respiratory (II) part Y – windpipe	
35(b)	10 th minute	
35(c)	His oxygen consumption increases which is needed to produce more energy.	
36(a)	'X' should be marked on the line between point Y and point Z (inclusive).	
36(b)	Battery	
36(c)	Apply a lubricant to reduce the friction between the ramp and the boat. Less heat is produced when friction is reduced.	
37(a)	To find out which material is the best / poorest conductor of heat.	
37(b)	The hot water lost heat to the rod.	
37(c)	Material X. The temperature of water with rod of material X decreased the slowest in 15 minutes. Hence, this shows that X is the poorest heat conductor and will conduct heat from the surroundings to the cold drinks the slowest.	
38(a)	As the <u>height the iron ball was dropped from increases</u> , the <u>depth of the crater increases</u> .	
38(b)	The ball has <u>more (gravitational) potential energy</u> which <u>converts to more kinetic energy</u> , so it <u>goes deeper into the sand</u> .	
38(c)	Jack's <u>results are more reliable</u> as he conducted the experiment <u>more times</u> .	
38(d)	<ul style="list-style-type: none"> • The amount of force used to release the iron ball is kept the same. • The dropping height of the iron ball is kept the same. 	
38(e)	The object has <u>more potential energy</u> that converts to (more) kinetic energy, <u>hitting a person with more force / impact</u> .	
39(a)		
39(b)	When Dani <u>presses on switch 1</u> , only <u>one circuit with the motor is closed</u> and the motor will <u>turn on to produce cold air</u> . When <u>both switches are pressed</u> , <u>both circuits are closed</u> and the <u>motor and heater will turn on to produce hot air</u> .	
40(a)	The <u>water vapour in the surrounding air loses heat</u> and <u>condenses on the cool(er) surface of the back of organism Z</u> to form water droplets.	
40(b)	The <u>uneven surface of the ridges increases the surface area</u> so that <u>more water vapour can condense on it / it increases rate of condensation</u> .	

