

SA2

**2021 PRIMARY 6 PRELIMINARY EXAMINATION**

Name: _____ ()

Date: 20 August 2021

Class: Primary 6 ()

Time: 8.00 a.m. - 9.45 a.m.Duration: 1 hour 45 minutes

Parent's Signature: _____

Marks: _____ / 56

**SCIENCE
BOOKLET A****INSTRUCTIONS TO CANDIDATES**

- (1) Write your name, class and register number.
- (2) Do not turn over this page until you are told to do so.
- (3) Follow all instructions carefully.
- (4) Answer all questions.
- (5) Shade your answers on the Optical Answer Sheet (OAS) provided.

Booklet A (28 x 2 marks)

For each question from 1 to 28, four options are given. One of them is the correct answer. Make your choice (1, 2, 3 or 4) and shade your answer on the Optical Answer Sheet.

(56 marks)

1. Study the classification chart and the three animals, X, Y and Z.

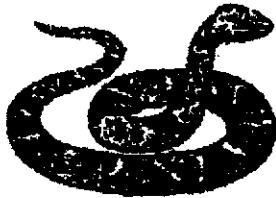

X

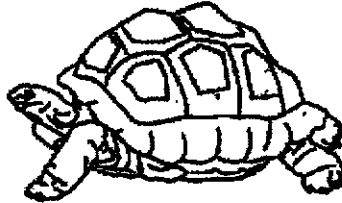

Y



Z

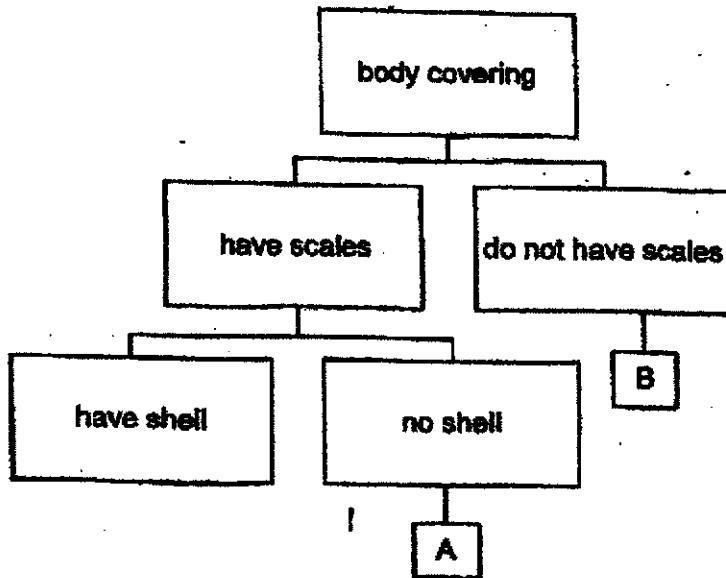

Which of the following shows the correct classification of animals in boxes A and B?

	A	B
(1)	Z	Y
(2)	X	Y
(3)	Y	Z
(4)	X	Z

2. The diagram below shows insect F.



Which of the following correctly represents insect F's life cycle?

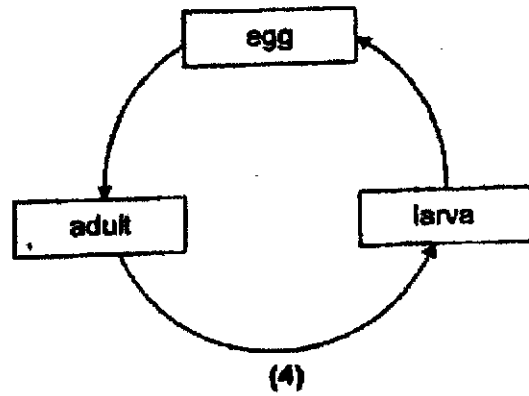
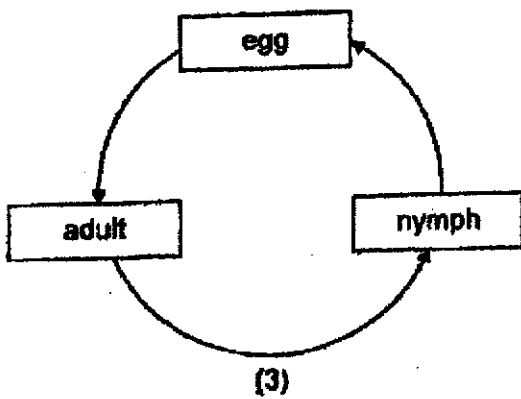
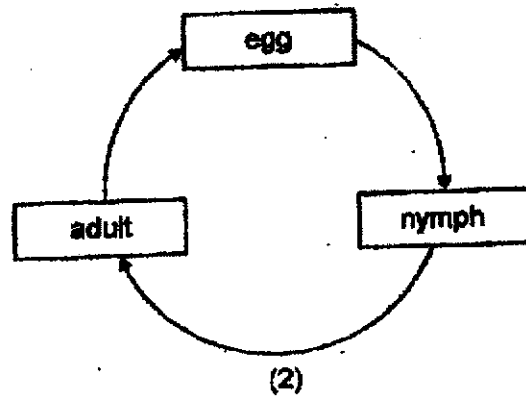
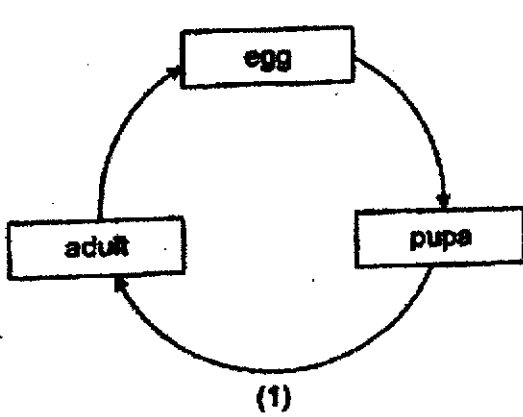

3. The diagrams below show a flower, human female reproductive system and human male reproductive system.

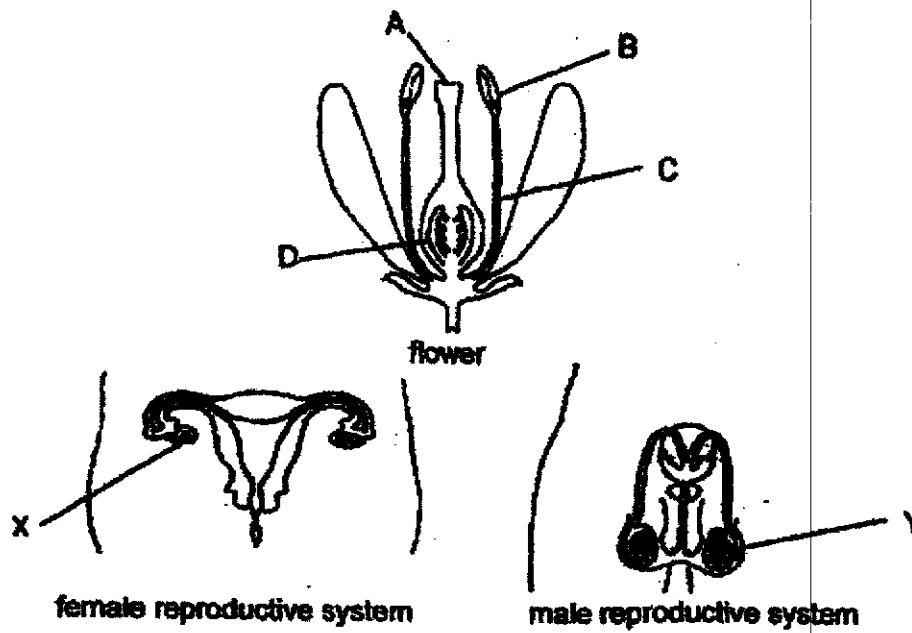

Which parts of the above flower have the same functions as X and Y in humans?

	X	Y
(1)	C	A
(2)	A	B
(8)	D	C
(4)	D	B

4. Study the characteristic of fruit Z below.

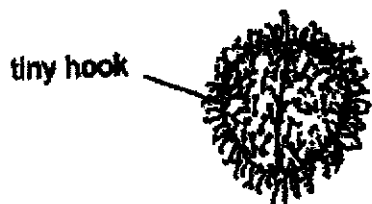

Key	
△	parent plant of Z
●	seedling of Z
→	wind direction

Which of the following maps below correctly shows where the seedlings of fruit Z are growing?

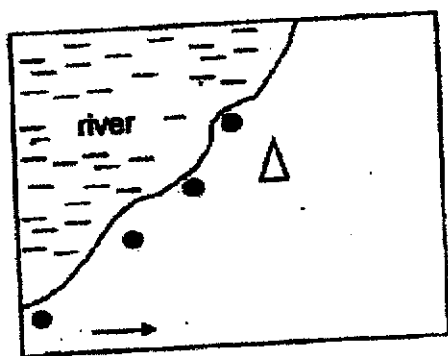

(1)

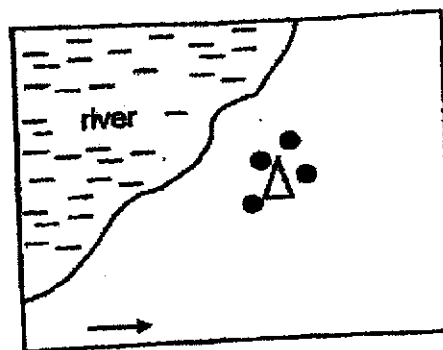

(2)

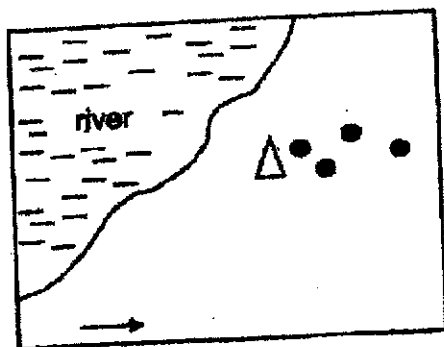

(3)

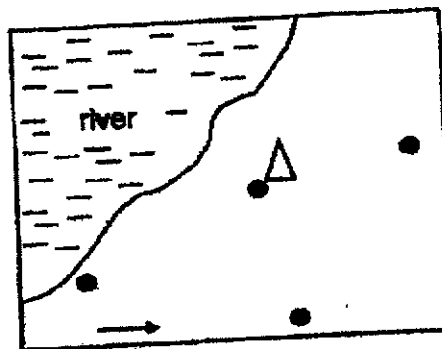

(4)

5. Study the diagram of a plant below.

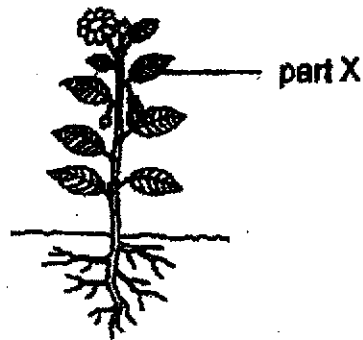

What is / are the function(s) of part X?

- A. To make food for the plant
 B. To take in water for the plant
 C. To allow gaseous exchange between the plant and the surroundings
- (1) A only
 (2) B only
 (3) A and C only
 (4) B and C only
6. Animal X is kept in an airtight glass jar for two hours as shown in the diagram below.



Which of the following correctly shows the changes in the temperature of air and amount of water vapour in the glass jar after two hours?

	temperature of air	amount of water vapour
(1)	increases	decreases
(2)	increases	increases
(3)	decreases	remains the same
(4)	remains the same	increases

7. The diagram below shows a human body system. Arrows, A, B, C, D, E and F, represent the movement of blood in parts of the system.

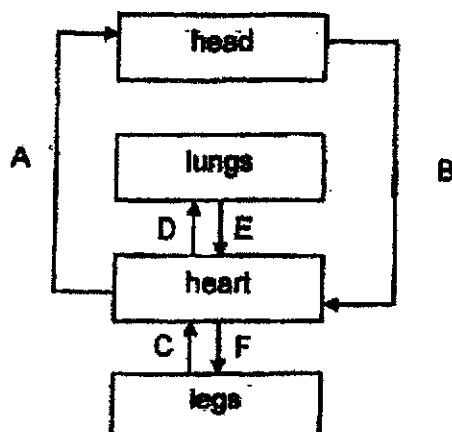

In the diagram above, which arrows represent blood rich in oxygen?

- (1) A and B only
 - (2) D and E only
 - (3) A, E and F only
 - (4) B, C and D only
8. Xiaoming set up an experiment as shown below to find out how the exposed surface area of food affects the rate of digestion.

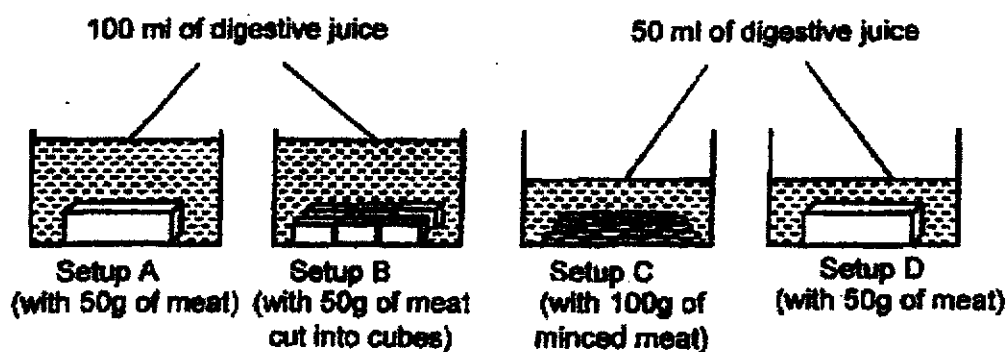

Which two set-ups should he use to carry out a fair test?

- (1) A and B
- (2) A and D
- (3) B and C
- (4) B and D

9. An animal cell was placed in a liquid containing substances X and Y.

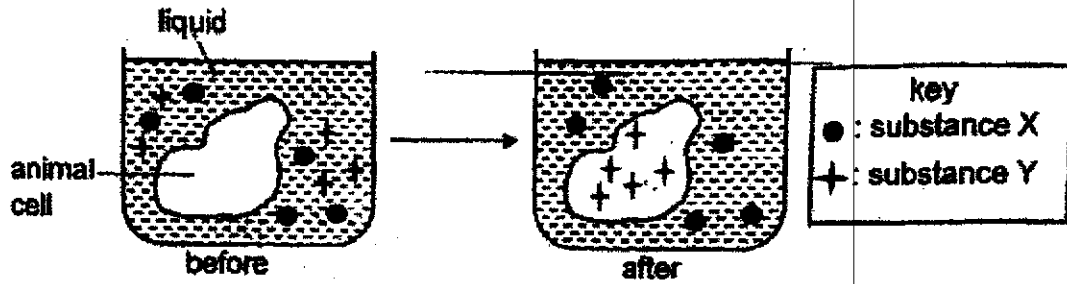

Which of the following statements can be concluded from his observation?

- (1) The nucleus allows only Y to enter the cell.
 - (2) The cell wall does not allow X to enter the cell
 - (3) The cytoplasm does not allow X to enter the cell.
 - (4) The cell membrane allows only Y to enter the cell.
10. The diagram below shows the different stages of germination in a seed.

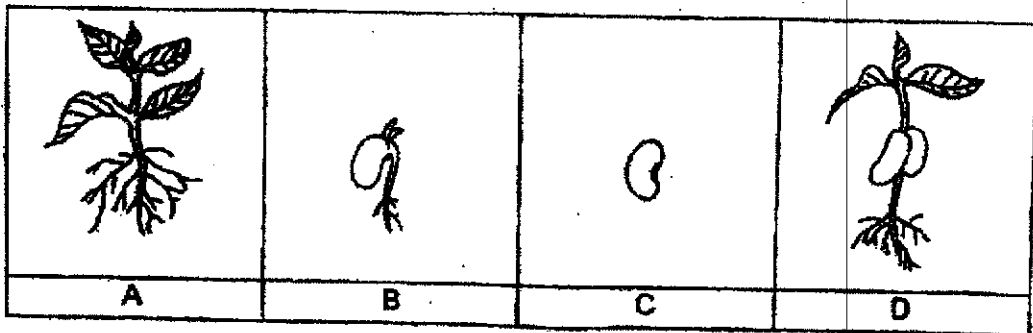

At which stage(s), A, B, C or/ and D, would the plant be able to make its own food?

- (1) A only
- (2) A and D only
- (3) B and C only
- (4) B and D only

11. Study the flow chart below.

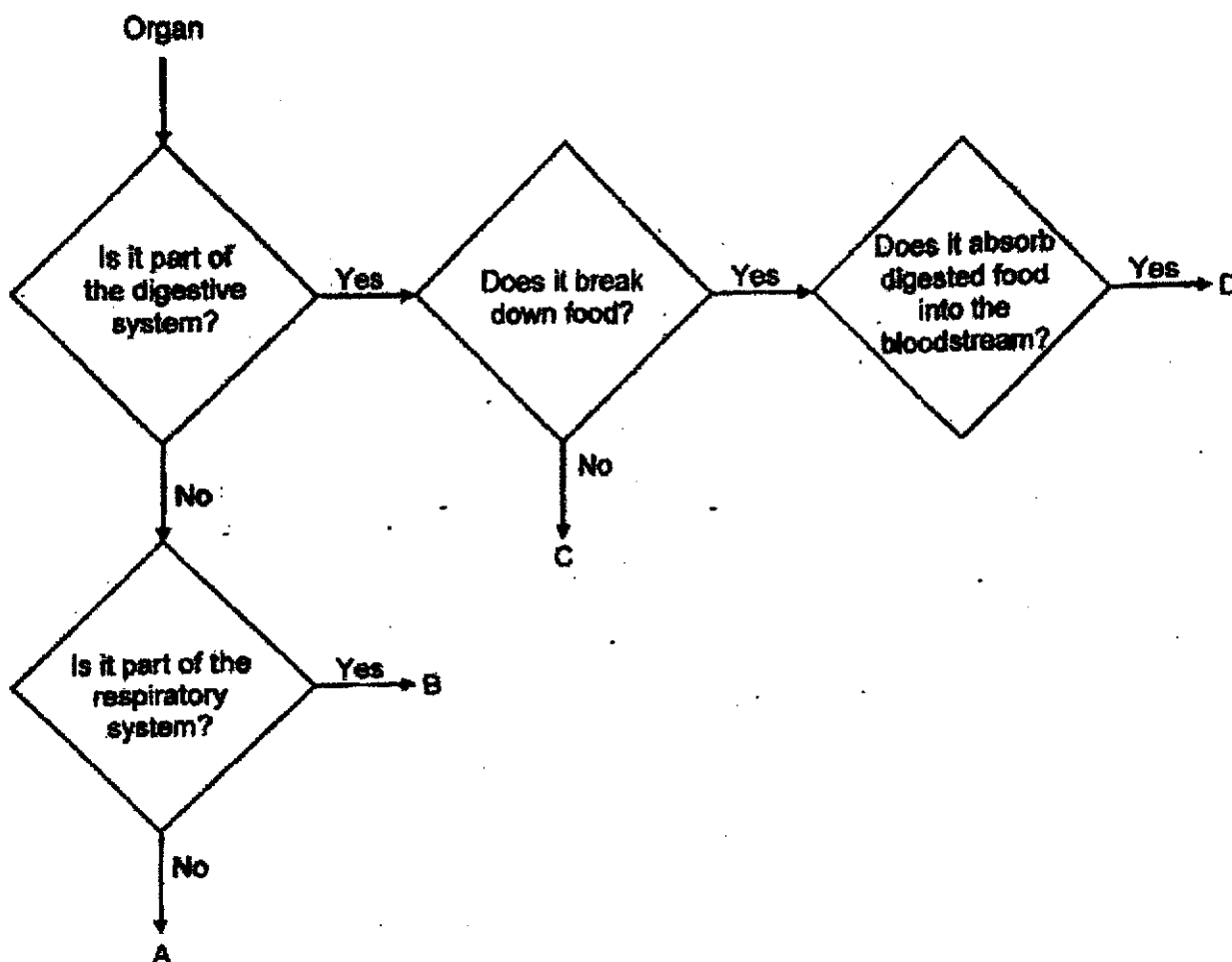

Which of the following letters are correctly matched to the different body parts?

	lungs	heart	small intestine	large intestine
(1)	A	B	C	D
(2)	A	B	D	C
(3)	B	A	C	D
(4)	B	A	D	C

12. Beakers, A, B, C and D, are filled with equal amounts of water and placed under the sun as shown below.

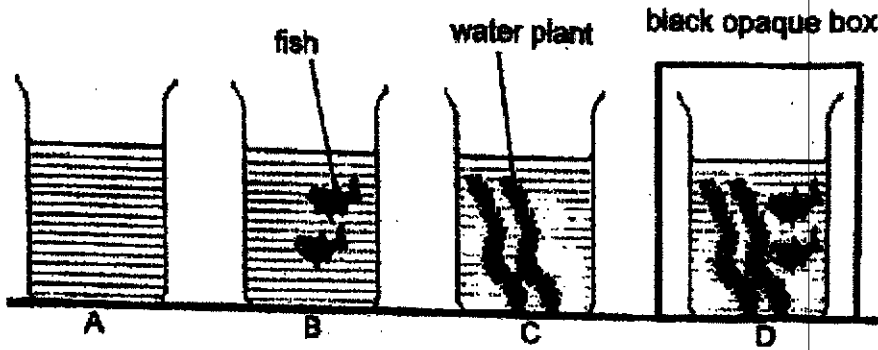

Which of the following shows the correct amount of carbon dioxide in each beaker after six hours?

amount of carbon dioxide

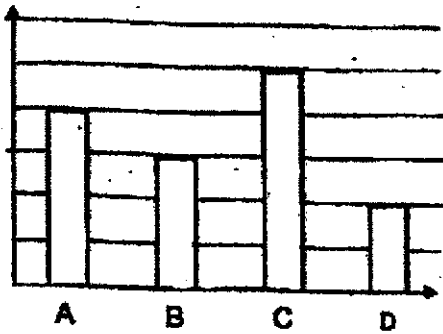

(1)

amount of carbon dioxide

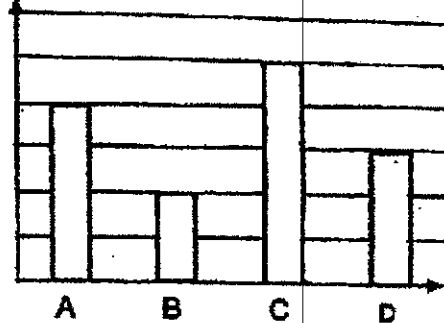

(2)

amount of carbon dioxide

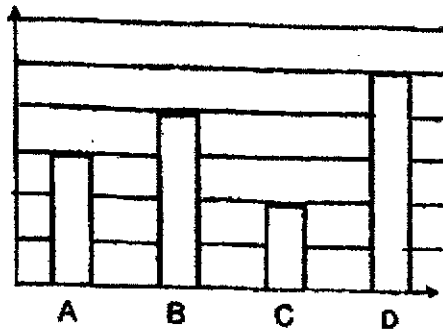

(3)

amount of carbon dioxide

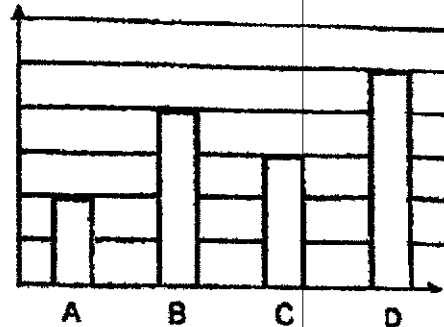

(4)

13. Mrs Chu prepared four pots of strawberries and put each pot in different conditions as shown in the table below.

Conditions	set-up A	set-up B	set-up C	set-up D
Type of soil	garden	garden	garden	sandy
Amount of soil (g)	1000	500	1000	500
Amount of light (unit)	5000	5000	18000	18000
Taste of strawberries	sweet	sweet	very sweet	sour

From the results, Mrs Chu concluded that the strawberries would be sweeter when the rate of photosynthesis is higher.

Which of the following set-ups did she use to make her conclusion?

- (1) A and B
 - (2) A and C
 - (3) B and C
 - (4) C and D
14. The mimosa plant will fold its leaves when raindrops touch the leaves as shown below.

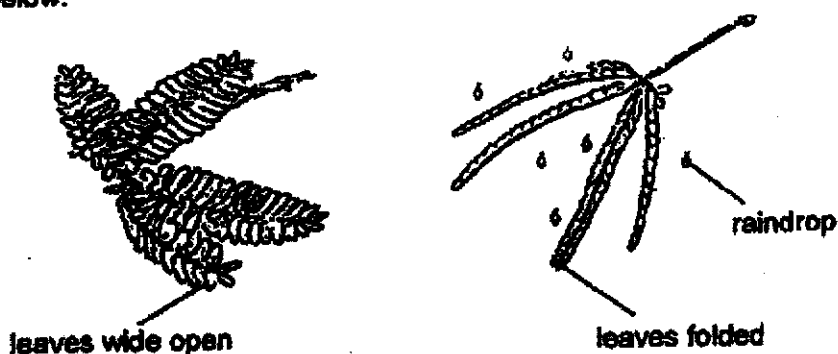

What conclusion can be made from the above observation?

- (1) Living things can die.
- (2) Living things can reproduce.
- (3) Living things need air, food and water to stay alive.
- (4) Living things can respond to changes around them.

15. The diagram shows a cord made of material C attached to a bungee jumper.

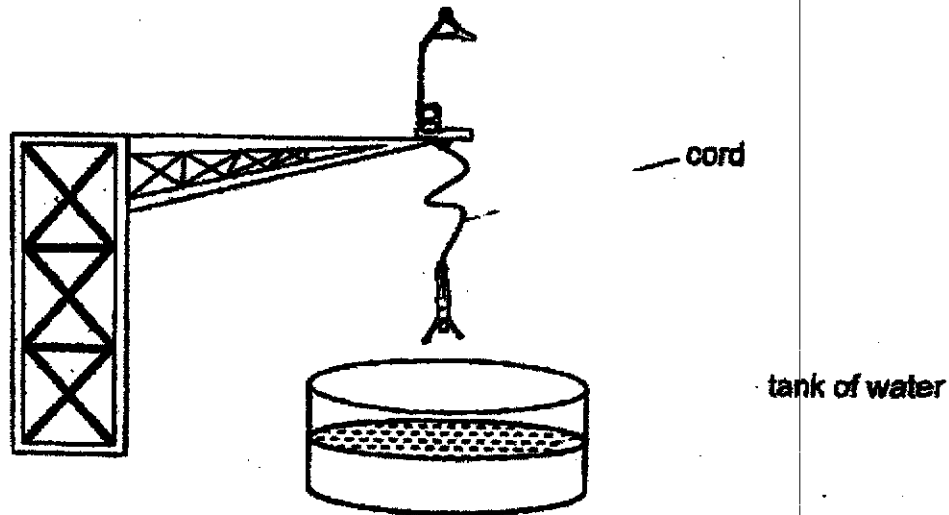

Which property of the material C enables the bungee jumper to bounce up and down?

- (1) elastic
 - (2) strong
 - (3) absorbent
 - (4) waterproof
16. Muthu prepared two set-ups with the same amount of water but of different temperatures. He placed them in a room at 25°C as shown below.

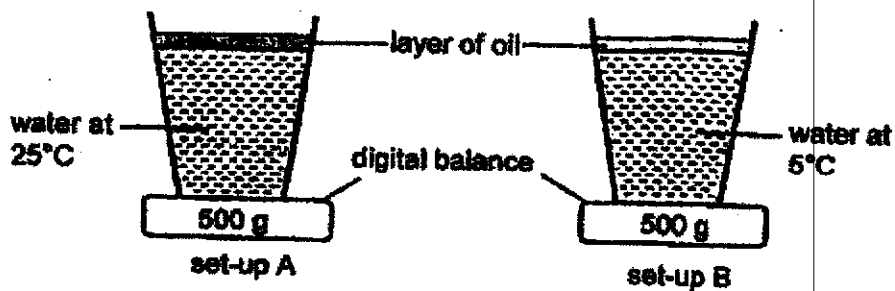

Which of the following shows the possible changes in the mass shown on the digital balance after 15 minutes?

	set-up A	set-up B
(1)	remains the same	remains the same
(2)	remains the same	increases
(3)	increases	remain the same
(4)	decreases	increases

17. Identical batteries and bulbs are used to set up the four circuits below.

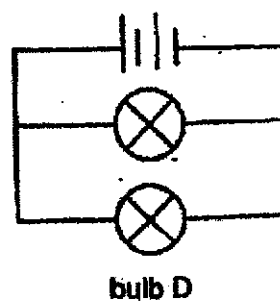
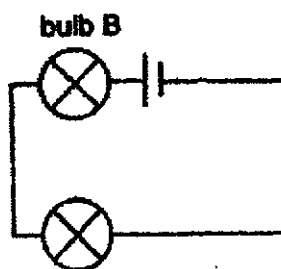
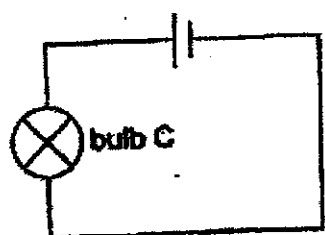
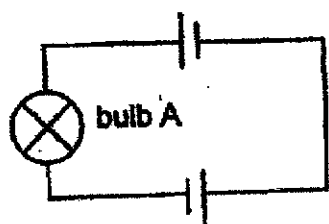

Which of the two bulbs have equal brightness?

- (1) A and B
- (2) A and D
- (3) B and D
- (4) C and D

18. Kumar connected objects, X, Y and Z, to the circuit below. He observed that Bulb A remain unlit while Bulb B lit up when the switch was closed.

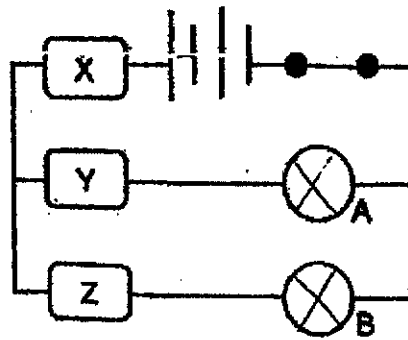

Based on Kumar's observation, in which of the following circuits will all the bulb(s) light up?

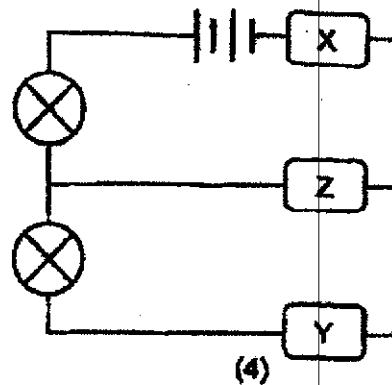
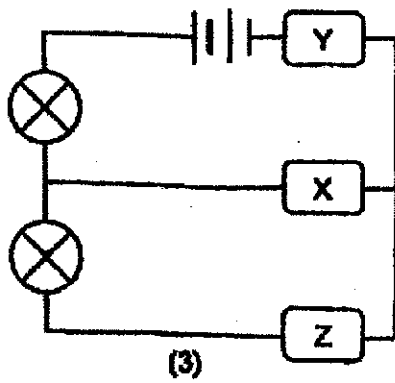
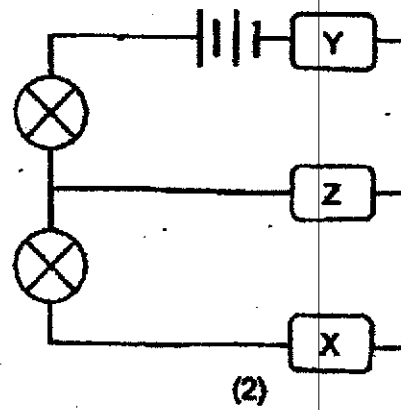
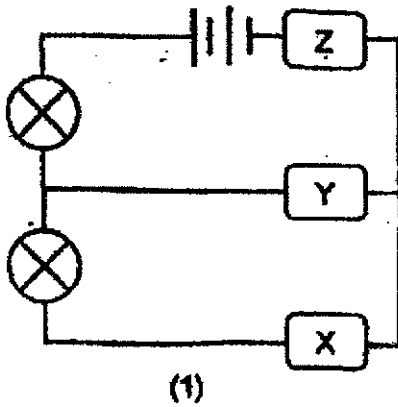

19. A torch and three objects, A, B and C, were arranged in a straight line in front of a screen as shown in the diagram below.

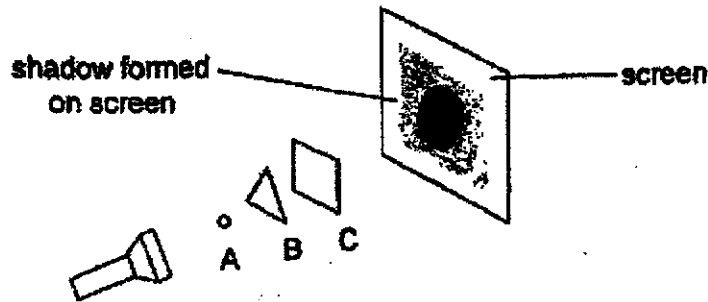

Which properties should objects, A, B and C, have in order to form the shadow shown on the screen?

	allows most light to pass through	allows some light to pass through	does not allow light to pass through
(1)	A	C	B
(2)	C	B	A
(3)	B	A	C
(4)	B	C	A

20. Study the set-up shown below. The room temperature is 30°C.

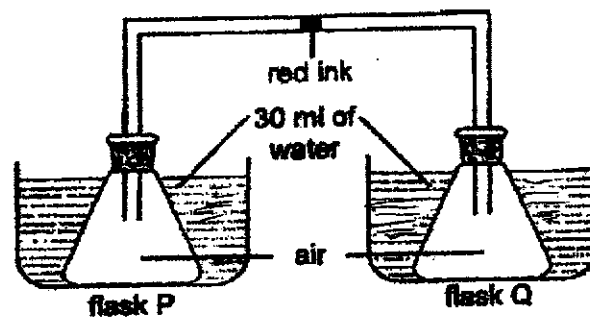

Which of the following conditions would cause the drop of red ink to move the slowest towards flask Q?

	temperature of water flask P is placed in	temperature of water flask Q is placed in
(1)	room temperature	room temperature
(2)	5°C	70°C
(3)	70°C	5°C
(4)	70°C	room temperature

21. Ben has a bicycle. Its lamp is connected to a device that can generate electricity only when the wheel turns. Thus, when Ben paddles, the lamp lights up.

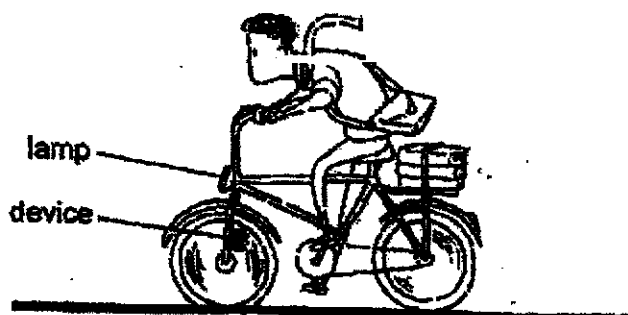

Which of the following shows the correct energy conversion as Ben cycles his bicycle to light its lamp?

- (1) electrical energy \rightarrow kinetic energy \rightarrow light energy
(device) (legs) (lamp)
- (2) kinetic energy \rightarrow kinetic energy \rightarrow light energy
(legs) (wheel) (lamp)
- (3) kinetic energy \rightarrow kinetic energy \rightarrow electrical energy \rightarrow light energy
(legs) (wheel) (device) (lamp)
- (4) potential energy \rightarrow kinetic energy \rightarrow potential energy \rightarrow light energy
(legs) (legs) (device) (lamp)
22. A girl on a swing was released from position A. She then moved to position B, and then to position C.

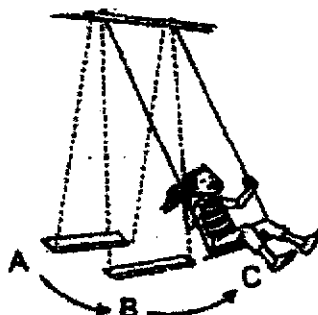

Which of the following is correct?

	Kinetic energy from A to B	Potential energy from B to C
(1)	increased	increased
(2)	increased	decreased
(3)	decreased	increased
(4)	decreased	decreased

23. Muthu has three metal bars, A, B and C. The arrows below show how the metal bars moved when they were brought near each other.

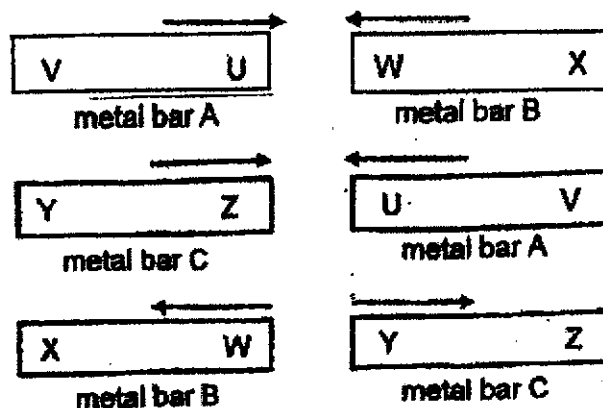

Based on his observations above, what could metal bars A, B and C be?

	metal bar A	metal bar B	metal bar C
(1)	magnet	magnet	magnet
(2)	magnet	magnetic object	magnetic object
(3)	magnetic object	magnet	magnet
(4)	magnetic object	non-magnetic object	non-magnetic object

24. The diagram shows three substances, P, Q and R, in three identical containers.

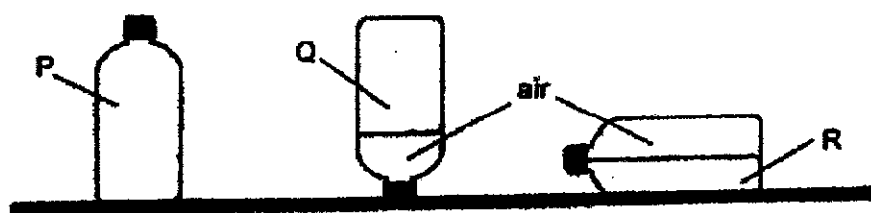

Based on the diagram above, which of the following is definitely correct?

- (1) Q is a solid and has a fixed volume.
- (2) P is a gas and has the largest volume
- (3) P and R are solids and have fixed volumes
- (4) R is a liquid and takes the shape of the container.

25. A strong magnet is fixed to the base of a ramp. A wooden block with an attached spring is then released along the ramp.

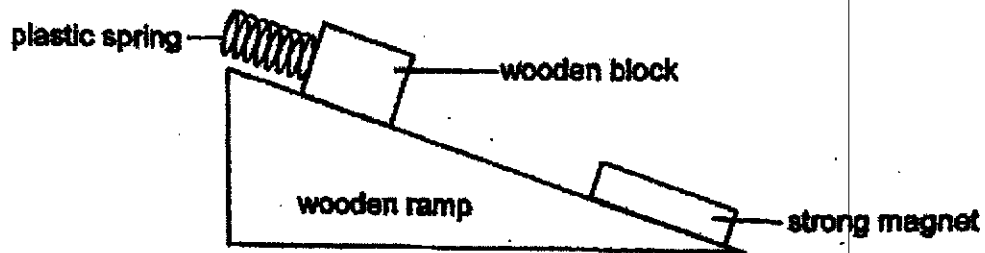

Which of the force acted on the block as it moved down the ramp?

- A frictional force
- B magnetic force
- C gravitational force
- D elastic spring force

- (1) A and C only
- (2) B and D only
- (3) A, B and C only
- (4) A, B, C and D

26. Benny wanted to find out how much force is needed to move three identical wooden blocks over the glass surfaces, from Point A to B. He pulled a spring balance in the direction of the arrow as shown below.

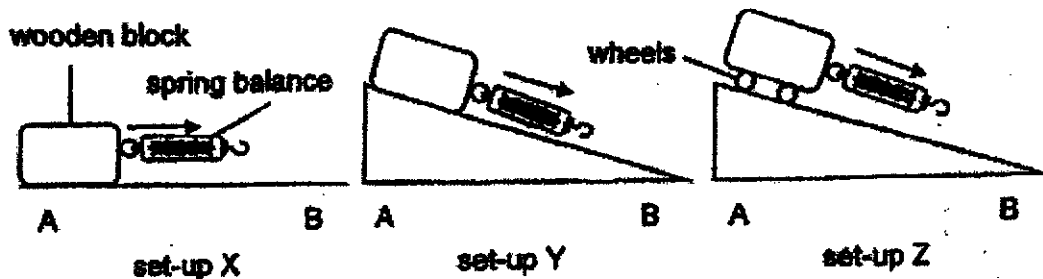

Which of the following most likely represent the amount of force needed to move the wooden blocks in set-ups, X, Y and Z?

	least amount of force needed → most amount of force needed		
(1)	Z	Y	X
(2)	X	Y	Z
(3)	X	Z	Y
(4)	Y	X	Z

27. Bala placed two solid balls, E and F, on a balancing scale in set-up X. He then put each ball into two identical beakers, containing the same amount of water in set-up Y. He observed that the balance tilted at one end and the water level in both beakers rose to the same height as shown below.

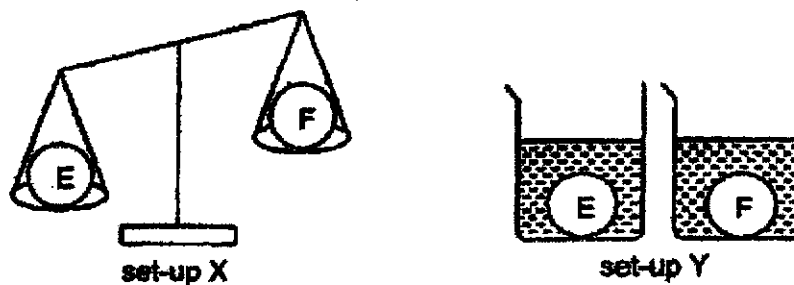

What conclusion can be made from the observations?

- (1) E and F are made of the same material
- (2) E has a bigger mass and bigger volume than F.
- (3) E and F has different volumes and different masses.
- (4) E and F have the same volumes but different masses.

28. The diagram below shows the path of a ball after it was thrown into the air.

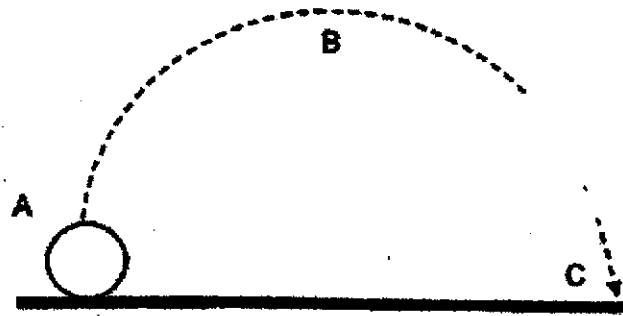

Which of the following graphs shows the amount of gravitational force acting on the ball at points A, B and C?

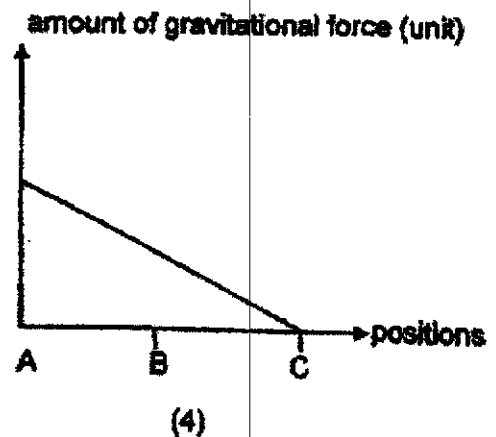
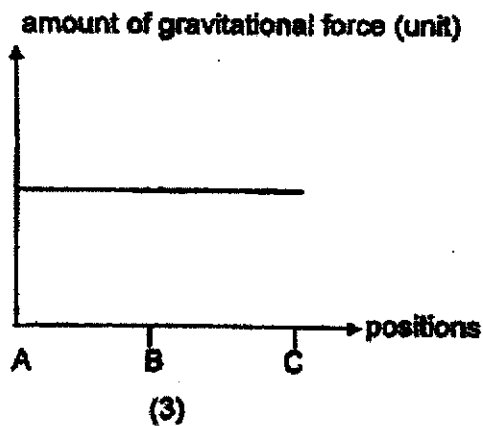
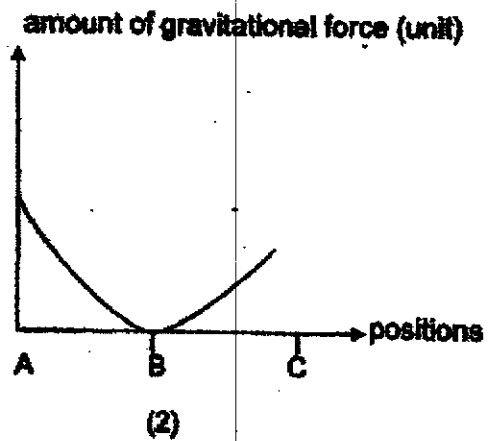
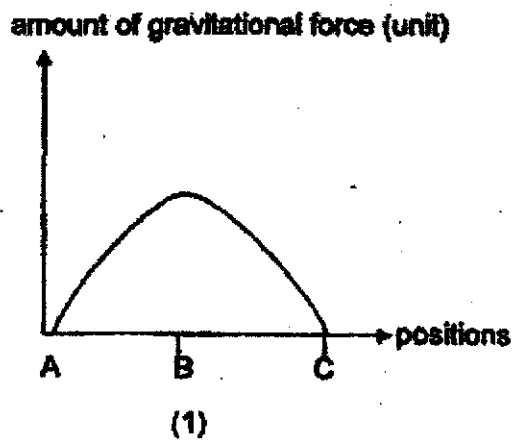

End of Booklet A



2021 PRIMARY 6 PRELIMINARY EXAMINATION

Name : _____ ()

Date: 20 August 2021

Class : Primary 6

Time: 8.00 a.m. – 9.45 a.m.

Parent's Signature : _____

Duration: 1 hour 45 minutes

SCIENCE

BOOKLET B

INSTRUCTIONS TO CANDIDATES

1. Write your name, class and register number.
2. Do not turn over this page until you are told to do so.
3. Follow all instructions carefully.
4. Answer all questions.
5. Write your answers in the booklet.

Booklet A	56
Booklet B	44
Total	100

Booklet B (44 marks)

For questions 29 to 41, write your answers clearly in this booklet.
The number of marks available is shown in brackets [] at the end of each question or part question. (44 marks)

29. Yunus carried out an experiment by putting two similar muffins, A and B, in separate, identical bags at room temperature. The diagram below shows the condition of the muffins after a week.

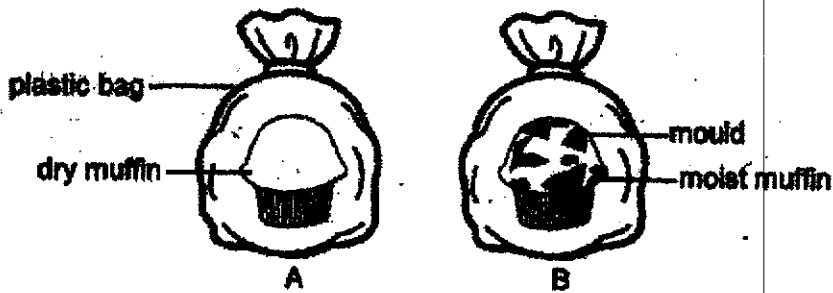

- a) Based on the results above, what is the purpose of the experiment? [1]

- b) State the process that has taken place in this experiment. [1]

- c) What would be the likely result of Yunus' experiment if both muffins had been placed in a freezer for a week? Explain why. [1]

2

Score	3
-------	---

30. Rui Yee had three similar-sized containers made of different materials, C, D and E. She filled the containers with equal amounts of water and left them in a room for five days. The diagram below shows the amount of water left in the containers after 5 days.

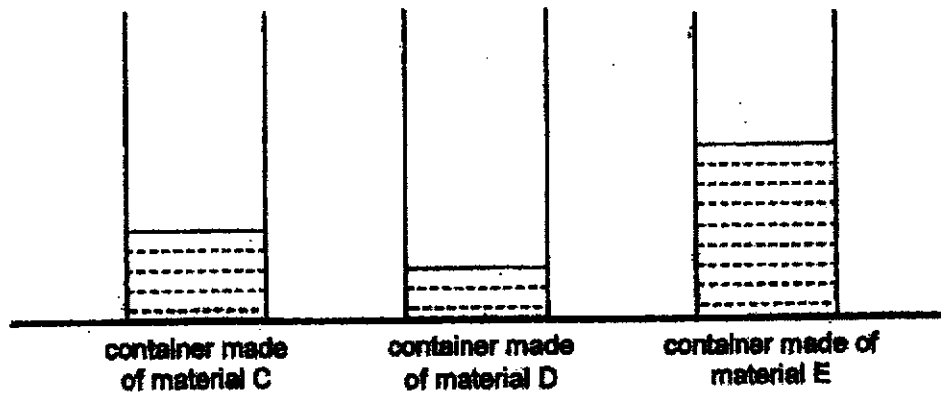

Based on her results, which material is the best conductor of heat? Explain why.

[2]

3

Score	2
-------	---

31. The diagram below shows the cross-section of a flower.

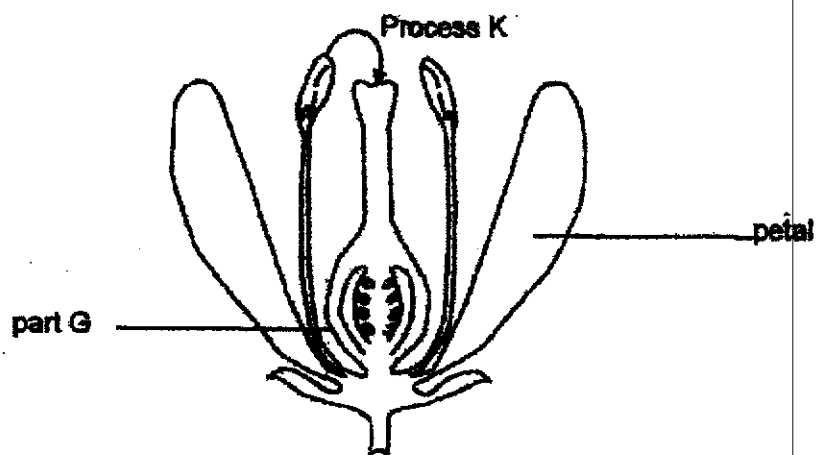

a) Based on the diagram above, state process K. [1]

b) Describe the process that takes place in part G after process K? [1]

c) What happens to part G after the process stated in (b)? [1]

4

Score	3
-------	---

32. a) State two properties of matter. [1]

Property 1: _____

Property 2: _____

b) In the diagram below, a little girl is playing her violin on stage.

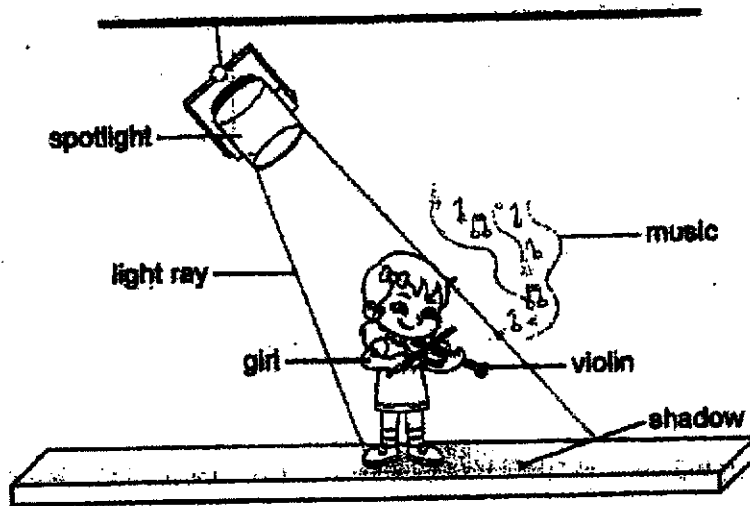

Based on the diagram above, put a (✓) under the correct heading to indicate if they are 'matter' or 'non-matter'. [1]

	Matter	Non-Matter
girl		
violin		
music		
light ray		
shadow		
spotlight		

Score	2
-------	---

33. Lucian made a model of the human respiratory system as shown below.

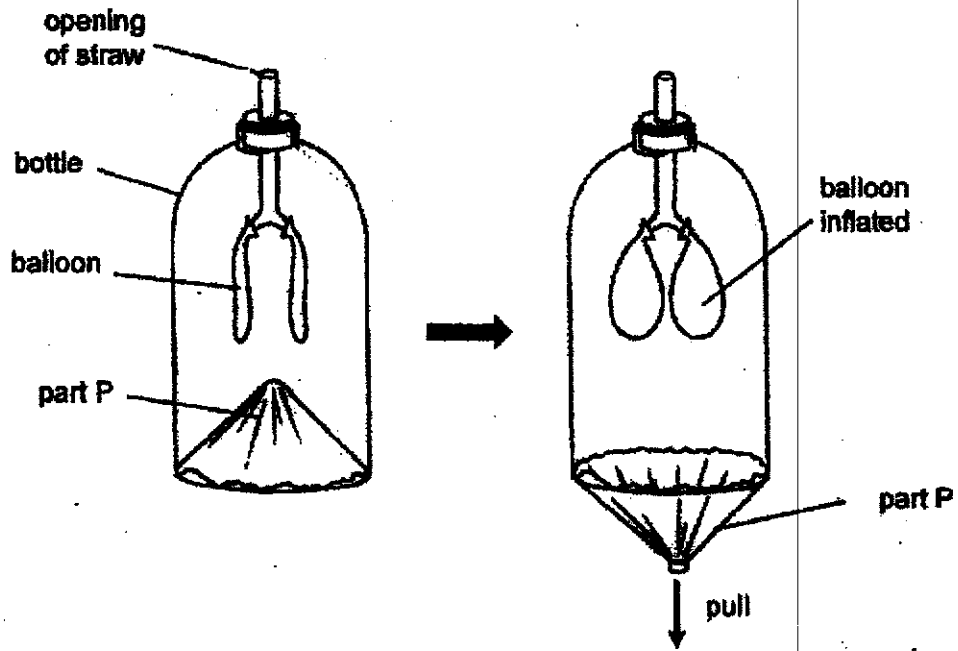

a) Which part of the model above represents the following body parts? [1]

i. lung: _____

ii. ribcage: _____

b) As seen in the diagram above, the balloons inflate when Lucian pulls Part P down. Explain why. [1]

Score	2
-------	---

The diagram below shows air entering the human respiratory system through the nose and travelling through the nasal cavity.

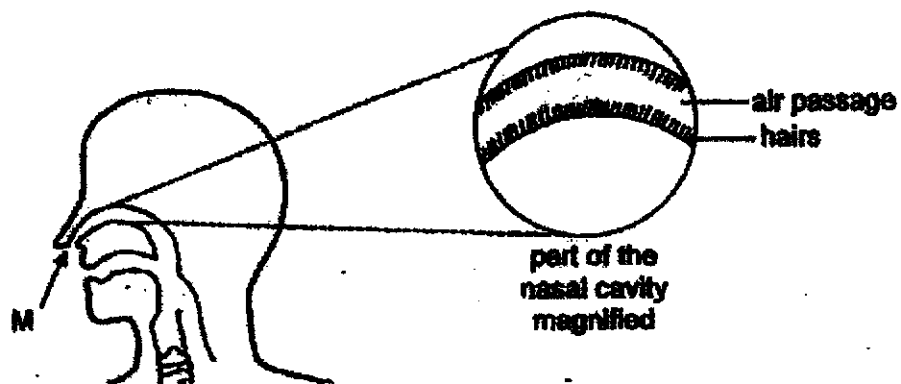

- c) Give a reason how the hairs shown above will benefit a human respiratory system. [1]

- d) Lucian is in an air-conditioned classroom. Explain why the air he breathes out is warmer than the air he breathes in. [1]

7

Score	2
-------	---

34. A farmer removed the food-carrying tubes of a plant, at positions, R, S and T, at the time when fruit P and Q appeared. Both fruit were of the same size.

The diagram below shows what the farmer observed after three weeks.

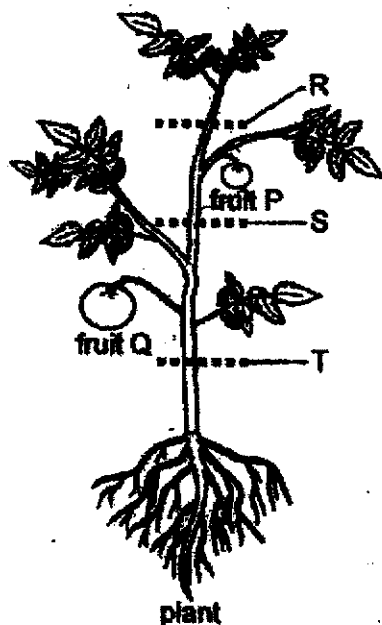

- a) Explain why fruit Q grew bigger than fruit P.

[2]

- b) The farmer then made a deeper cut at position T, removing the water-carrying tubes. She observed that all the leaves of the plant started to wilt after some time. Suggest a reason for this observation.

[1]

8

Score	3
-------	---

35. Study the flowchart below.

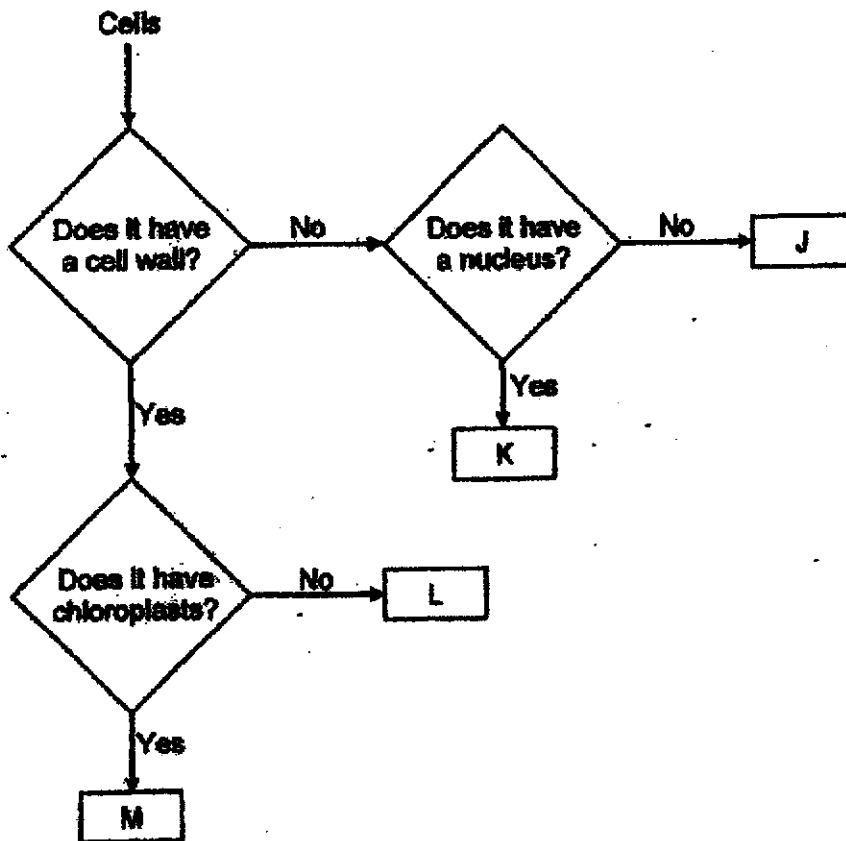

a) Based on the flowchart above, fill the blanks with the letters, J, K L or M, in the table below. [1]

Type of cell	Letter
Onion	
Human Cheek	

b) Based on the flowchart above, which cell(s) above cannot reproduce? Explain why. [1]

9

Score	2
-------	---

36. The diagram below shows the life cycle of animal A, which spreads disease R to humans when it is in its adult stage.

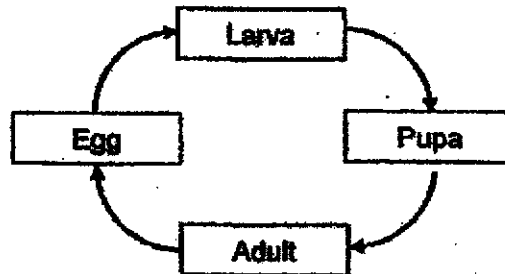

A researcher kept some animal A at different temperatures and observed its life cycles. The results are shown in the table below.

Duration of each stage at different surrounding temperatures (days)				
	22°C	28°C	30°C	34°C
Egg	15	10	8	4
Larva	6	6	6	6
Pupa	8	8	8	8
Adult	9	12	14	17

- a) Based on the results above, which stage(s) of the life cycle of animal A is/ are not affected by the changes in the surrounding temperature? [1]
-
- b) The researcher kept some freshly laid eggs of animal A in a container in her room. Animal A was a larva on Day 15. Based on the results, suggest a possible temperature of the room. [1]
-
- c) Based on the results above, suggest a reason why disease R spreads the most quickly when the surrounding temperature is at 34°C. [1]
-

10

Score	3
-------	---

37. Kim wanted to investigate the magnetic strength of four bars, W, X, Y and Z. The bars were made of different materials.

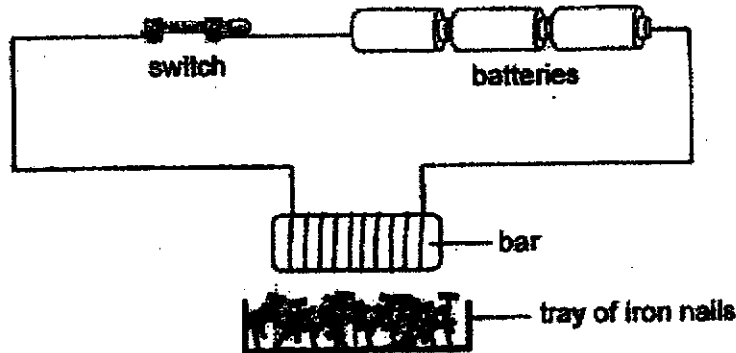

There were fifty iron nails in the tray at the start of the experiment. When the switch was closed, the number of nails left in the tray was recorded in the table below.

Bar	Number of iron nails left in the tray
W	39
X	35
Y	32
Z	25

- a) Based on the table above, which bar was the strongest electromagnet? Explain your answer. [1]
- _____
- _____
- b) Suggest two variables she needed to keep constant for the experiment. [2]
- _____
- _____
- c) Kim repeated the experiment with the same set-up but using another bar, A. She observed that there were fifty iron nails in the tray when the switch was closed. Based on this observation, what can you conclude about bar A? [1]
- _____

Score	4
-------	---

- 38 Thomas conducted an experiment using the set-up below. He dropped 50-cent coins, one at a time, into the pail. The pail started to move downwards when the 20th coin was added.

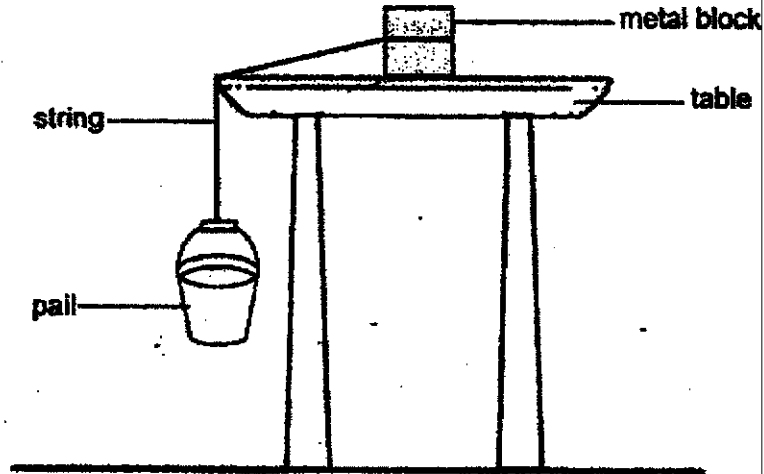

- a) Identify the force that caused the metal block to move.

[1]

- b) When oil was applied onto the table's surface, fewer coins were required to move the metal block? Explain why.

[1]

12

Score	2
-------	---

Thomas conducted another experiment with four metal blocks, F, G, H and J. His results are shown in the table below.

Metal block	Area of contact with the table (cm ²)	Mass of the block (g)	Number of coins needed to move the block
F	16	150	40
G	49	70	20
H	49	150	40
J	16	50	15

Thomas concludes that the area of contact with the table will not affect the number of coins that fall in the pail.
is needed to move the block

- c) Based on the table above, which two metal blocks did he use to arrive at this conclusion. Explain your answer. [2]

- d) Thomas took three readings for each metal block. How does doing this affect his results? [1]

Score	3
-------	---

39. Sarah set up the following experiment to investigate how the colour of light affects the rate of photosynthesis of a water plant.

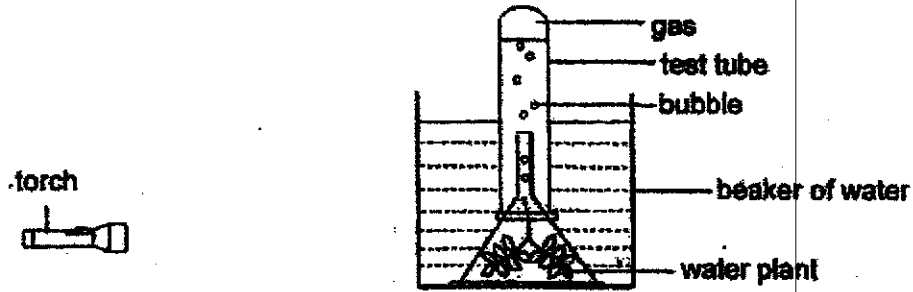

She counted the number of bubbles produced in one minute for each colour.

Colour of light	Number of bubbles produced in one minute
red	28
green	5

a) Besides counting the number of bubbles, what could Sarah measure to conclude how the colour of the light affects the rate of photosynthesis? [1]

b) Without adding or removing any items to the set-up, what can Sarah do to increase the rate of photosynthesis when using the red light? [1]

Score	2
-------	---

Sarah made a sealed terrarium as shown below.

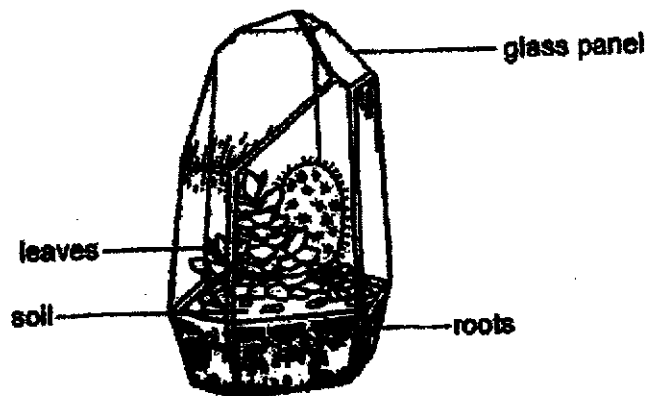

- c) Based on the results of her experiment, which colour of light should she choose to shine at the plants such that they can grow the most?
 Explain your answer. [1]

- d) Explain how the plants in the sealed terrarium have a continuous supply of water to survive. [2]

Score	3
--------------	---

40. Faridah hung ball A with a string above a bell, as shown below. When the string was cut, the ball dropped and hit the bell below it. She measured the loudness of the sound with the microphone and a data logger.

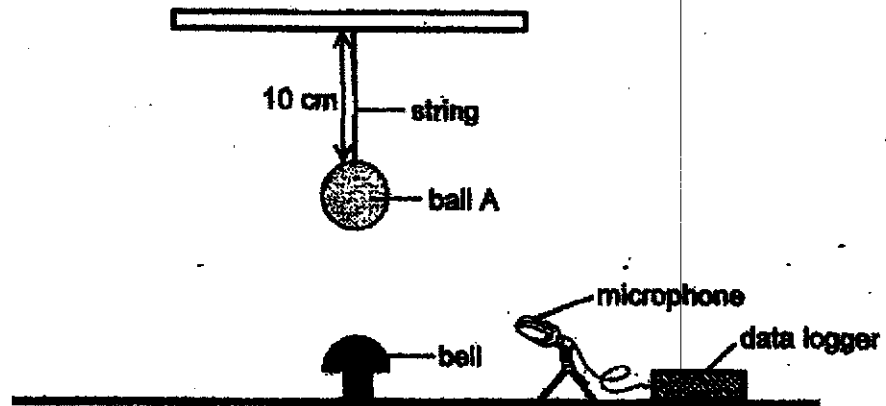

She then repeated the experiment with balls of different masses, B, C and D, and using different lengths of string.

Her results are shown in the table below.

Ball	Mass of ball (g)	Length of string (cm)	Loudness of sound (units)
A	100	10	50
B	200	10	60
C	300	10	80
D	300	5	90

- a) Fill in the boxes below to show the energy conversion when the string was cut for ball A. [1]

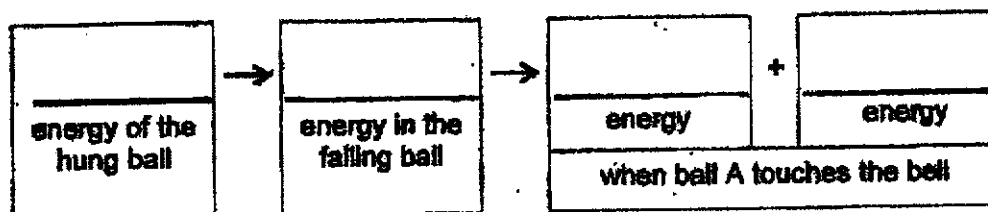

- b) What can Faridah conclude about the relationship between the loudness of the sound produced by the bell and the mass of the ball? [1]

- c) Based on the results, ball D made the loudest sound. Explain why. [2]

Score	4
--------------	---

41. When a car with mass above 1700 kg drives onto a sense pad, electricity would flow through a device, D, which would lift the barrier to allow the car to drive on.

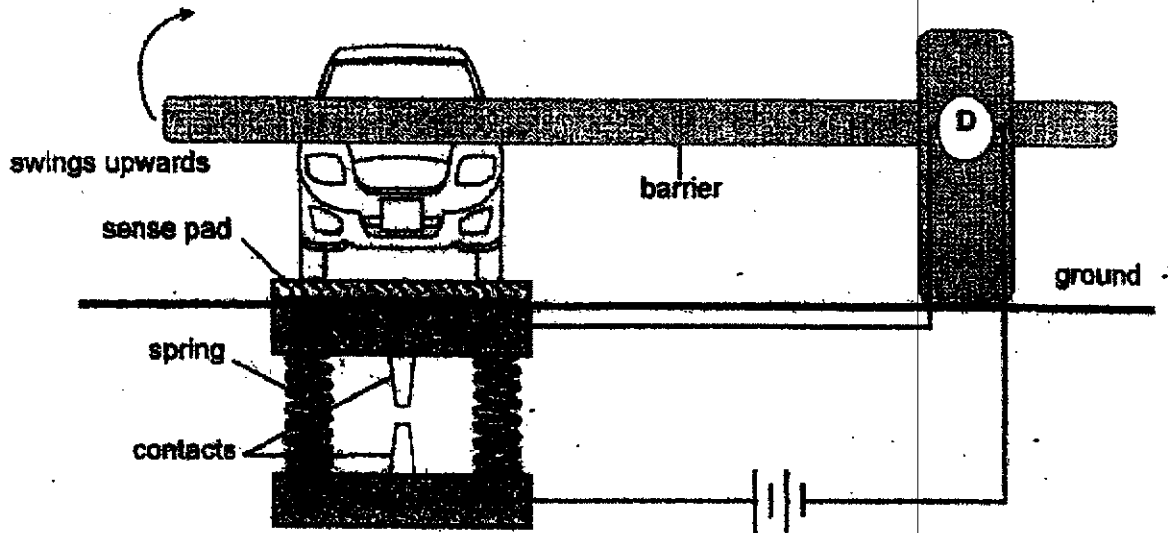

- a) Explain how the car, when moving over the sense pad, will cause the barrier to swing up. [2]

Score	2
-------	---

- b) Suggest a change to the above set-up so that the barrier can be lifted up even for a car with a mass of 1500 kg. [1]

- c) Explain how your suggestion in (b) would work. [1]

End of Booklet B

Score	2
-------	---

ANSWER KEY

YEAR : 2021
LEVEL : PRIMARY 6
SCHOOL : TAO NAN
SUBJECT : SCIENCE
TERM : PRELIMINARY

BOOKLET A

Q1	4	Q2	2	Q3	4	Q4	4	Q5	3
Q6	2	Q7	3	Q8	1	Q9	4	Q10	2
Q11	4	Q12	3	Q13	2	Q14	4	Q15	1
Q16	2	Q17	2	Q18	1	Q19	4	Q20	4
Q21	3	Q22	1	Q23	3	Q24	1	Q25	1
Q26	1	Q27	4	Q28	3				

BOOKLET B

Q29	a) To find out if the amount of water affects mould growth. b) Decomposition c) If both muffins had been placed in a freezer for a week, mould not grow on the moist muffins as warmth is needed for mould to grow.																					
Q30	Material D. It has the least amount of water as it evaporates the fastest.																					
Q31	a) Pollination b) The male reproductive cell will fuse with the female reproductive cell. c) G will become a fruit.																					
Q32	a) Property 1: Matter has mass Property 2: Matter has volume b) <table border="1" style="margin-left: 20px;"> <thead> <tr> <th></th><th>Matter</th><th>Non-Matter</th></tr> </thead> <tbody> <tr> <td>Girl</td><td style="text-align: center;">√</td><td></td></tr> <tr> <td>Violin</td><td style="text-align: center;">√</td><td></td></tr> <tr> <td>Music</td><td></td><td style="text-align: center;">√</td></tr> <tr> <td>Light ray</td><td></td><td style="text-align: center;">√</td></tr> <tr> <td>Shadow</td><td></td><td style="text-align: center;">√</td></tr> <tr> <td>Spotlight</td><td style="text-align: center;">√</td><td></td></tr> </tbody> </table>		Matter	Non-Matter	Girl	√		Violin	√		Music		√	Light ray		√	Shadow		√	Spotlight	√	
	Matter	Non-Matter																				
Girl	√																					
Violin	√																					
Music		√																				
Light ray		√																				
Shadow		√																				
Spotlight	√																					
Q33	a) i. lung : Ballon ii. ribcage : Bottle																					

	<p>b) Air from the surrounding enters the straw and rushes in to occupy space in the bottle.</p> <p>c) The hairs at the air passage prevents dirt to pass through.</p> <p>d) The air breathed in gained heat from the body.</p>
Q34	<p>a) The part in-between position sand T had more leaves to make food for fruit Q, while fruit P has only a few leaves to help make food as it could not be transported above or below the cuts S and T.</p> <p>b) Water cannot be transported to the leaves.</p>
Q35	<p>a) Onion : L Human cheek : K</p> <p>b) Cell J. It does not have genetic information and cannot control all activities in the cell.</p>
Q36	<p>a) Larva and pupa</p> <p>b) 26°C</p> <p>c) It has the longest adult stage.</p>
Q37	<p>a) Bar Z. The number of iron nails attracted is the most.</p> <p>b) 1. The number of batteries. 2. The number of coils around the bar.</p> <p>c) Bar A is a non-magnetic material.</p>
Q38	<p>a) Gravitational force.</p> <p>b) There was lesser friction between the table and the metal block so less ^(gravitational) gravitation force is needed to move the block.</p> <p>c) F and H. They have different areas of contact with the table but the mass of the block is the same and the same number of coins was needed to move the block.</p> <p>d) This ensures that the results are reliable.</p>
Q39	<p>a) Measure the height of the water in the test tube.</p> <p>b) Increase the brightness of the torch.</p> <p>c) Red light. As the number of bubbles produces the most.</p> <p>d) Water vapour from the soil comes into contact with the cooler inner glass, condense to form water droplets, which full back the soil.</p>
Q40	<p>a) Gravitational potential → kinetic → heat + sound</p> <p>b) The larger the mass of the ball, the louder the sound produced by the bell.</p> <p>c) Ball D has more gravitational potential energy which was converted to more kinetic energy.</p>
Q41	<p>a) When the car is on the sense pad, the weight of the car compress the spring. The contacts touch each other forming a close circuit causing electricity to flow through the circuit.</p> <p>b) Make the contacts closer to each other. / Allow the spring to be lower.</p> <p>c) Less weight will be needed to compress the spring to the same length.</p>

2
END