



Rosyth School
Term Assessment 2024 (Term 2)
Mathematics
Primary 6
Paper 1

Name: _____

Register No. _____

Class: Pr 6 - _____

Date: 3 May 2024

Parent's Signature: _____

Total Time for Booklets A and B : 1 hour

BOOKLET A

Instructions to Pupils:

1. Do not open this booklet until you are told to do so.
2. Follow all instructions carefully.
3. Shade your answers in the Optical Answer Sheet (OAS) provided.
4. You are **not** allowed to use a calculator.
5. Answer all questions.

Section	Maximum Mark	Marks Obtained
Paper 1 (Booklet A)	20	

* This booklet consists of 7 pages (including this cover page).

Questions 1 to 10 carry 1 mark each. Questions 11 to 15 carry 2 marks each. For each question, four options are given. One of them is the correct answer. Make your choice (1, 2, 3 or 4). Shade the oval (1, 2, 3 or 4) on the Optical Answer Sheet.

All diagrams in this paper are not drawn to scale unless stated otherwise.

(20 marks)

1. Round 132 658 to the nearest thousand.

- (1) 132 000
- (2) 132 600
- (3) 132 700
- (4) 133 000

2. What does the digit 9 in 5.492 stand for?

- (1) 9 ones
- (2) 9 tenths
- (3) 9 hundredths
- (4) 9 thousandths

3. In the figure below, PQRU and RSTU are rhombuses. Which of the following pairs of lines are parallel?

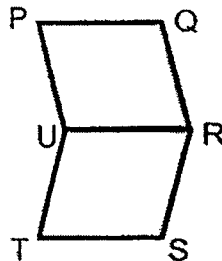

- (1) PQ and RS
- (2) PQ and TS
- (3) UT and PU
- (4) UT and UR

4. Mark and John collected some stickers. Mark collected $\frac{5}{8}$ of the total number of stickers. What is the ratio of Mark's stamps to John's stickers?
- (1) 3 : 5
(2) 3 : 8
(3) 5 : 3
(4) 5 : 8
5. Sherry scored an average of 30 points for 5 basketball games. What is the total number of points that Sherry scored for the 5 basketball games?
- (1) 6
(2) 25
(3) 35
(4) 150
6. The table below shows the number of pupils in four classes.

Class	Number of Boys	Number of Girls
6A	15	25
6B	18	23
6C	22	17
6D	20	22

What is the total number of pupils in Class 6B?

- (1) 39
(2) 40
(3) 41
(4) 42

7. What is the value of 0.63×200 ?

- (1) 0.126
- (2) 1.26
- (3) 12.6
- (4) 126

8. In the figure below, not drawn to scale, ABCD is a four-sided figure made up of a rhombus ABCE and an equilateral triangle AED. Find $\angle ABC$.

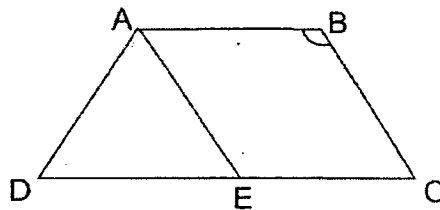

- (1) 60°
- (2) 90°
- (3) 120°
- (4) 150°

9. The figure below shows a semi-circle. Find the perimeter of the figure.

(Take $\pi = \frac{22}{7}$)

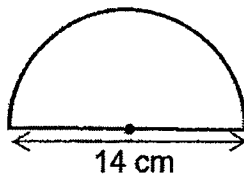

- (1) 22 cm
- (2) 36 cm
- (3) 44 cm
- (4) 58 cm

10. Arrange these fractions from the smallest to the largest.

$$\frac{8}{5}, \quad 1\frac{3}{10}, \quad \frac{7}{4}$$

- | | <u>Smallest</u> | | <u>Largest</u> |
|-----|-------------------|-------------------|-----------------|
| (1) | $\frac{7}{4}$, | $1\frac{3}{10}$, | $\frac{8}{5}$ |
| (2) | $1\frac{3}{10}$, | $\frac{8}{5}$, | $\frac{7}{4}$ |
| (3) | $\frac{8}{5}$, | $\frac{7}{4}$, | $1\frac{3}{10}$ |
| (4) | $\frac{7}{4}$, | $\frac{8}{5}$, | $1\frac{3}{10}$ |

11. In the figure below, WXV is a triangle and VXZ is a straight line. $\angle WXY$ is twice of $\angle YXZ$. Find $\angle WXY$.

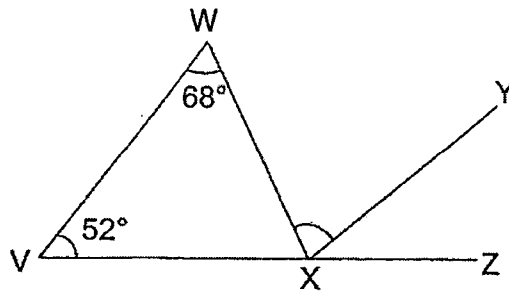

- (1) 30°
 (2) 40°
 (3) 60°
 (4) 80°

12. Aisha baked an equal number of chocolate muffins and banana muffins. She gave Liling 28 chocolate muffins and 10 banana muffins. She gave the remaining muffins to Jane. Jane received 1 chocolate muffins for every 4 banana muffins. How many muffins did Aisha baked at first?

- (1) 18
 (2) 24
 (3) 34
 (4) 68

13. The figure below is made up of 2 squares, a rectangle and a triangle. Find the unshaded area of the figure.

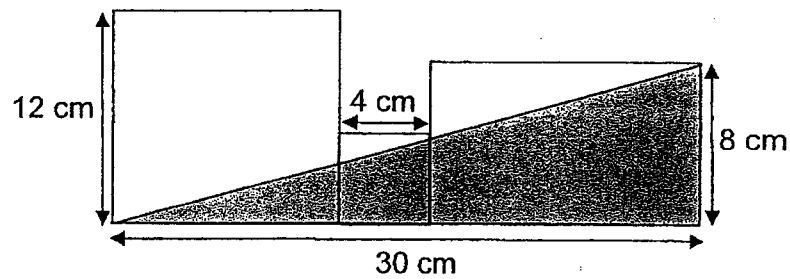

- (1) 120 cm^2
 (2) 152 cm^2
 (3) 240 cm^2
 (4) 272 cm^2

14. The figure below shows a box which can contain exactly 8 identical cubes. The volume of all the cubes is 216 cm^3 . What is the length of a cube?

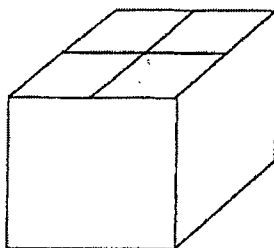

- (1) 6 cm
(2) 9 cm
(3) 3 cm
(4) 27 cm
15. Samad bought some fruits. $\frac{3}{5}$ of the fruits he bought were apples and the rest were oranges. $\frac{1}{6}$ of the oranges and $\frac{1}{3}$ of the apples that he bought were rotten. 240 of the fruits were rotten. What is the total number of oranges that Samad bought?

- (1) 60
(2) 144
(3) 360
(4) 900



Rosyth School
Term Assessment 2024 (Term 2)
Mathematics
Primary 6
Paper 1

Name: _____

Register No. _____

Class: Pr 6 - _____

Date: 3 May 2024

Parent's Signature: _____

Total Time for Booklets A and B : 1 hour

BOOKLET B

Instructions to Pupils:

1. Do not turn over this page until you are told to do so.
2. Follow all instructions carefully.
3. Answer all questions.
4. Use a dark blue or black ballpoint pen to write your answers in the space provided for each question.
5. Do not use correction fluid/tape or highlighters.
6. You are **not** allowed to use a calculator.

Section	Maximum Mark	Marks Obtained
Paper 1 (Booklet B)	25	

* This booklet consists of **10** pages (including this cover page).

Questions 16 to 20 carry 1 mark each. Write your answers in the spaces provided. For questions which require units, give your answers in the units stated.

Do not write in this space

All diagrams in this paper are not drawn to scale unless stated otherwise.

(5 marks)

16. Find the value of $3j + 23$ when $j = 14$.

Ans: _____

17. Name all the figures below with at least 1 line of symmetry.

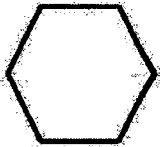

Figure A

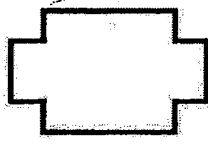

Figure B



Figure C

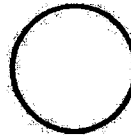

Figure D



Figure E

Ans: _____

18. Find the value of $\frac{2}{5} \div 8$.

Express your answer as a fraction in its simplest form.

Ans: _____

19. In this month, Colin sold 200 more handphones than he sold the previous month. This was a 40% increase from the number of handphones he had sold the previous month. How many handphones did he sell this month?

Do not write in this space

Ans: _____

20. Kelly faces the supermarket after turning 135° in an anti-clockwise direction.

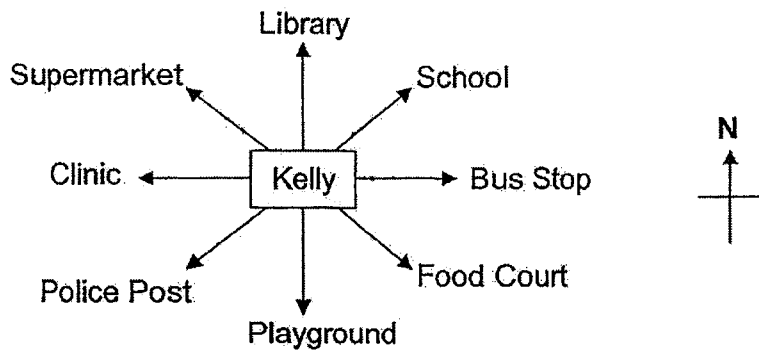

Where was she facing at first?

Ans: _____

Questions 21 to 30 carry 2 marks each. Show your workings clearly in the space provided for each question and write your answers in the spaces provided. For questions which require units, give your answers in the units stated.

Do not write in this space

All diagrams in this paper are not drawn to scale unless stated otherwise.
 (20 marks)

21. Kumar used some wires to make the following figure. The figure is made up of 3 semi-circle arcs and an equilateral triangle. Line XY is 10 cm and line YZ is 30 cm. Find the total length of the wires he used.
 (Take $\pi = 3.14$)

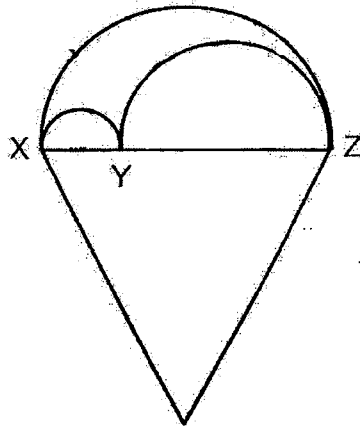

Ans: _____ cm

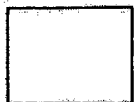

22. Students were asked to choose their favourite sport. The bar graph below shows the choices made by the students.

Do not write
in this space

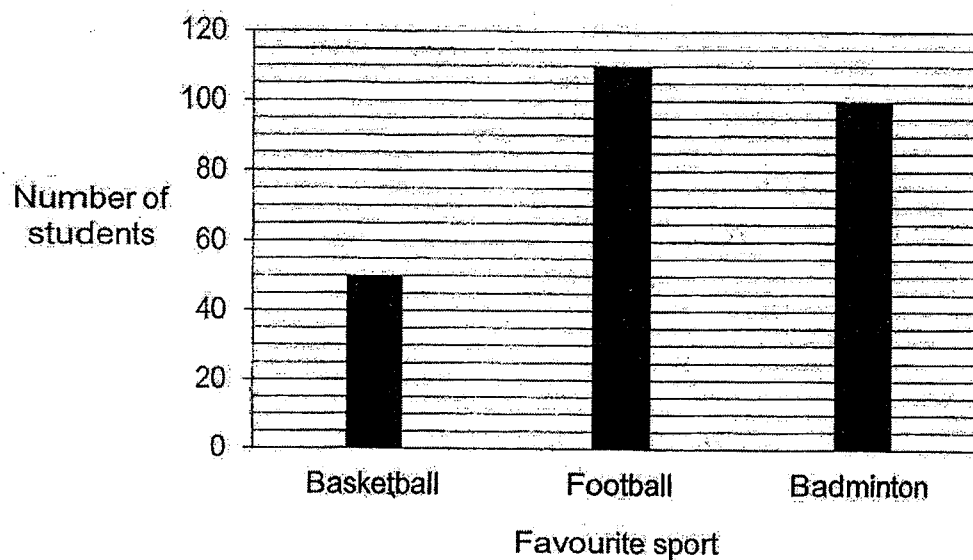

What fraction of students chose Badminton as their favourite sport? Express the fraction in its simplest form.

Ans: _____



23. A rectangular piece of paper was folded along AB and CD to form the figure as shown below. $\angle GBF = 80^\circ$ and $\angle AEF = 70^\circ$. Find $\angle BFD$.

Do not write in this space

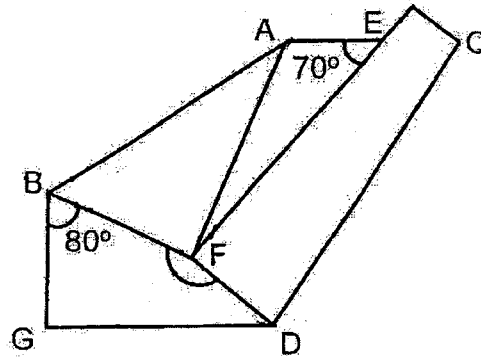

Ans: _____°

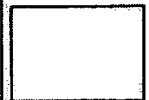

24. A rectangular cardboard, with patterns on one side, is folded to form the shape below. Find the area of the cardboard when unfolded.

Do not write
in this space

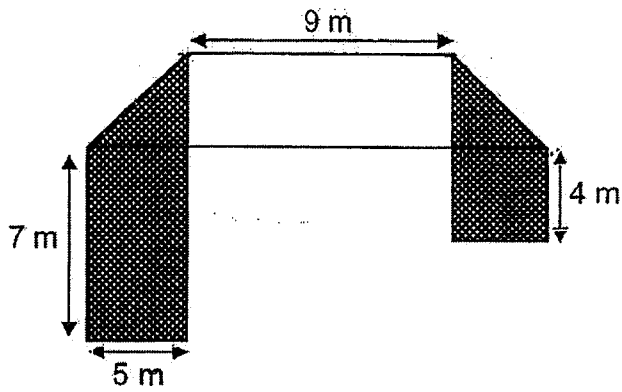

Ans: _____ m²

25. The ratio of the number of pens that David had to the number of pens that Paul had was 3 : 5. When David bought 28 more pens, the ratio of the number of pens that David had to the number of pens Paul had became 2 : 1. How many pens did Paul have?

Ans: _____

26. The figure below shows a container that is $\frac{1}{3}$ filled with water. Another 42 litres of water will fill the container to the brim. What is the height of the container?

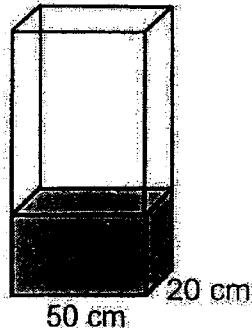

Do not write
in this space

Ans: _____ cm

27. There are some beads in a box. The beads can be placed in bags of 6 and 8 with no beads leftover. When the beads are put into bags of 10, there will be 2 beads leftover. What is the smallest number of beads in the box?

Ans: _____

28. Kartini had a bottle of juice. She drank an equal amount of the juice each day. At the end of the 3rd day, she had 1320 millilitres of the juice left. At the end of the 7th day, she had half the bottle of juice left. How many litres of juice was there in the bottle at first?

Do not write
in this space

Ans: _____

29. Adam had \$48 more than David. When David gave Adam \$21, Adam had four times as much money as David. How much money did David have at first?

Ans: \$ _____

30. The tank contained some water at first. Tap A was turned on to fill the tank with water at a constant rate. After 4 minutes, Tap B was turned on to drain water out of the tank at a constant rate.

Do not write in this space

The graph below shows the volume of water in the tank during the 8-minute period.

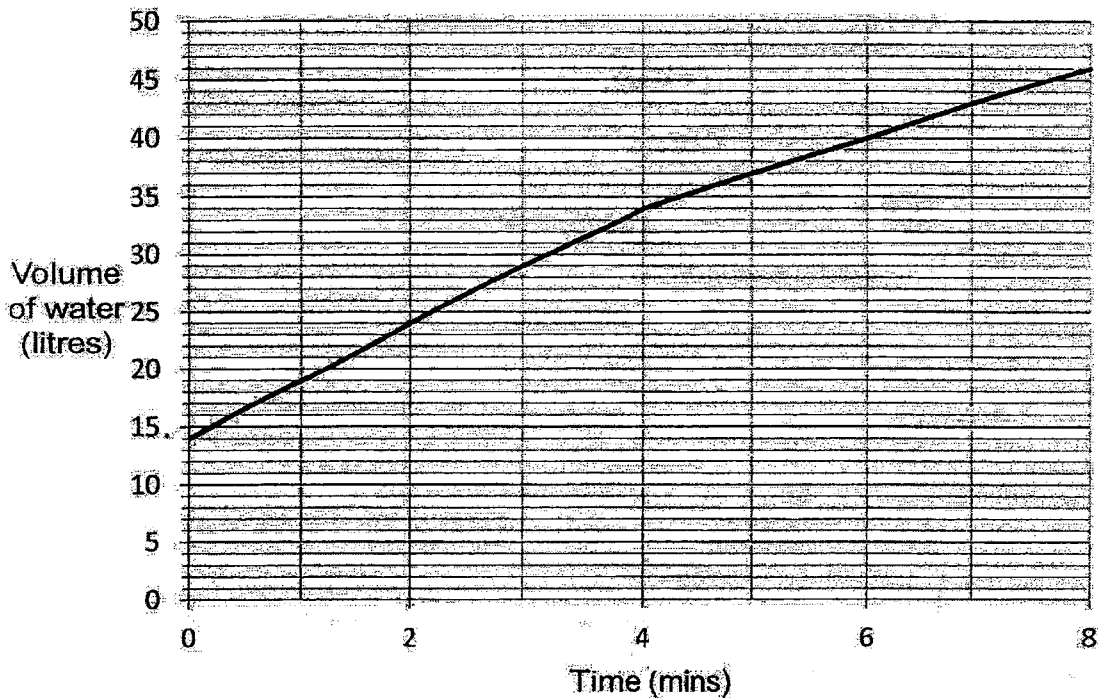

Each of the statements is either true, false or not possible to tell from the information given. For each statement, put a tick (✓) to indicate your answer.

Statement	True	False	Not possible to tell
Tap B drained water out of the tank at a rate of 2.5 litres/min.			
The capacity of the tank is 46 litres.			



End of paper
Have you checked your work?



Rosyth School
Term Assessment 2024 (Term 2)
Mathematics
Primary 6
Paper 2

Name: _____

Register No. _____

Class: Pr-6 - _____

Date: 3 May 2024

Parent's Signature: _____

Time: 1 h 30 min.

Instructions to Pupils:

1. Do not turn over this page until you are told to do so.
2. Follow all instructions carefully.
3. Answer all questions.
4. Use a dark blue or black ballpoint pen to write your answers in the space provided for each question.
5. Do not use correction fluid/tape or highlighters.
6. The use of an approved calculator is allowed.

Questions	Maximum Mark	Marks Obtained
Q 1 to 5	10	
Q 6 to 17	45	

Section	Maximum Mark	Marks Obtained
Paper 1	45	
Paper 2	55	
Total	100	

* This booklet consists of 16 pages (including this cover page)

Questions 1 to 5 carry 2 marks each. Show your working clearly in the space provided for each question and write your answers in the spaces provided. For questions which require units, give your answers in the units stated.

Do not write
in this space

(10 marks)

All diagrams in this paper are not drawn to scale unless stated otherwise.

1. Joe has two rectangular boxes of different sizes. The length, breadth and height of the larger box are twice those of the smaller box. He packed 48 identical cubes exactly into the smaller box. How many such cubes can be packed exactly into the larger box?

Ans: _____

2. The ratio of Amy's present age to Samantha's present age is 4 : 7. 10 years ago, the ratio of Amy's age to Samantha's age was 1 : 3. What is Samantha's present age?

Ans: _____

3. Ken completed a race in 160 seconds. He was 45 seconds slower than Raju. Hassan was 10 seconds faster than Raju. How long, in minutes and seconds, did Hassan take to complete the race?

Do not write
in this space

Ans: _____ min _____ s

-
4. Wendy can make $(3n + 4)$ muffins in one day. Katelyn can make $4n$ more muffins than Wendy in one day. Katelyn and Wendy can make a total of 128 muffins in one day. Find the value of n .

Ans: _____

5. Jane parked her car at a car-park from 12.35 pm to 5.20 pm. The parking rates are shown in the table below. How much did she have to pay for parking?

Do not write in this space

First hour	\$4.60
Every 30 minutes or part thereof	\$2.00

Ans: \$ _____

For Questions 6 to 17, show your working clearly in the space provided for each question and write your answers in the spaces provided. The number of marks available is shown in brackets [] at the end of each question or part-question. For questions which require units, give your answers in the units stated. (45 marks)

Do not write
in this space

All diagrams in this paper are not drawn to scale unless stated otherwise.

6. A trapezium JKLM is drawn on a square grid inside a box.

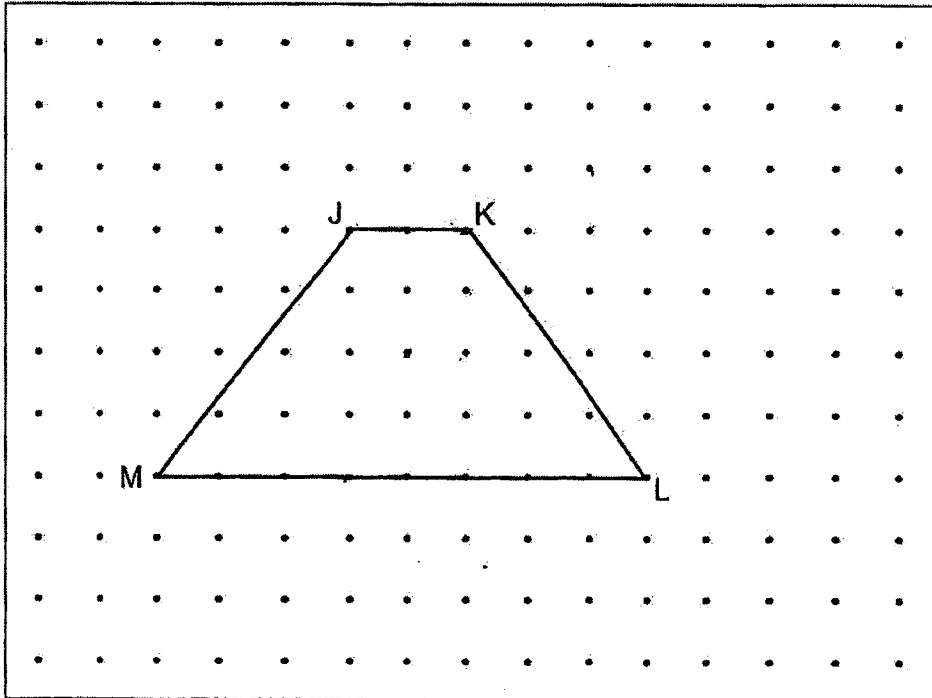

By joining dots on the grid with straight lines, draw a triangle KLP such that its area is half the area of the trapezium JKLM. [3]



7. Kovan Primary School is having a musical. Mrs Teo is in charge of printing invitation cards needed by each group for the musical.

Do not write in this space

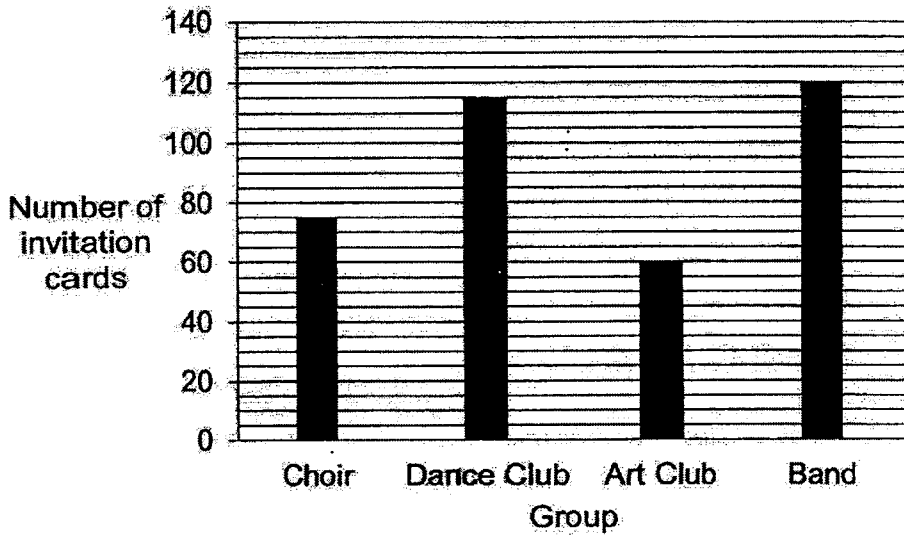

The table below shows the cost of printing invitation cards at a printing shop.

Printing Charges	
First 200 cards	\$2.00 each
Next 100 cards	\$1.50 each
Every additional card	\$0.60 each

How much did Mrs Teo have to pay for the total number of invitation cards printed for the four groups?

Ans: _____ [3]

8. The ratio of the number of adults to the number of children at a concert was 5 : 3. The price of one adult ticket was \$45 while the price of a child ticket was \$23. The total amount of money collected from the sale of tickets was \$5292. How many adults attended the concert?

Do not write
in this space

Ans: _____ [3]

9. Mr Samad spent $\frac{1}{6}$ of his money on 2 shirts and 3 jackets. Each jacket cost twice as much as each shirt. He then spent $\frac{2}{5}$ of his remaining money on a wallet. He spent \$23.80 more on the wallet than on the 2 shirts. How much money did Mr Samad have at first?

Do not write
in this space

Ans: _____ [3]

10. The bar graph shows the number of pens donated by Class 6K from January to April. The number of pens donated is not shown on the scale.

Do not write
in this space

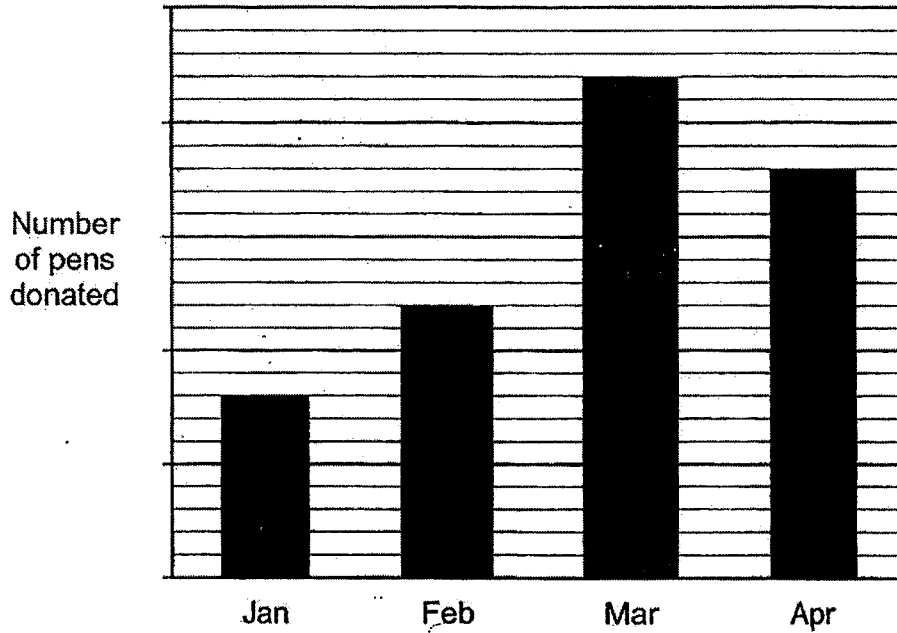

- (a) What was the percentage increase in the number of pens donated from January to February?

Ans: _____ [1]

- (b) The average number of pens donated in a month from January to April was 45. How many pens did Class 6K donate in April?

Ans: _____ [2]

11. ABCD is a square and PQSD is a parallelogram. RSC and SDC are isosceles triangles. $RS = RC$ and $SC = SD$. $\angle SRC = 82^\circ$.

Do not write
in this space

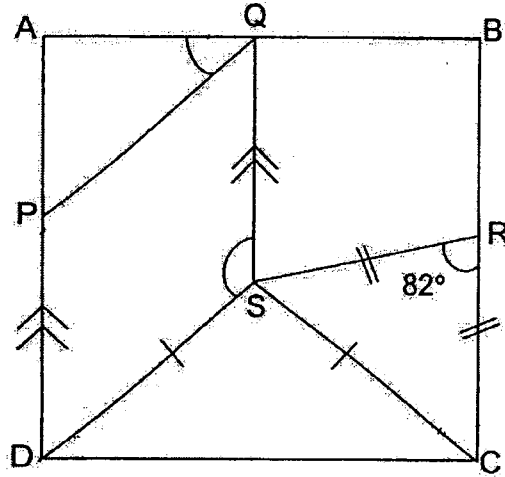

(a) Find $\angle QSD$.

Ans: (a) _____ [2]

(b) Find $\angle AQP$.

Ans: (a) _____ [2]

12. Rianne had some beads. She gave $\frac{2}{9}$ of her beads to her mother. Her sister then took $\frac{1}{5}$ of her remaining beads and an additional 22 beads. Rianne was then left with 34 beads. How many beads did Rianne have at first?

Do not write
in this space

Ans: _____ [4]

13. The tap was turned on for 40 minutes to fill the empty cubical tank to the brim as shown in the diagram below. Then some water in the tank was poured to fill 180 bottles of 150 cm^3 each completely. In the end, there was 5.768 litres of water left in the tank.

Do not write in this space

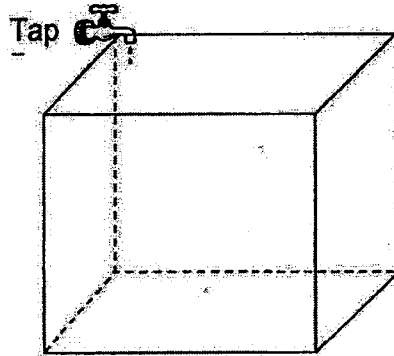

(a) What was the side of the cubical tank?

Ans: (a) _____ [2]

(b) How many cm^3 of water was flowing out of Tap A in a minute?

Ans: (b) _____ [2]

14. In the figure below, LGC is a straight line. ABC is an equilateral triangle and DEFG is a square. DJ is parallel to AB. $\angle DGL = 40^\circ$ and $\angle EJK = 58^\circ$.

Do not write in this space

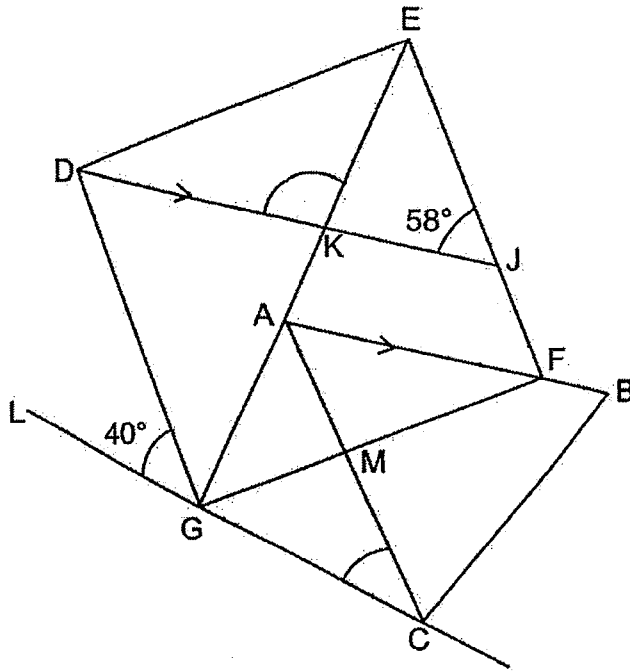

(a) Find $\angle DKE$.

Ans: (a) _____ [2]

(b) Find $\angle ACG$.

Ans: (b) _____ [2]

15. Matthew had \$72 more than Cayden. Matthew spent 90% of his money and Cayden spent 40% of his. In the end, Cayden has twice as much money as Matthew. How much money did Matthew have at first?

Do not write
in this space

Ans: _____ [4]

16. The pattern below is made up of shaded and unshaded squares.

Do not write in this space.

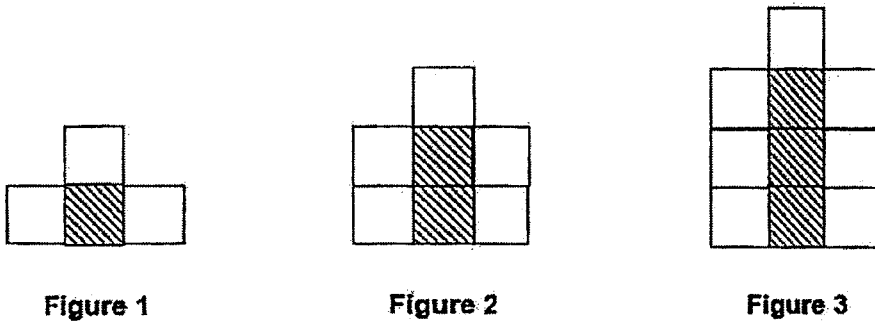

The table below shows the number of shaded squares, unshaded squares and total number of squares for each figure.

Figure Number	Number of Shaded Squares	Number of Unshaded Squares	Total Number of Squares
1	1	3	4
2	2	5	7
3	3	7	10
4	4	9	13
...
10	10	(a) _____	(a) _____

[1]

- (a) Complete the table by indicating the number of unshaded squares and total number of squares for Figure 10.
- (b) Find the total number of squares in Figure 22.

Ans: (b) _____ [2]

- (c) What Figure Number has 79 unshaded squares?

Ans: (c) _____ [2]

17. The figure is made up of 4 identical circles of diameter 30 cm inside a larger circle with a diameter of 72 cm. Find the total area of all the shaded parts.

(Take $\pi = \frac{22}{7}$)
3.14

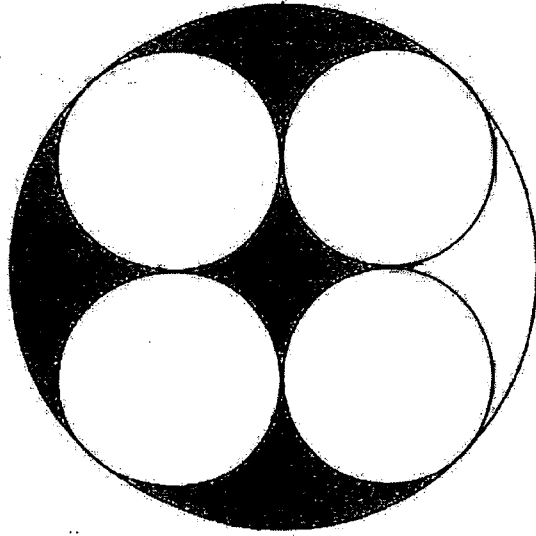

Do not write
in this space

Ans: _____ [5]



End of paper
Have you checked your work?

SCHOOL : ROSYTH SCHOOL
LEVEL : PRIMARY 6
SUBJECT : MATH
TERM : 2024 WA2

Q1	Q2	Q3	Q4	Q5	Q6	Q7	Q8	Q9	Q10
4	3	2	3	4	3	4	3	2	2
Q11	Q12	Q13	Q14	Q15					
4	4	2	3	3					

16)	65
17)	A,B,D
18)	$\frac{1}{20}$
19)	700
20)	Bus Stop
21)	$3.14 \times 40 \times \frac{1}{2} = 3.14 \times 2 = 62.8$ $62.8 \times 2 + 40 \times 3$ $= 125.6 + 120 = 245.6\text{cm}$
22)	Total $\rightarrow 50 \times 110 + 100$ $= 160 + 100 = 260$ Fraction $\rightarrow \frac{100}{200} = \frac{5}{13}$
23)	170°
24)	150m ²
25)	20
26)	63cm
27)	72
28)	1.68
29)	\$51
30)	False Not possible to tell

Rosyth Primary School 2024 Math Term 2

Paper 2

- Q1) 1 big box = $2 \times 2 \times 2$
 $= 8$ (small boxes)
 1 small box = 48 cubes
 8 small boxes = (48×8) cubes
 $= 384$ cubes //

Q2) $A : S : Diff$
 $4 : 7 : 3$
 $\begin{array}{r} -10 \quad -10 \\ \hline 1 : 3 : 2 \end{array}$ $\times 2$
 $\begin{array}{r} 8 : 14 : 6 \end{array}$ $\times 3$
 $3 : 9 : 6$ \leftarrow

$5u = 10$
 $1u = 2$
 $9u = 2 \times 9 = 18$
 Now $\rightarrow 18 + 10 = 28 //$

Q3)

K	160s
R	115s 75s
H	105s 70s

$R \rightarrow 160 - 115 = 115$
 $H \rightarrow 115 - 10 = 105$
 $105s = 1 \text{ min } 45s //$

Q4)

W	$3n+4$	} 128
K	$3n+4$ $4n$	

$W + K = (3n+4) + (3n+4+4n)$
 $= 10n + 8$
 $128 = 10n + 8$
 $120 = 10n$
 $1n = 12 //$

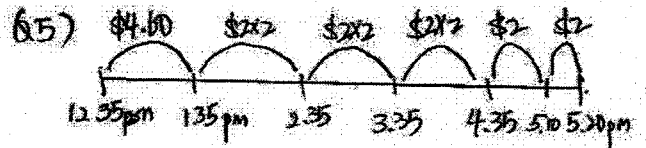

Total paid = $\$4.60 \times \4×4
 $= \$20.60 //$

Q6)

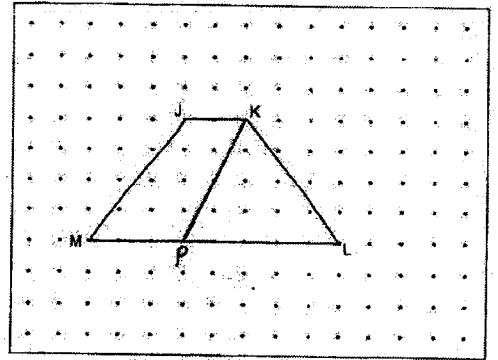

Q7) Total = $75 + 115 + 60 + 120$
 $= 370$

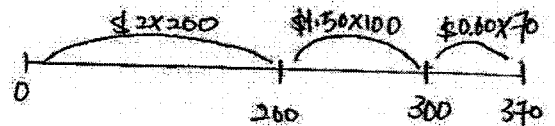

Total paid = $\$2 \times 200 + \1.50×100
 $+ \$0.60 \times 70$
 $= \$400 + \$150 + \$42$
 $= \$592 //$

Q8) $\frac{A:C}{5:3}$ Cost: $\frac{A:C}{\$45:\$23}$

$5 \times \$45 = \225
 $3 \times \$23 = \69
 1 group $(5A+3C) = \$225 + \69
 $= \$294$
 No. of groups $\rightarrow \$5292 \div \294
 $= 18$
 Total No. of adults = $18 \times 5 = 90 //$

Q9)

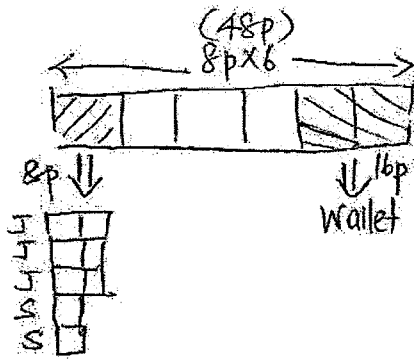

$$\begin{aligned}
 16p - 2p &= \$23.80 \\
 14p &= \$23.80 \\
 1p &= \$1.70 \\
 48p &= \$1.70 \times 48 = \$81.60 //
 \end{aligned}$$

Q10) (a) Jan = $8u$

$$\text{Feb} = 12u$$

$$\text{Increase} \rightarrow 12u - 8u = 4u$$

$$\% \text{ increase} \rightarrow \frac{4u}{8u} \times 100\% = 50\% //$$

(b) Ave = 45

$$\text{Total} = 45 \times 4 = 180$$

Total unit Jan to Apr

$$= 8u + 12u + 22u + 18u$$

$$= 60u$$

$$60u = 180$$

$$1u = 3$$

$$18u = 3 \times 18 = 54 //$$

$$\text{Q11) (a) } \angle RCS = \frac{180^\circ - 82^\circ}{2} = 49^\circ$$

$$\angle SCD = 90^\circ - 49^\circ = 41^\circ$$

$$\angle SDC = 41^\circ$$

$$\angle PDS = 90^\circ - 41^\circ = 49^\circ$$

$$\angle BSD = 180^\circ - 49^\circ = 131^\circ //$$

$$\text{(b) } \angle DPQ = 131^\circ$$

$$\angle APQ = 180^\circ - 131^\circ = 49^\circ$$

$$\angle AQP = 180^\circ - 90^\circ - 49^\circ = 41^\circ //$$

Q12)

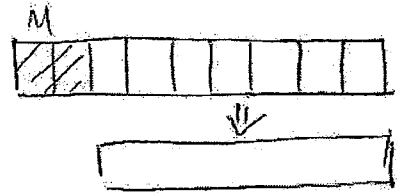

$$\frac{2}{9} = \frac{10}{45}$$

$$\text{Remainder} = 1 - \frac{10}{45} = \frac{35}{45}$$

$$\text{Sis} \rightarrow \frac{1}{5} \times \frac{35}{45} = \frac{7}{45}$$

$$\begin{aligned}
 M + S &= 10p + 7p + 22 \text{ beads} \\
 &= 17p + 22 \text{ beads}
 \end{aligned}$$

$$\text{left} = 45p - 17p - 22 \text{ beads}$$

$$34 \text{ beads} = 28p - 22 \text{ beads}$$

$$\begin{aligned}
 28p &= (34 + 22) \text{ beads} \\
 &= 56 \text{ beads}
 \end{aligned}$$

$$1p = 56 \div 28 = 2$$

$$45p = 2 \times 45 = 90 //$$

$$\text{Q13) (a) } 180 \text{ bottles} = (150 \times 180) \text{ cm}^3 = 27000 \text{ cm}^3$$

$$\begin{aligned}
 \text{Total water} &= 27000 \text{ cm}^3 + 5768 \text{ cm}^3 \\
 &= 27000 \text{ cm}^3 + 5768 \text{ cm}^3 \\
 &= 32768 \text{ cm}^3
 \end{aligned}$$

$$\begin{aligned}
 \text{One side} &= \sqrt[3]{32768} \\
 &= 32
 \end{aligned}$$

$$\text{Ans} : 32 \text{ cm} //$$

$$\text{(b) } 40 \text{ min} = 32768 \text{ cm}^3$$

$$\begin{aligned}
 1 \text{ min} &= 32768 \text{ cm}^3 \div 40 \\
 &= 819.2 \text{ cm}^3 //
 \end{aligned}$$

Q14) (a) $\angle DEG = 45^\circ$
 $\angle EKJ = 180^\circ - 45^\circ - 58^\circ$
 $= 77^\circ$

$\angle DKE = 180^\circ - 77^\circ$
 $= 103^\circ$
 //

(b) $\angle AFJ = 58^\circ$
 $\angle KAF = 77^\circ$
 $\angle BAC = 60^\circ$ (equilateral Δ)
 $\angle CGF = 180^\circ - 40^\circ - 90^\circ$
 $= 50^\circ$
 $\angle CAG = 180^\circ - 77^\circ - 60^\circ$
 $= 43^\circ$
 $\angle ACG = 180^\circ - 43^\circ - 50^\circ$
 $= 87^\circ$
 //

Q15)

M	10%	90%	\$72
C	60%	40%	

$\left. \begin{array}{l} \$72 \times 90\% = \$64.80 \text{ (spent)} \\ \$72 \times 10\% = \$7.20 \text{ (left)} \end{array} \right\}$

\Downarrow \$7.20

M	10%	5%	\$7.20
C	10%	5%	\$7.20

\leftarrow 14% \rightarrow
 \$7.20

$14 = 50\% - \$7.20$
 $14 = 10\% + \$7.20$

$\Rightarrow 50\% - \$7.20 = 10\% + \7.20
 $50\% - 10\% = \$7.20 + \7.20
 $40\% = \$14.40$
 $1\% = \$14.40 \div 40$
 $= \$0.36$
 $100\% = \$0.36 \times 100\%$
 $= \$36$

At first, M has $\rightarrow \$36 + \72
 $= \$108$
 //

Q16

a) 21, 31

b) shaded --- 22

unshaded --- $22+22+1 = 45$ total --- $22 + 45 = 76$

c) 39

Q17

Area of big circle = $\pi \times 36^2$
 $= 4069.44 \text{ cm}^2$

Area of 4 small circles = $4 \times \pi \times 15^2$
 $= 2826 \text{ cm}^2$

Diff. in area = $4069.44 - 2826$
 $= 1243.44 \text{ cm}^2$

Area of shaded star = square - circle
 $= 30 \times 30 - \pi \times 15^2$
 $= 193.5 \text{ cm}^2$

Area of A+B = $(1243.44 - 193.5) \div 4$
 $= 262.485 \text{ cm}^2$

Shaded area = star + $3 \times (\text{Area A+B})$
 $= 193.5 + 3(262.485)$
 $= 980.955 \text{ cm}^2$

