

RIVER VALLEY PRIMARY SCHOOL
2019 CONTINUAL ASSESSMENT 1 (CA1)
PRIMARY 6

STANDARD SCIENCE

(BOOKLET A)

Name : _____ ()

Date : 05/03/2019 (Tue)

Class : P6 _____

Time: 1 hour 45 min

INSTRUCTIONS TO CANDIDATES

1. Write your name, index number and class in the space above.
2. Do not turn over this page until you are told to do so.
3. Follow all instructions carefully.
4. Answer all questions.
5. For Section A, shade your answers for questions 1 to 28 on the Optical Answer Sheet (OAS).
6. For Section B, write your answers for questions 29 to 40 in the space provided.
7. The total marks for Booklet A is 56 marks.

Section A (56 marks)

For each question 1 to 28, four options are given. One of them is the correct answer. Make your choice (1, 2, 3 or 4). Shade the oval (1, 2, 3 or 4) on the Optical Answer Sheet.

1. The chart below shows the process of fertilisation when A from Part X fuses with B from Part Y in the human reproductive system.

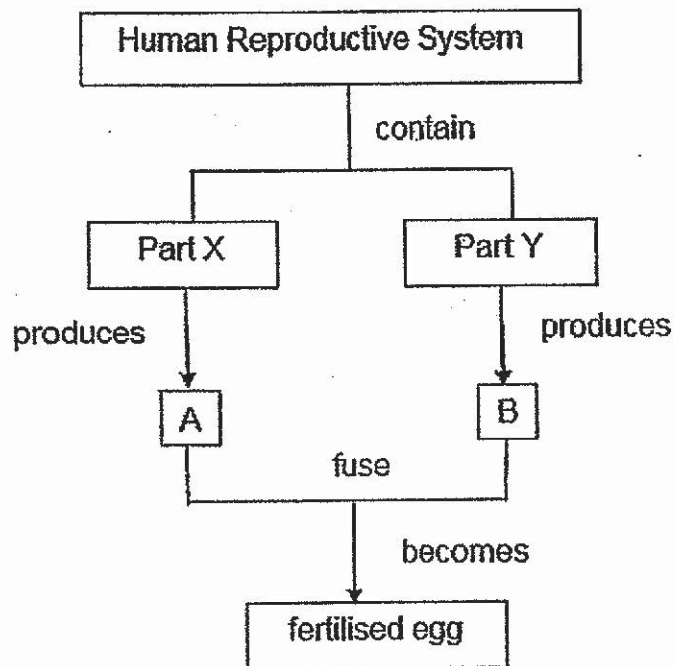

Which of the following shows correctly A, B, Parts X and Y?

	Part X	Part Y	A	B
(1)	womb	testis	egg	sperm
(2)	penis	womb	sperm	egg
(3)	ovary	testis	egg	sperm
(4)	testis	ovary	egg	sperm

()

2. The diagrams below show two single-celled organisms, X and Y, found in water.

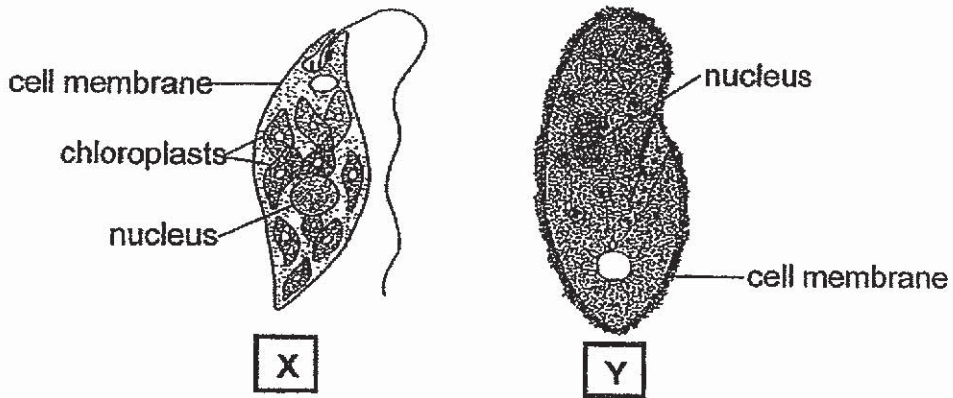

Based on the diagrams above, which of the following best shows where organisms X and Y could be found?

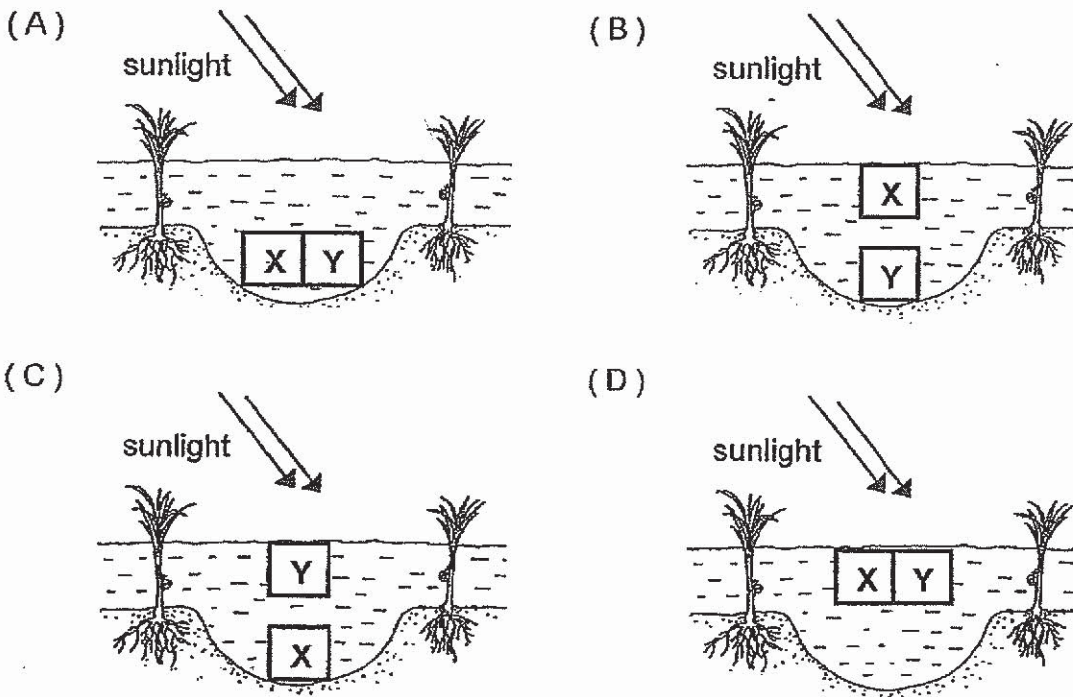

- (1) A and D only
- (2) B and C only
- (3) A and C only
- (4) B and D only

()

3. The diagram below shows Fruit S and cut slices of Fruit S.

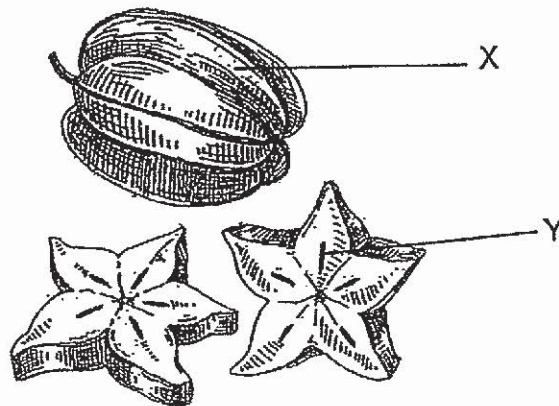

Which parts of the flower do X and Y develop from?

	X	Y
(1)	stigma	ovule
(2)	ovule	ovary
(3)	ovary	ovule
(4)	anther	stigma

()

4. The table below shows the characteristics of two plants, A and B.

Plant	Characteristics	
	dispersed by wind	reproduce by seeds
A	✓	✓
B	✓	

From the information given above, identify the groups that plants A and B belong to as shown in the classification chart below.

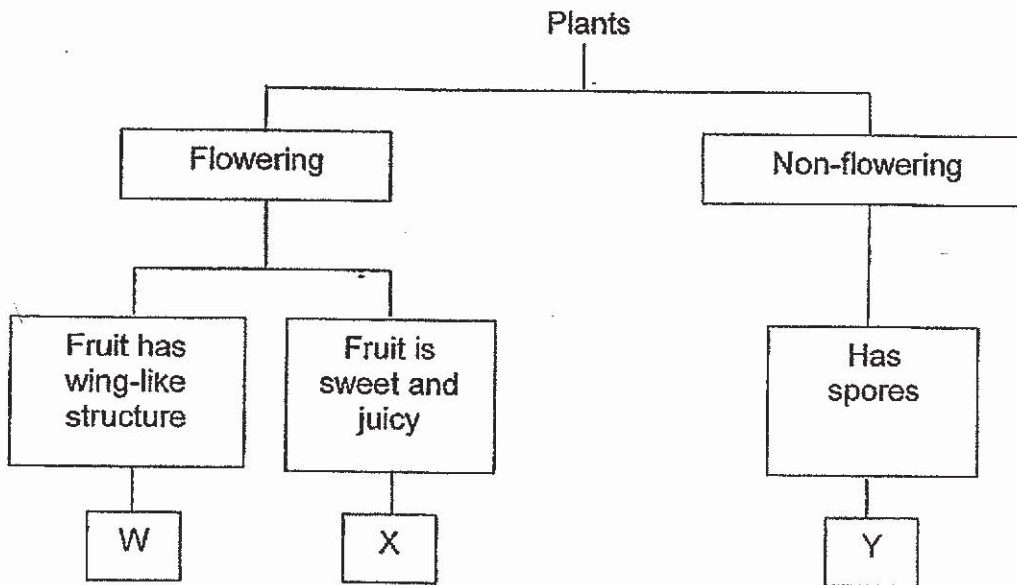

	Plant A	Plant B
(1)	W	Y
(2)	W	X
(3)	Y	W
(4)	X	W

()

5. Jessica placed a slice of apple each into two identical jars. She sealed Jar X and left Jar Y open as shown in the diagram below. Both jars were left on her kitchen table for seven days.

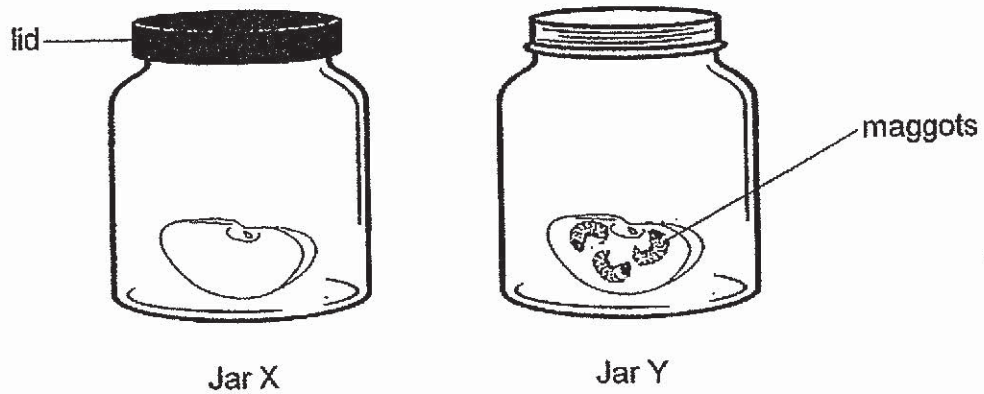

After seven days, Jessica observed that there were maggots, which are the young of fruit flies, in Jar Y, but not in Jar X. Based on her observation, what can she conclude?

- A: Jar Y allowed air to enter to keep the maggots alive.
- B: The apple slice produced the maggots.
- C: The fruit flies depend on the apple for food.

- (1) A and B only
- (2) A and C only
- (3) C and B only
- (4) A, B and C

()

6. Alice conducted an experiment using three different types of healthy seeds, E, F and G. She placed each seed E, F and G in identical cups as shown below. She placed all the cups next to a window. She watered the seeds with the same amount of water.

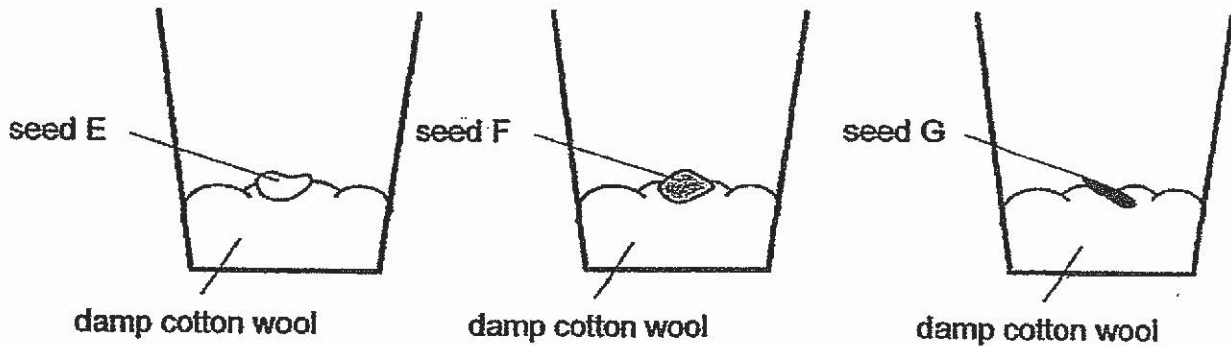

Alice observed the seeds for 15 days. She recorded the number of days taken for the roots of each seed to appear.

Seed	Number of days taken for the roots to appear
E	12
F	No roots appeared
G	7

Which of the following could Alice conclude?

- A: Seed F needed more sunlight to germinate.
- B: Seed G took the shortest time to germinate.
- C: Only seeds E and G needed warmth to germinate.
- D: Seed G would likely be the first to develop leaves for photosynthesis.

- (1) A and B only
- (2) B and D only
- (3) C and D only
- (4) A and C only

()

7. The diagram below shows the human circulatory system.

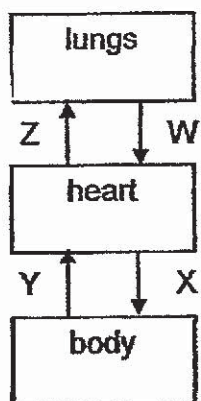

Circulatory system

Which of the paths contain more carbon dioxide and waste products?

- (1) W and X only
- (2) X and Y only
- (3) Y and Z only
- (4) W and Z only

()

8. A group of tourists were trapped in a cave as shown below.

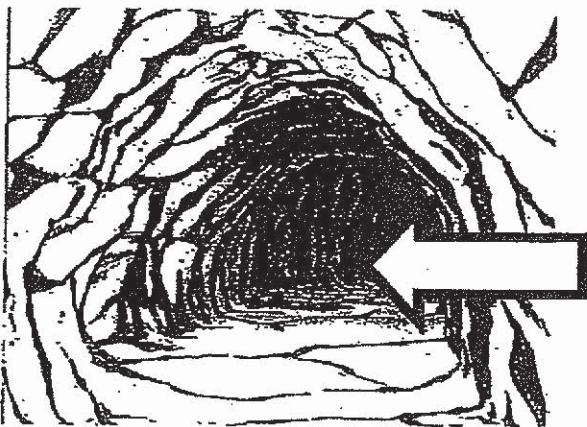

cave

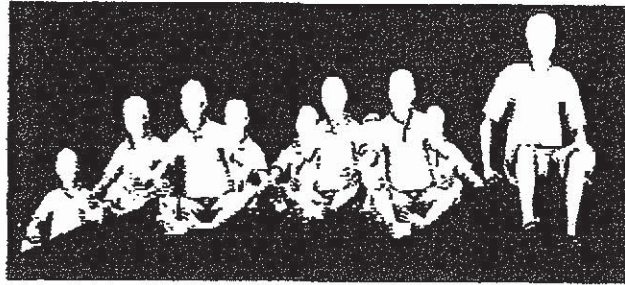

tourists trapped in a cave

How would the gases in the air change after some time?

- A: The amount of oxygen increased.
- B: The amount of nitrogen increased.
- C: The amount of water vapour increased.
- D: The amount of carbon dioxide increased.

- (1) A and B only
- (2) B and D only
- (3) C and D only
- (4) A and C only

()

9. Craig is a diver. After being underwater for some time, he felt a shortness of breath.

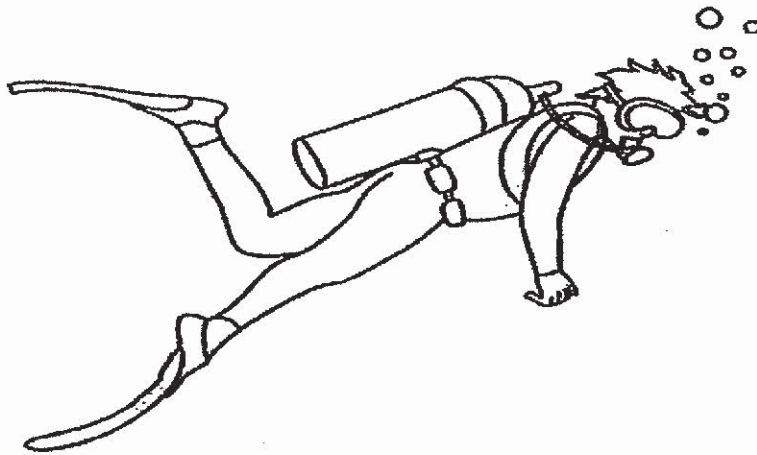

Which of his body's human systems are affected?

- A: Respiratory system
- B: Digestive system
- C: Circulatory system
- D: Reproductive system

- (1) A and B only
- () B and D only
- () C and D only
- () A and C only

()

10. The diagram below shows Part A to Part D of the human digestive system and the path which food will take as it enters the human body at Part A.

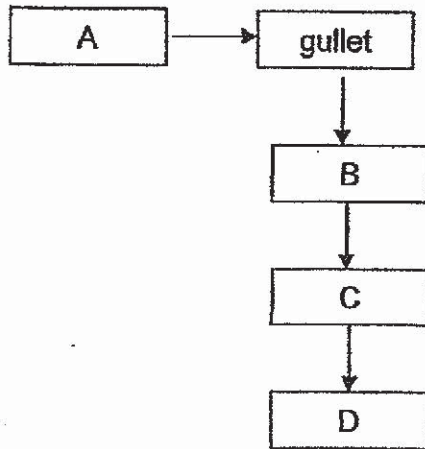

Which one of the following is correct?

	Parts ___ digest food.	Part ___ absorbs digested food.	Part ___ absorbs water.
(1)	A and C	B	C
(2)	A and D	B	C
(3)	A and B	C	D
(4)	A, B and C	C	D

()

11. Study the table below. Which one of the following sources of energy are **wrongly** classified?

	Potential Energy	Kinetic Energy
(1)	Petrol	Running water
(2)	The food we eat	A moving car
(3)	Ball rolling down a hill	Wind around us
(4)	A compressed spring	Waves in the sea

()

12. Bala released a ball at Point X as shown in the diagram below.

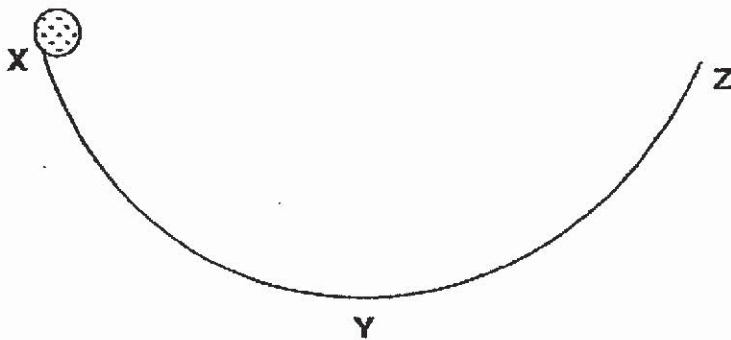

As the ball moved, its kinetic energy was calculated and plotted on the graph below.

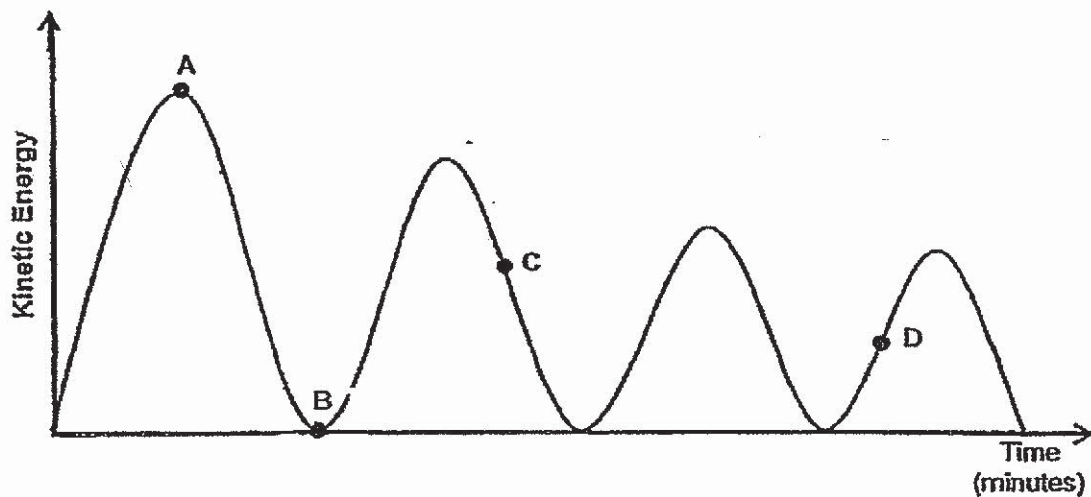

Which point on the graph represents the kinetic energy of the ball when it was at Y?

- (1) A
- (2) B
- (3) C
- (4) D

()

13. One form of energy can be changed to another. In the diagram below, different energy changes are marked by the arrows A, B, C and D. Which one of the following below shows the energy changes represented by arrows A, B, C and D?

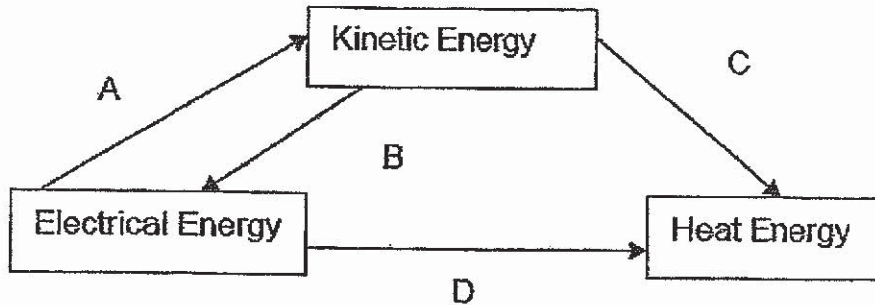

	A	B	C	D
(1)	A moving car	A turbine generating electricity	Waving your hands	A torchlight
(2)	A washing machine	A turbine generating electricity	Rubbing your hands together	An electric iron
(3)	A turbine generating electricity	An electric fan	An electric iron	A microwave oven
(4)	An aeroplane	A dynamo in a bicycle	Kicking a ball	An electric lamp

()

14. Which one of the following shows the correct sequence of energy changes when a battery-operated torch is switched on?

- (1) Electrical energy → Light energy + Heat energy
- (2) Potential energy → Electrical energy → Kinetic energy
- (3) Potential energy → Electrical energy → Kinetic energy → Light energy
- (4) Potential energy → Electrical energy → Light energy + Heat energy

()

15. Daniel took a shower using hot water and noticed that his bathroom mirror was clouded as shown in the diagram. He observed that Part P of the mirror was cloudy but Part Q of the mirror was clear.

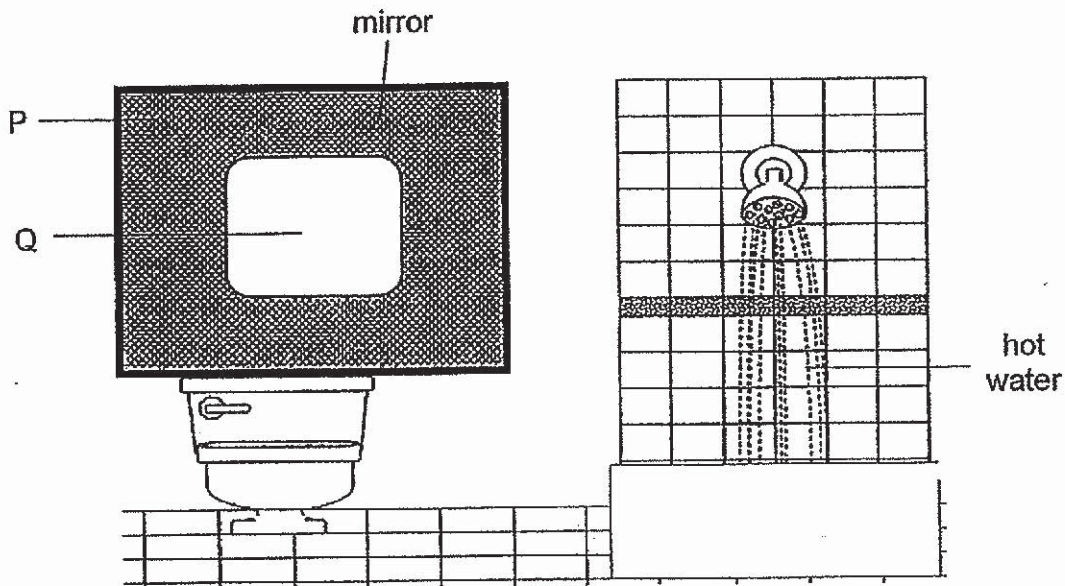

Which of the following statements is most likely true?

- A: Water vapour had condensed on P.
- B: P is warmer than Q during the shower.
- C: The clouds in P is made of water droplets.
- D: The temperature of Q is higher than that of P during the shower.

- (1) A and B only
- (2) A, C and D only
- (3) A, B and C only
- (4) A, B and D only

()

16. Two identical containers A and B were covered with identical lids. Container A was filled with 250g of ice cubes and Container B was filled with 250g of water at room temperature. They were placed on a balance as shown below.

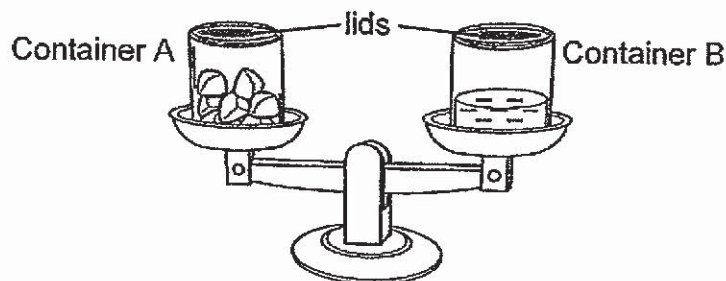

After ten minutes, the balance tilted downwards on the side of Container A.

Which of the following could be the reason?

- (1) The ice cubes in Container A melted.
- (2) The water in Container B had evaporated.
- (3) Water vapour condensed inside Container B.
- (4) Water vapour condensed on the outer surface of Container A.

()

17. The table below shows the melting points and boiling points of four substances, P, Q, R and S.

Substance	Melting Point (°C)	Boiling Point (°C)
P	0	100
Q	5	80
R	20	90
S	40	120

At which temperature(s) would all the substances be in the same state?

- A: 3°C
- B: 45°C
- C: 100°C
- D: 150°C

- (1) B only
- (2) A and C only
- (3) B and D only
- (4) A, C and D only

()

18. Sara was given four similar beakers, A, B, C and D. Each beaker was filled with different substances. She added water into each beaker at the same rate, one at a time. She measured the time taken for the water in each beaker to start to overflow.

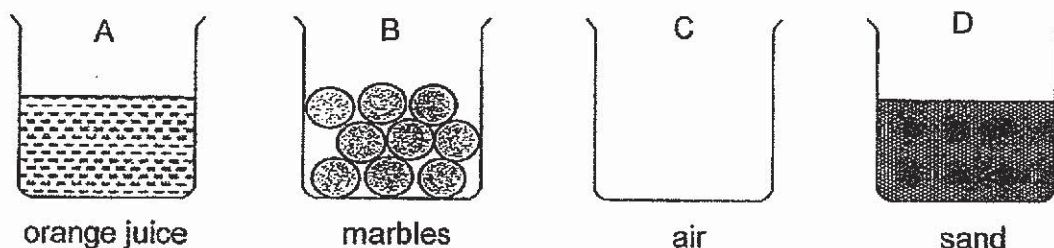

Which of the following shows the time taken for the water to overflow, from the first to overflow to the last?

- (1) A, C, B, D
- (2) A, B, D, C
- (3) B, C, A, D
- (4) B, D, A, C

()

19. Jack placed a solid made of substances Q, R and S in the set-up as shown below. Substances Q and R had higher melting points than substance S.

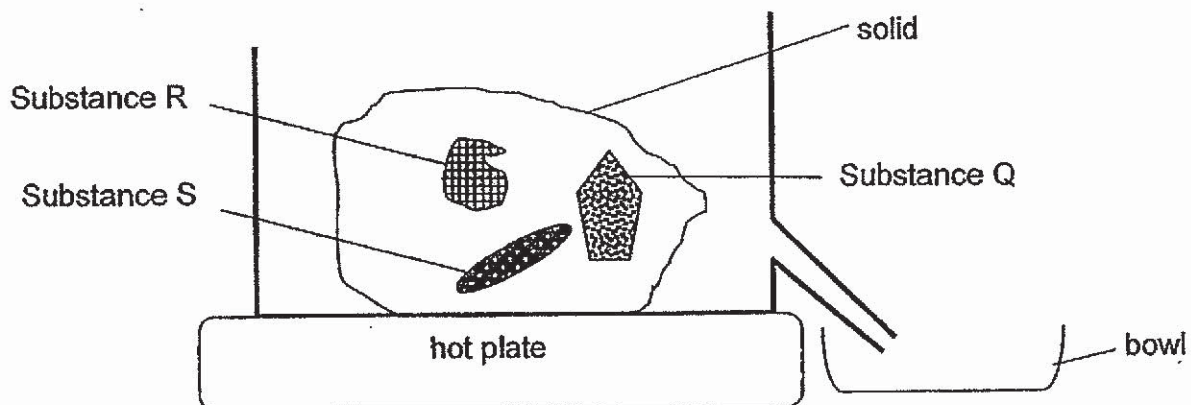

Before switching on the hot plate, he wanted to make sure that the liquid in the bowl contains only substance S. What temperature should he set for the hot plate?

- (1) Above the melting points of Q, R and S
- (2) Below the melting points of Q, R and S
- (3) Above the melting points of Q and R but below melting point of S
- (4) Above the melting point of S but below melting points of Q and R

()

20. Grace sets up an experiment as shown below. A steel cube and a ceramic cube both of the same volume were heated up to 85°C. They were immediately placed into Beaker A and Beaker B.

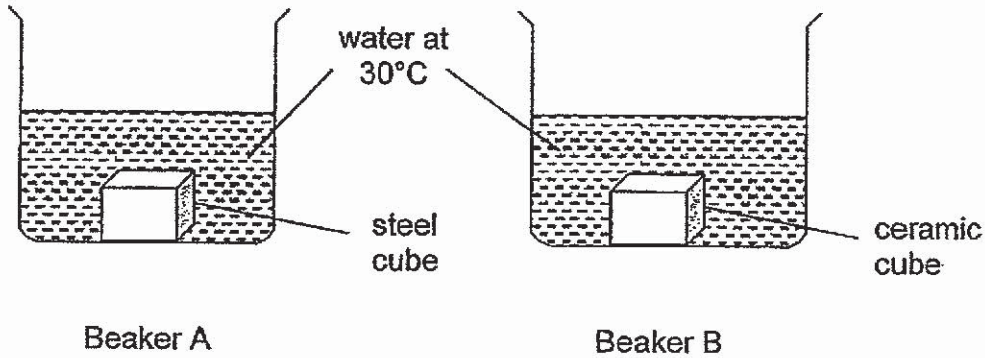

Which one of the following could be observed two minutes after the cubes were placed in the beakers?

	Temperature (°C)			
	water in Beaker A	water in Beaker B	steel cube	ceramic cube
(1)	30	30	85	85
(2)	50	60	70	80
(3)	60	50	85	85
(4)	60	50	70	80

()

21. Cheryl joined a piece of wood to a steel tube. She then wrapped a piece of paper tight around the centre of it. The paper was gently heated over at the centre as shown below.

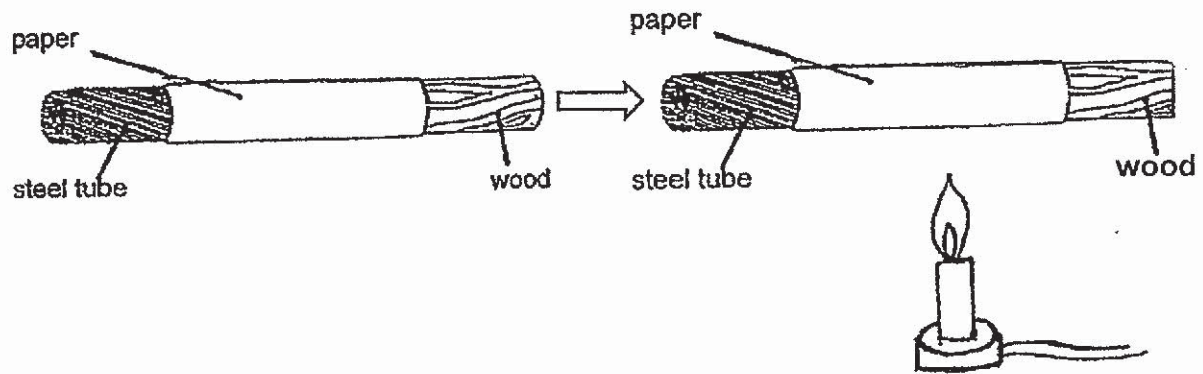

What will she observe after some time?

- (1) The paper around the wood is burnt as steel conducts heat better.
- (2) The paper around the wood is burnt as wood conducts heat better.
- (3) The paper around the steel tube is burnt as steel conducts heat better.
- (4) The paper around the steel tube is burnt as wood conducts heat better.

()

22. The following diagram shows the shadows of three identical sticks, A, B and C, placed at different positions in front of the screen.

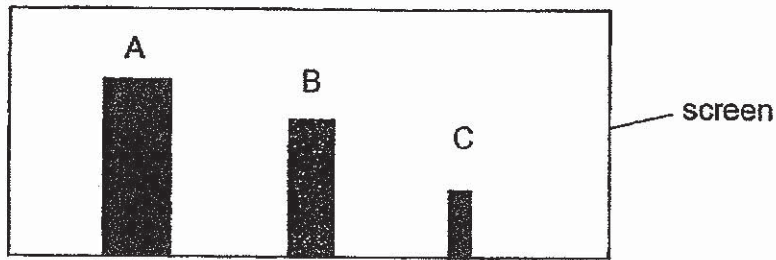

Which one of the following shows the correct positioning of the sticks?

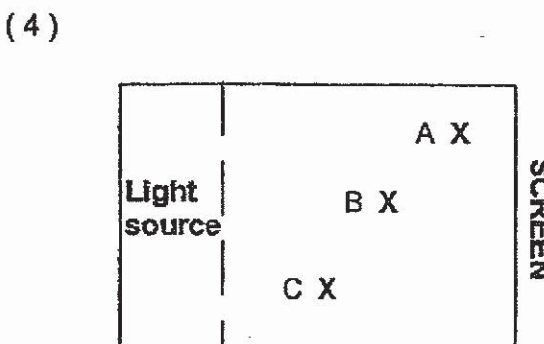
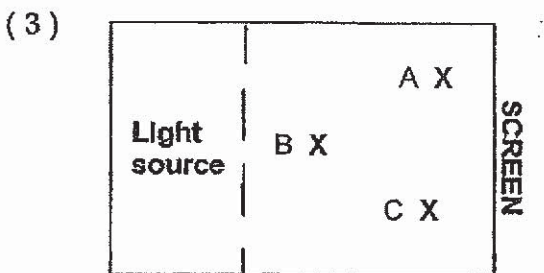
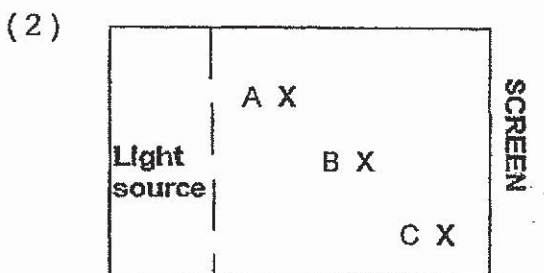
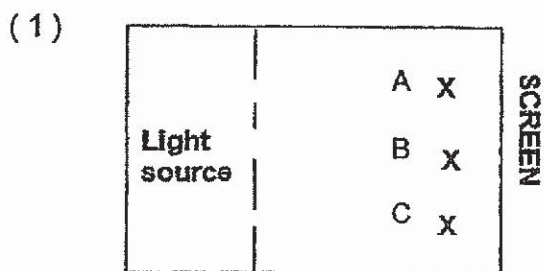

()

23. Kieran wanted to investigate the amount of light that can pass through three materials - clear plastic, tracing paper and cardboard. All the materials were of the same thickness. He used a light sensor to measure the amount of light that passed through. Which one of the following graphs best represents the result of the experiment?

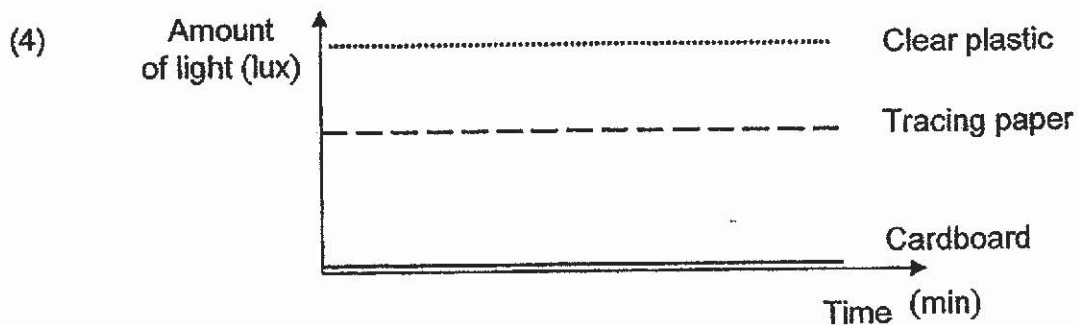
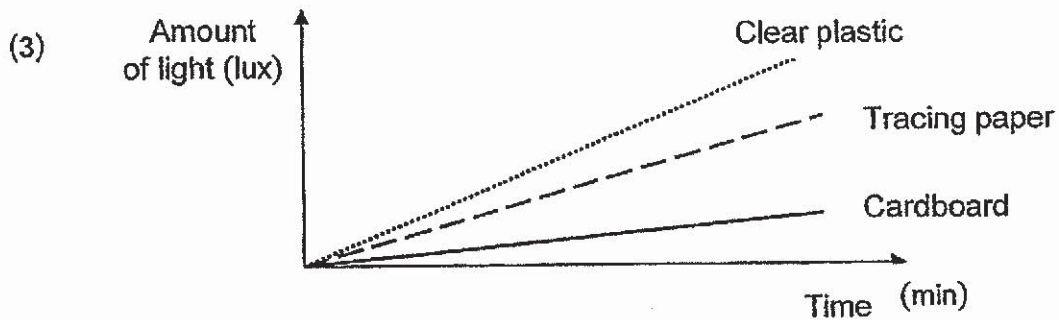
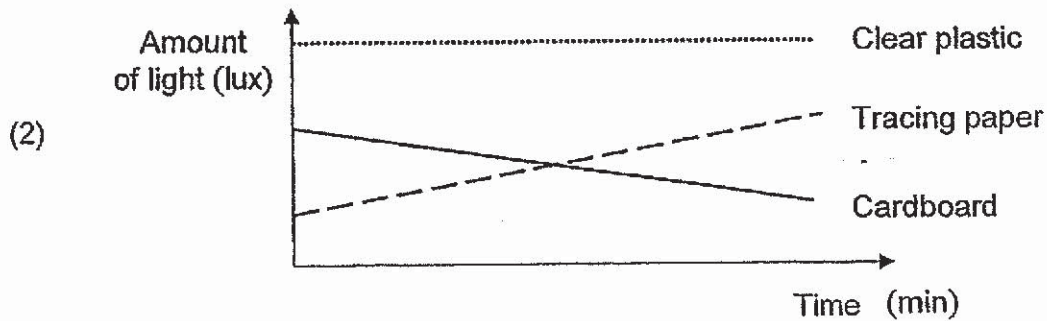
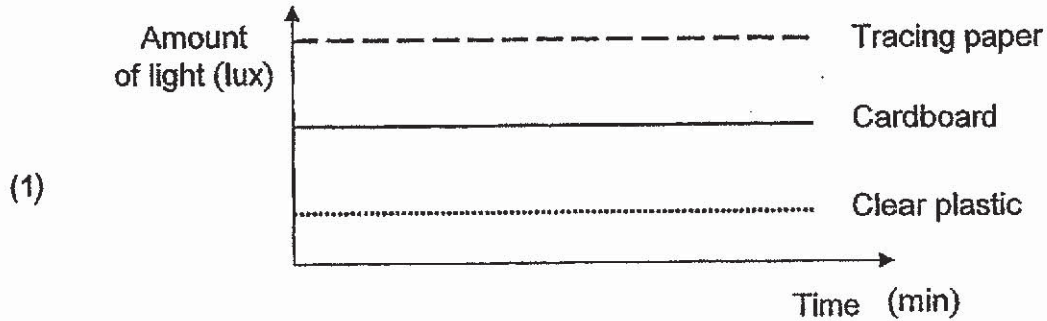

()

24. When two objects, A and B were placed on toy cars X and Y, the cars began to move towards each other. But when Object A is replaced by Object C, both toy cars did not move.

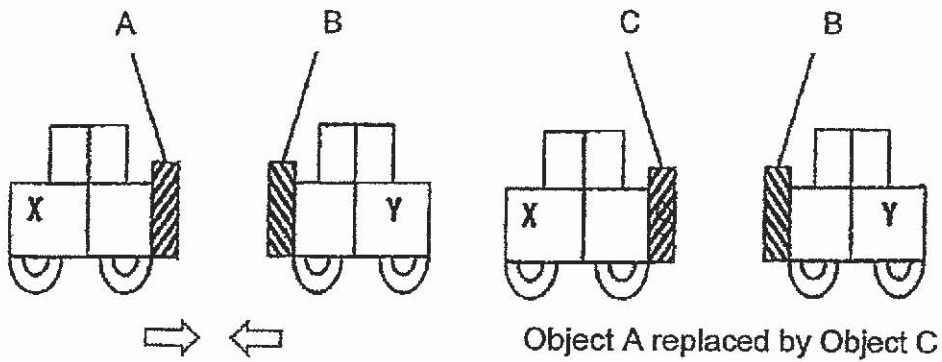

What could Objects A, B and C be?

	Object A	Object B	Object C
(1)	South pole of magnet	North pole of magnet	Plastic block
(2)	North pole of magnet	South pole of magnet	Steel block
(3)	Steel block	Plastic block	North pole of magnet
(4)	Plastic block	South pole of magnet	North pole of magnet

()

25. Ahmad set up the experiment to make a temporary magnet as shown below.

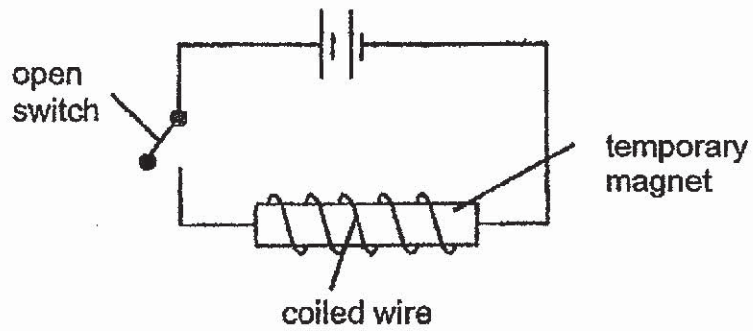

He brought a suspended rod near the temporary magnet. Which of the following diagrams is not a possible observation?

(1)

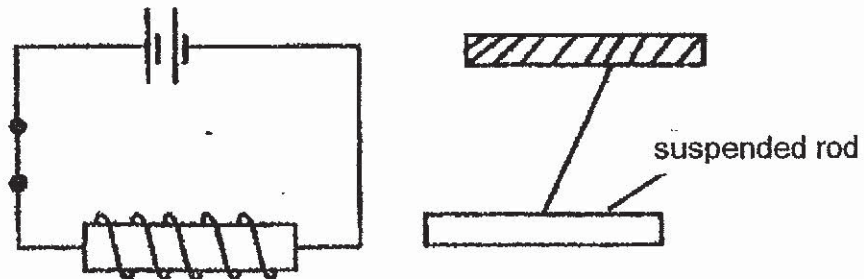

(2)

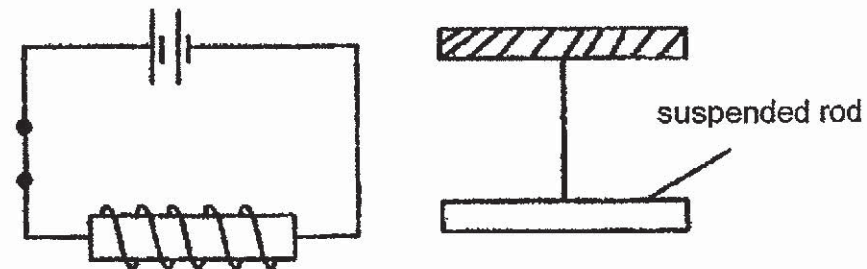

(3)

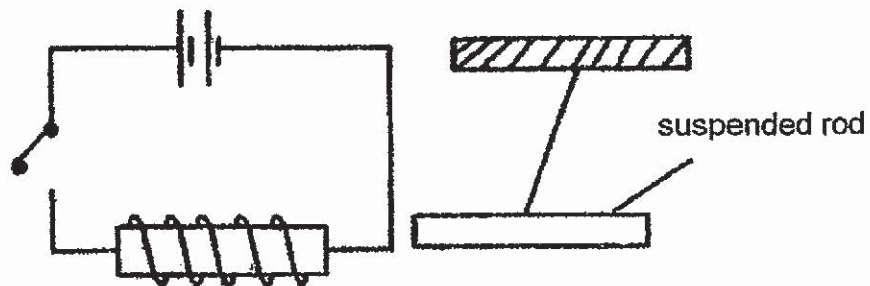

(4)

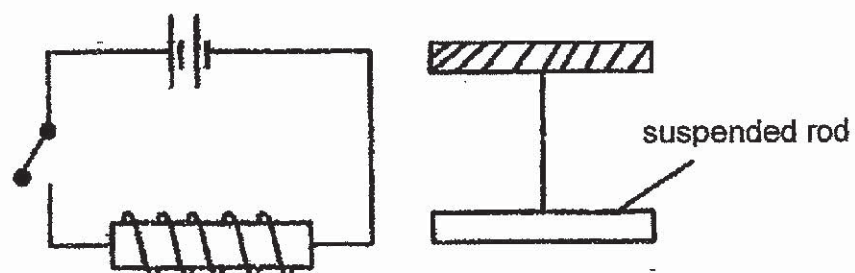

()

26. Study the circuit diagram below.

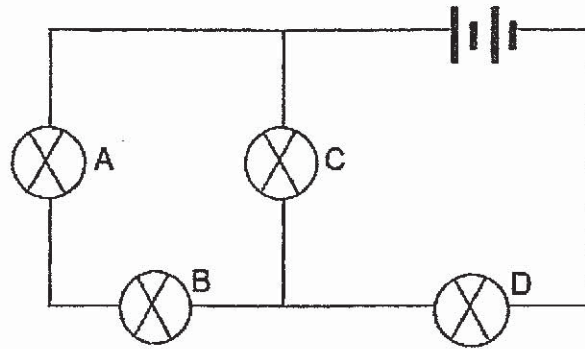

When one of the bulbs is not working, only two bulbs remain lighted.

Which bulb is not working?

- (1) A or B
- (2) B or C
- (3) C or D
- (4) A or D

()

27. Karen had three rods, P, Q and R, of unknown materials. She placed them in various positions, A, B and C, on the circuit shown below.

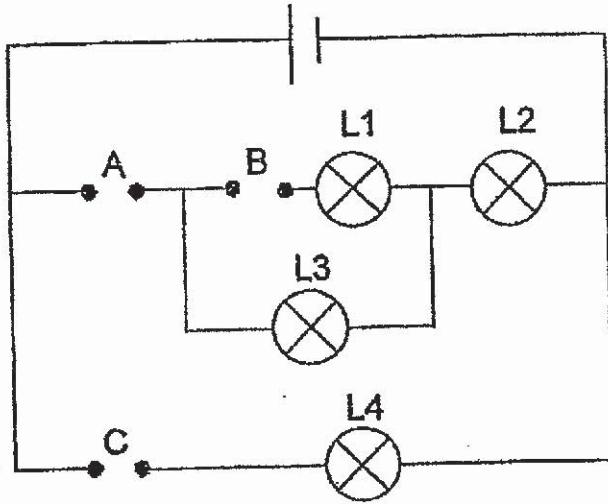

The results of the experiment were shown in the table below. When any of the lamps, L1, L2, L3 or L4, lit up during the experiment, a tick (✓) was placed in the box.

Experiment Results						
Positions where rods were placed			Lamp			
A	B	C	L1	L2	L3	L4
P	Q	R		✓	✓	✓

Which of the following would show the correct result if the rods, P, Q and R, were placed at different positions?

	Positions where rods were placed			Lamp			
	A	B	C	L1	L2	L3	L4
(1)	P	R	Q		✓	✓	✓
(2)	Q	R	P			✓	✓
(3)	R	Q	P	✓	✓	✓	
(4)	Q	P	R				✓

()

28. Jane hung three identical springs from the ceiling as shown below. Each spring was attached to an object of equal mass. Which of the following is not a possible observation Jane would make?

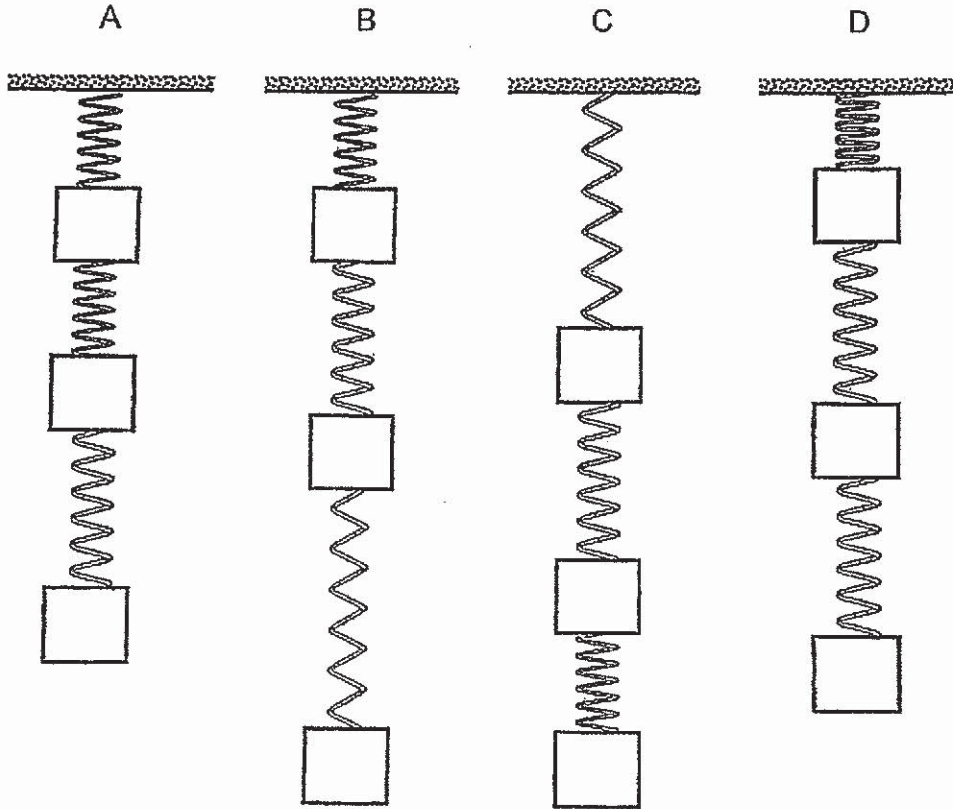

- (1) A and C
- (2) B and C
- (3) A, B and C
- (4) A, B and D

()

~ End of Booklet A ~

**RIVER VALLEY PRIMARY SCHOOL
2019 CONTINUAL ASSESSMENT 1 (CA1)
PRIMARY 6**

STANDARD SCIENCE

(BOOKLET B)

Name : _____ ()

Date : 05/03/2019 (Tue)

Class : P6 _____

Time : 1 hour 45 min

INSTRUCTIONS TO CANDIDATES

1. Write your name, index number and class in the space above.
2. Do not turn over this page until you are told to do so.
3. Follow all instructions carefully.
4. Answer all questions.
5. For Section A, shade your answers for questions 1 to 28 on the OAS.
6. For Section B, write your answers for questions 29 to 40 in the space provided.
7. The total marks for Booklet B is 44 marks.

Booklet A	56
Booklet B	44
Total	100

Parent's Signature: _____

Section B (44 marks)

Write your answers to questions 29 to 40 in this booklet.

29. The diagram below shows the different stages of the development of a plant.

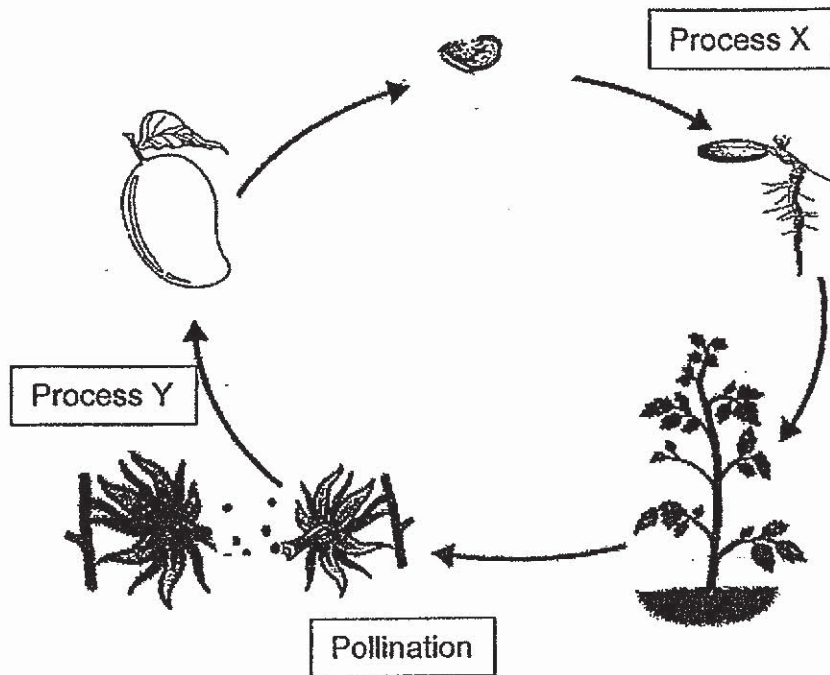

(a) Name the processes X and Y. [1m]

Process X: _____ Process Y: _____

(b) Explain how insects help in the development of the fruit in the plant. [1m]

(c) State one way insects benefit during the pollination process. [1m]

	3
--	---

30. During a field trip to a jungle, a group of scientists saw a flower as shown in the diagram.

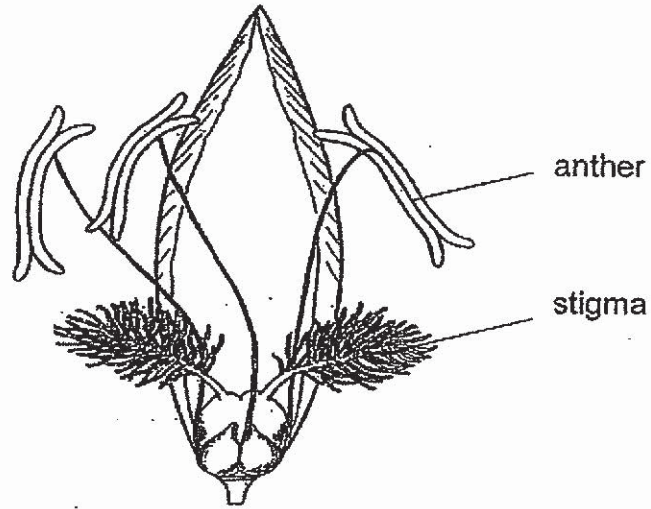

(a) Based on the diagram, give two reasons to explain why the flower is likely to be wind pollinated. [2m]

Reason 1:

Reason 2:

	2
--	---

The scientists found out that the flower develops into berries which are small fruits that contain many seeds. Birds eat these berries and pass out the seeds in their wastes. In this way, the birds help the plant to disperse its seeds.



(b) State two advantages in this method of dispersing seeds for the plant. [2m]

Advantage 1:

Advantage 2:

	2
--	---

31. The diagram below shows how blood flows in certain parts of the human body. W, X, Y and Z represent the blood vessels at different parts of the human body.

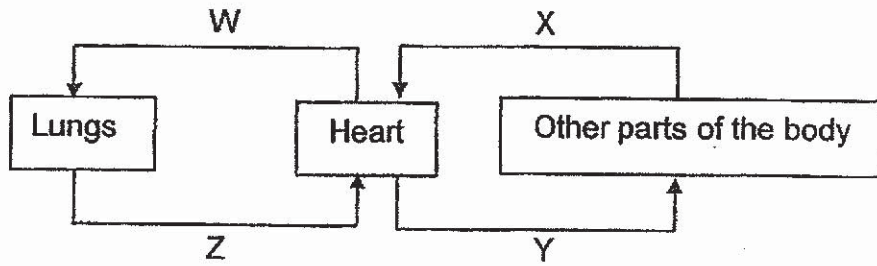

Based on the blood flow diagram above, Ray plotted a bar graph to show the difference in the amount of oxygen in the blood at W, X, Y and Z.

(a) Fill in each box below with the letters W, X and Y show the correct amount of oxygen in each blood vessel. [2m]

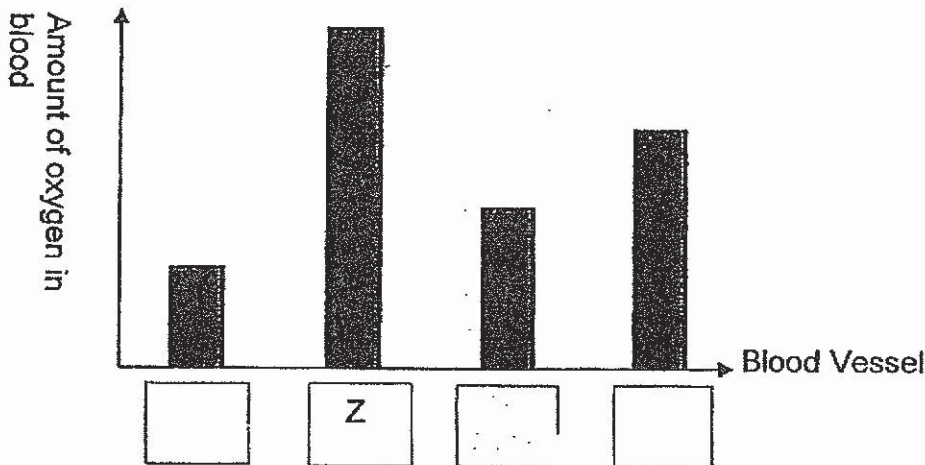

(b) A medical condition (where the heart stops working suddenly) have been on the rise. A person who experiences such a condition may lose consciousness easily. Based on the blood flow diagram above, explain why a person experiences such a condition. [2m]

	4
--	----------

32. A few students wanted to find out if temperature affects the rate of evaporation. They placed two similar containers of water in rooms P and Q. Both rooms are at different temperatures. They then recorded the volume of water and the results are shown below

Time (days)	Volume of water in each container (ml)	
	Room P	Room Q
0	100	100
1	84	92
2	68	84
3	52	78

(a) Which room is at a higher temperature? Explain your answer. [2m]

Unlike Singapore, deserts are much hotter. People who live in the desert perspire more but their clothes are still dry.

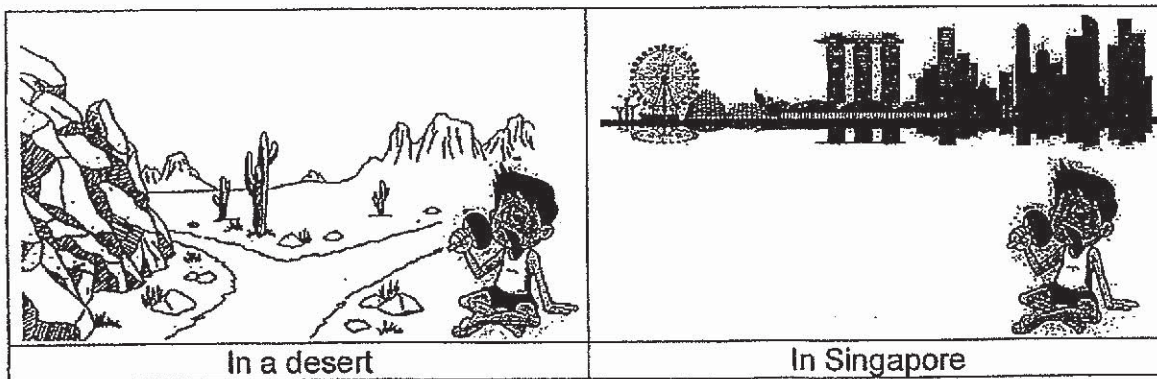

(b) Based on the experiment, explain why people in the desert will feel that their clothes are still dry, though they perspire more. [1m]

	3
--	---

At night, the temperature in the desert drops below 10°C. Water droplets can be seen on plants the next morning.

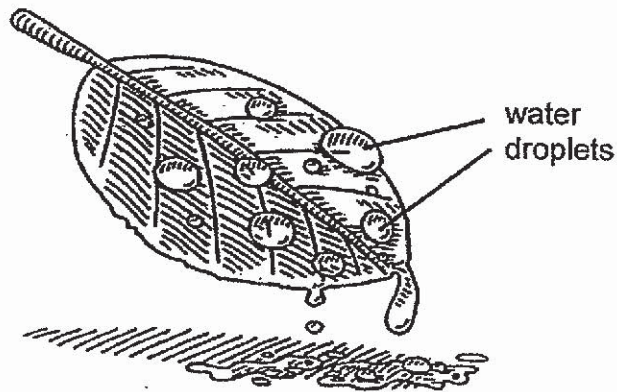

(c) Explain what causes water droplets to be seen on the plants the next morning. [1m]

	1
--	---

33. Jane set up the experiment below in a dark room.

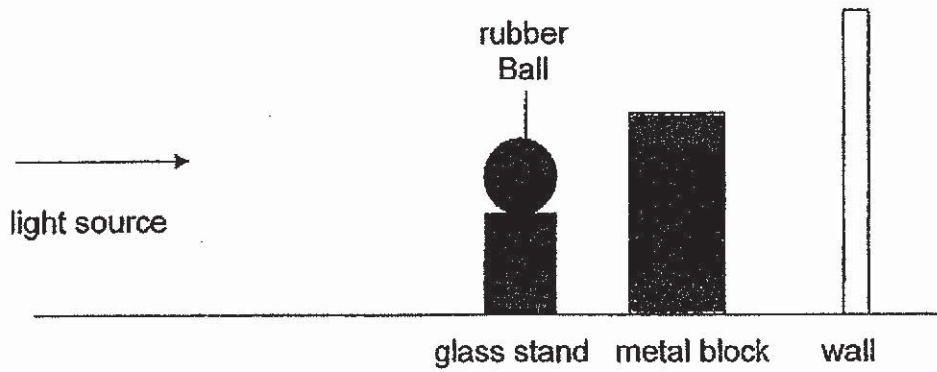

- (a) When Jane switched on the torch, she observed a dark shadow on the wall.
Draw the shadow observed on the wall. [1m]

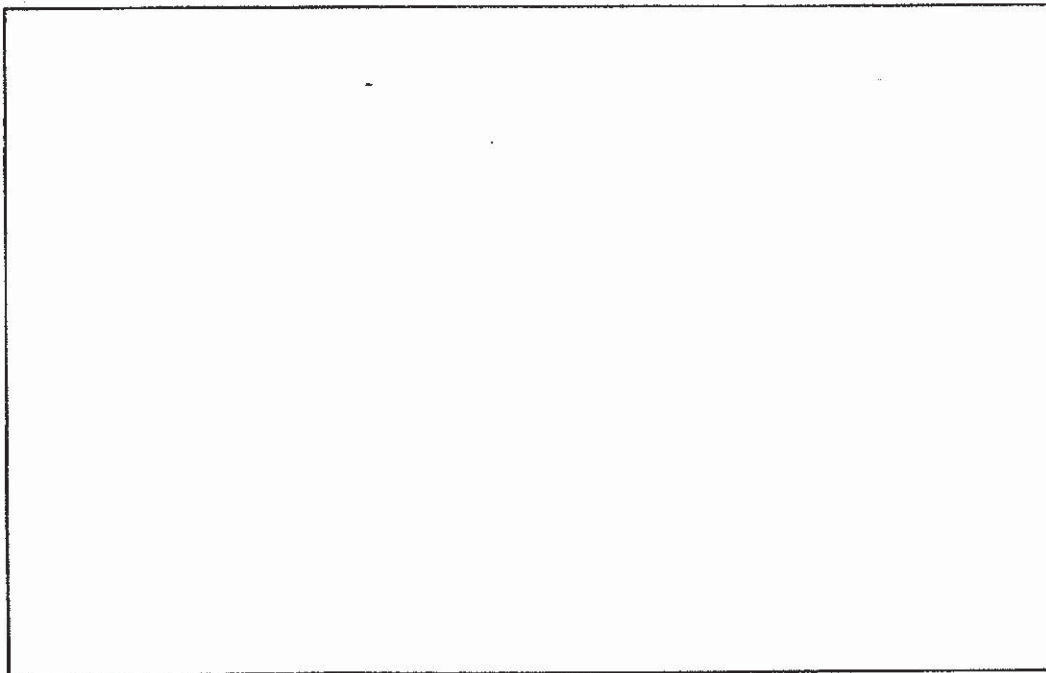

- (b) Without moving the wall, what must Jane do to make the shadow bigger? [1m]

	2
--	---

Jane wanted to find out how the distance between the torch and an object would affect the length of the shadow formed. In the experiment shown below, the angle at which the torch was shining at the wooden cone remained unchanged.

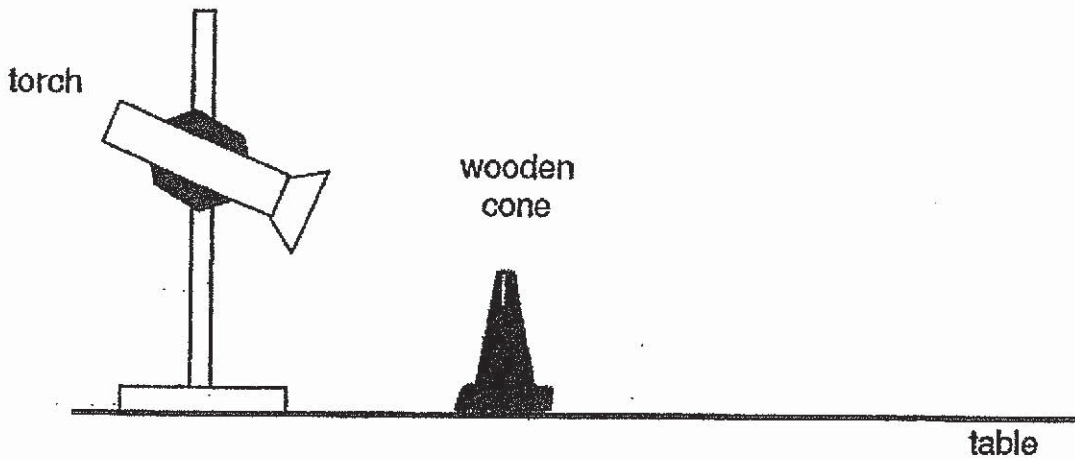

Jane measured the length of the shadow when the torch was placed at different distances from the wooden cone and recorded the results in the table below.

Distance of wooden cone from the torch (cm)	Length of shadow formed on the table (cm)
10	20
15	17
20	12
25	8

- (c) What is the relationship between the distance of the wooden cone from the torch and the length of shadow formed? [1m]

- (d) Jane used the same set-up and repeated the experiment with another object of the same size. She placed the object 20 cm away from the torch. This time no shadow was formed when the torch was switched on. Explain why this happened. [1m]

34. John plotted the graph below to show the time taken for a tennis ball to come to a stop when it was rolled over four different floor surfaces, E, F, G and H.

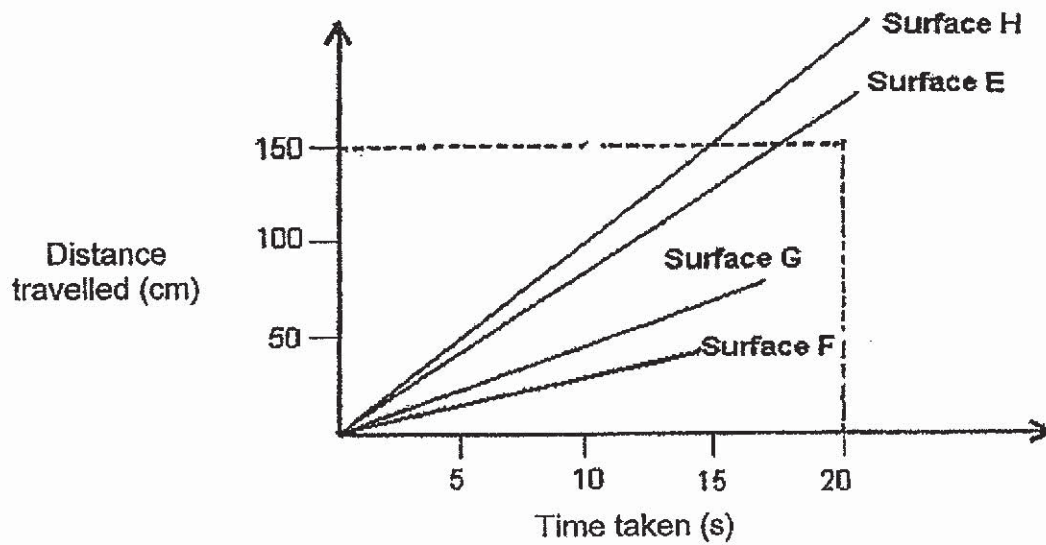

(a) Which surface, E, F, G and H, is the roughest? Give a reason for your answer. [1m]

(b) What can John conclude about the relationship between the surface of the floor and the amount of friction? [1m]

John dropped a tennis ball from a height and noticed that it bounced on the ground a few times. The height of the next bounce was lower than the height of the previous bounce.

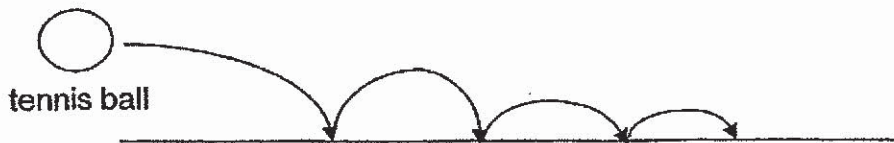

(c) Explain why the height reduced with each bounce. [1m]

	3
--	---

35. The diagram below shows a tower in an adventure camp. The students will start at the platforms and travel down the zipline to reach the ending point.

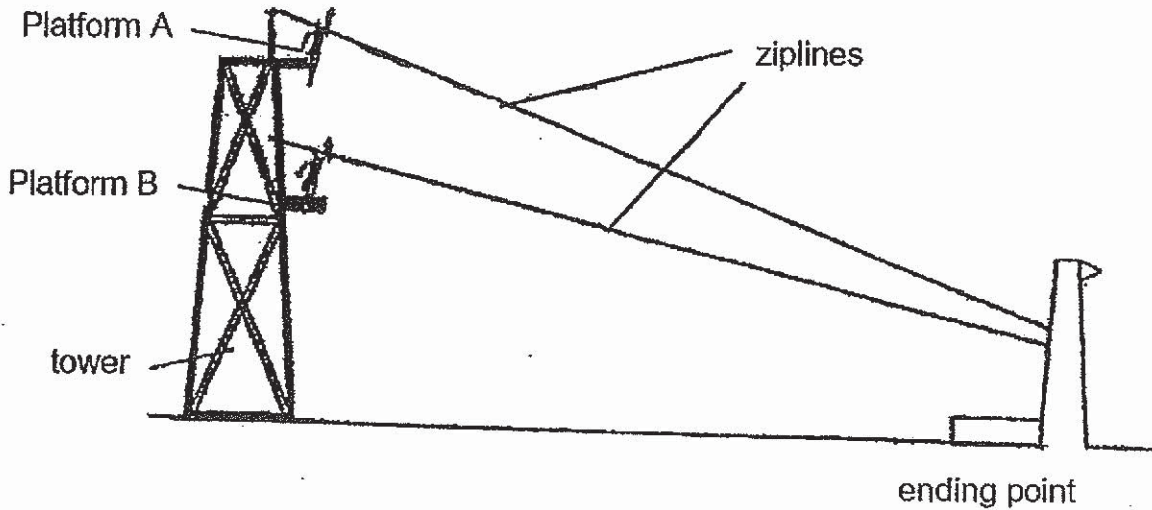





- (a) David is a thrill-seeker who wants to travel down to the ending point at a higher speed. Which platform, A or B, should he choose? Give a reason for your answer. [1m]

- (b) Name two forces acting on David as he is travelling down the zipline. [1m]

	2
--	---

David was told that falling objects of more mass have more potential energy.

(c) Using the materials given in the table below, help him plan a fair investigation to prove that the above statement is true. [2m]

Materials				
				
iron ball 50g	iron ball 100g	ruler	sand in a tray	

Step 1	
Step 2	
Step 3	
Step 4	

(d) If the statement that falling objects of more mass have more energy is true, what would David observe so that he could make the right conclusion? [1m]

36. Anna formed three new circuits X, Y and Z. She used a light sensor to measure the brightness of one of the bulbs in each circuit. The sensor gave the results on the bar graph below.

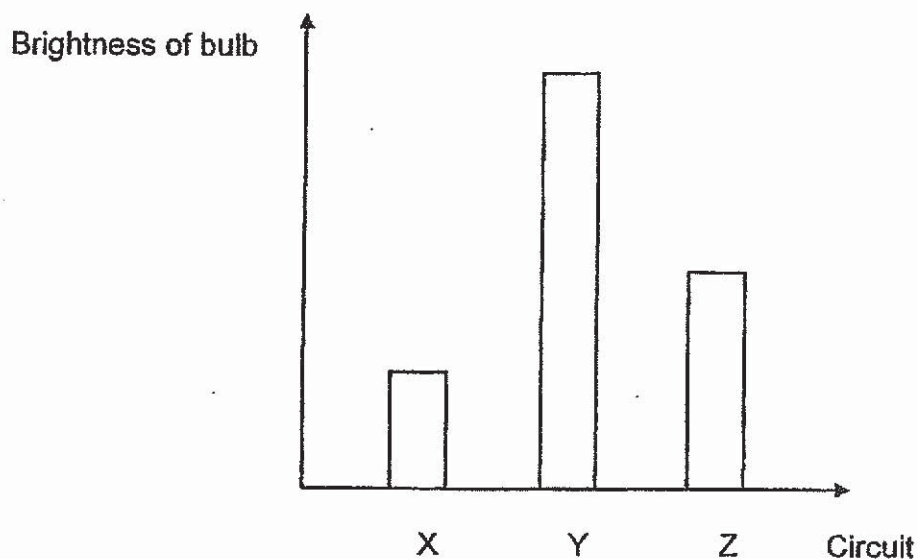

(a) The following table shows the three circuits. Observe them carefully and match the circuit to the corresponding letter in the bar graph. [1m]

Circuit	Letter

	1
--	----------

(b) Anna wanted to test the following materials, P, Q, R and S, to see if they conduct electricity.

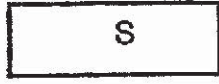
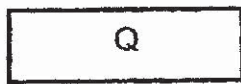
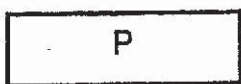

Using a bulb, a battery, a switch and some wires, draw a circuit diagram in the box below to show how Anna should test material P. [1m]



bulb



battery



switch



wires

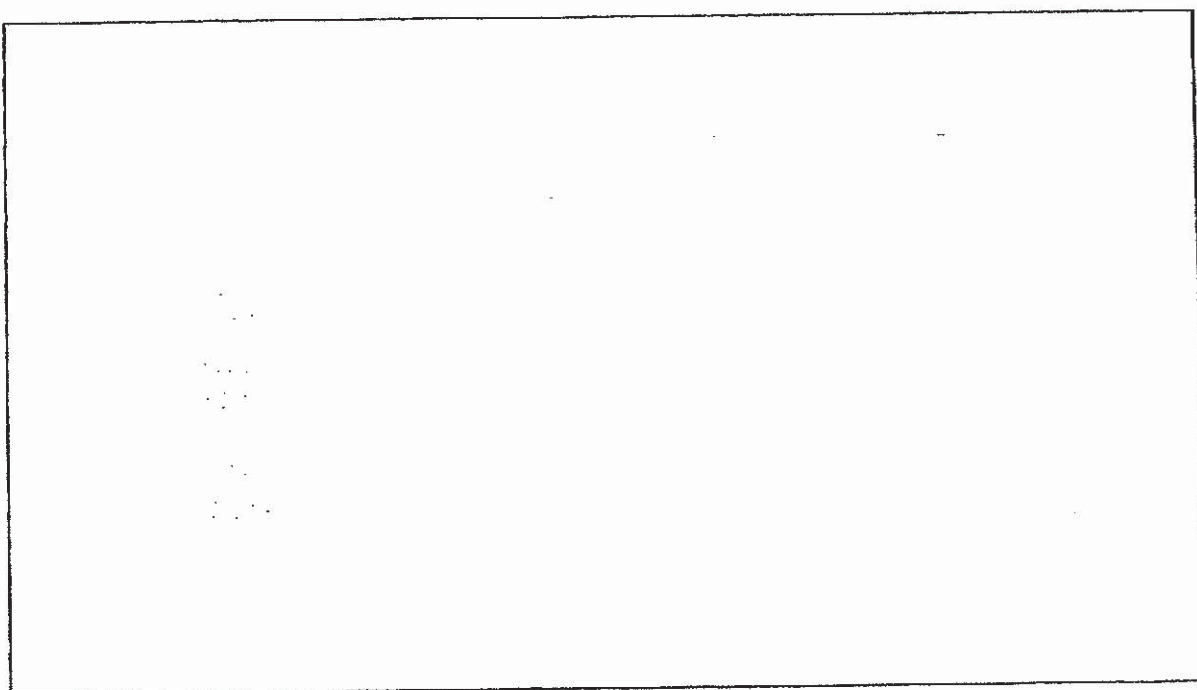

	1
--	---

As Anna tested the materials, she recorded the brightness of the bulb in the table below.

Materials	Brightness of Bulb
P	Bright
Q	Unlit
R	Very bright
S	Dim

Lightning rods are placed at the highest point and they channel lightning safely to the ground when lightning strikes. The Merlion statue was damaged when lightning struck. Anna suggested installing lightning rods on the statue.

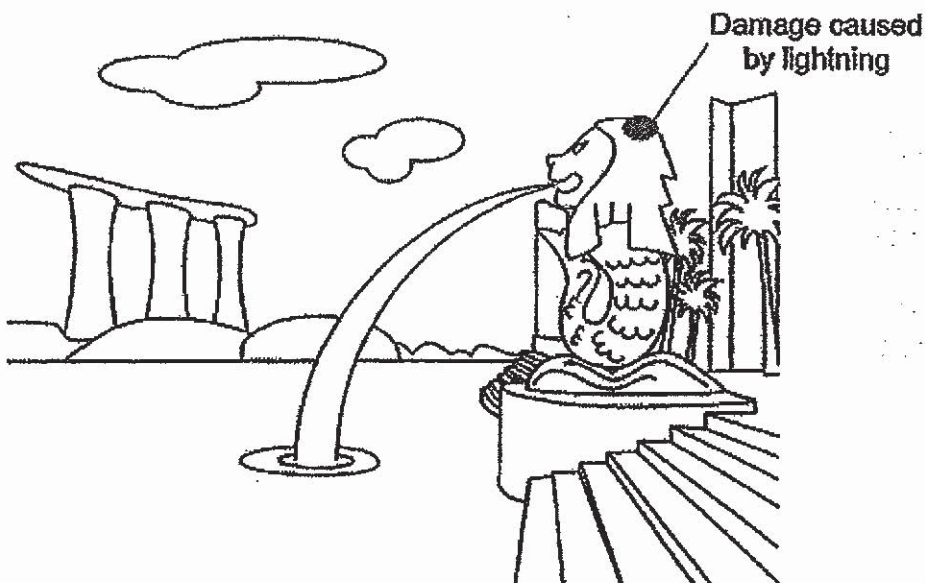

- (c) Which material P, Q, R or S is the most suitable to be used as a lightning rod?
Explain your answer. [2m]

37. The picture below shows a pile driver. The hammer is raised first before it is dropped to push the pile into the ground.

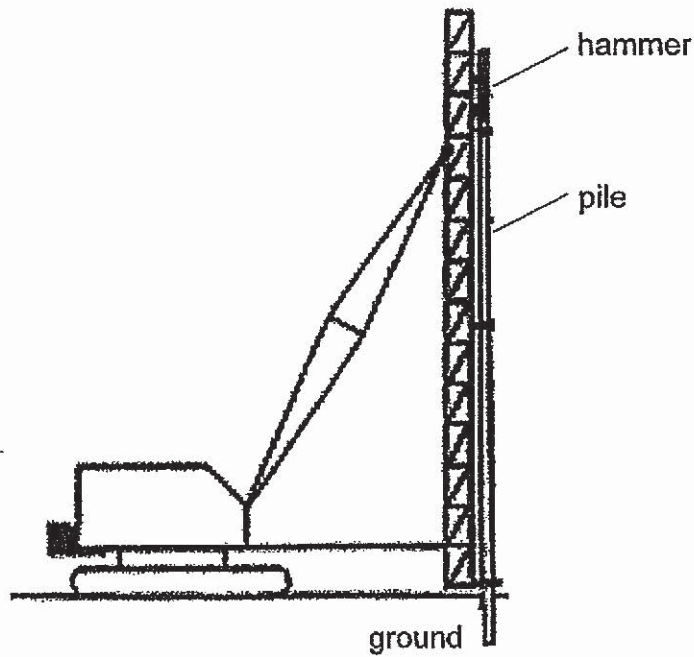

(a) Complete the energy conversion diagram below. [2m]

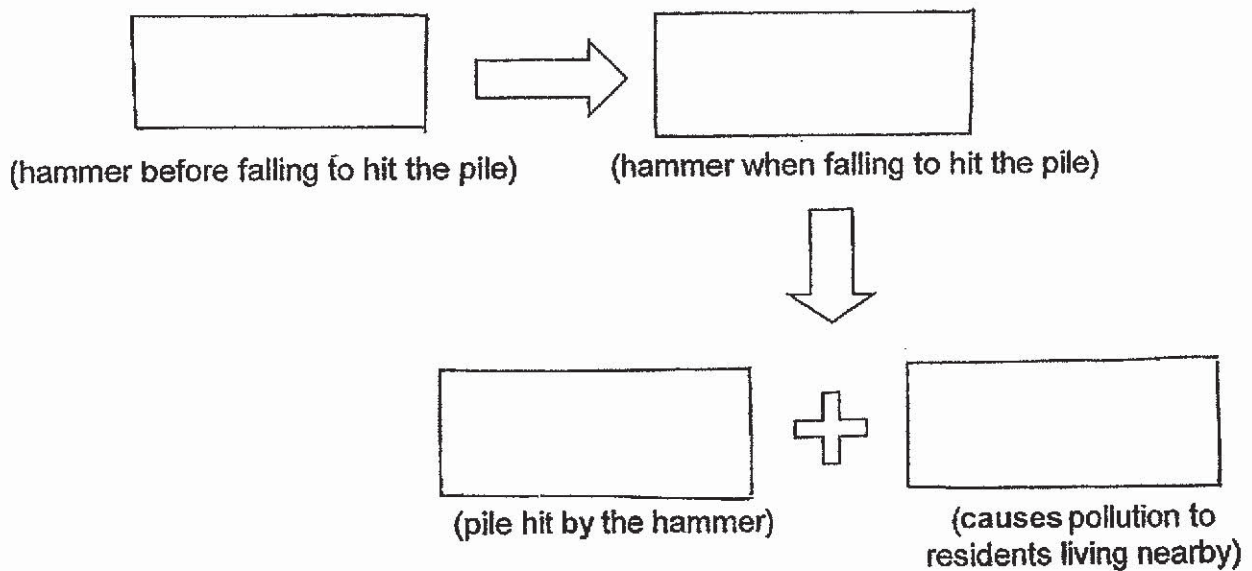

	2
--	----------

The picture below shows a mallet brought up to Position A before it is released to hit the ball on the ground.

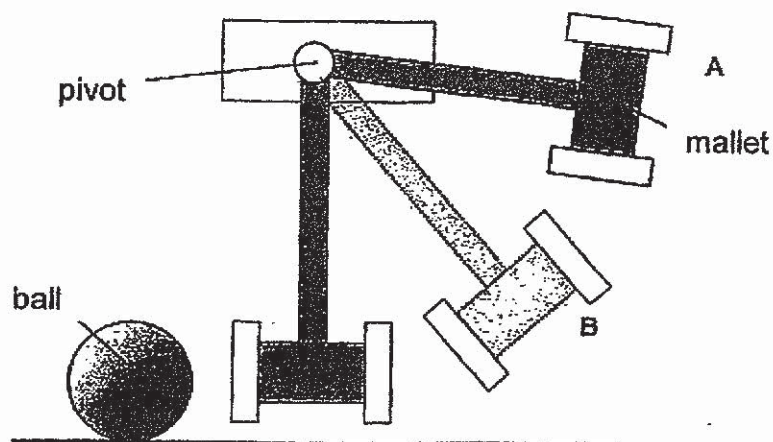

When the mallet is released at A or B, the ball gets energy from the mallet to move a certain distance. For the pile driver, when the hammer hits the pile, the pile also gets energy from the hammer and moves into the ground.

(b) Explain why the pile gets more energy from the hammer than the ball from the mallet. [1m]

	1
--	---

38. Jenny made a toy car as shown below.

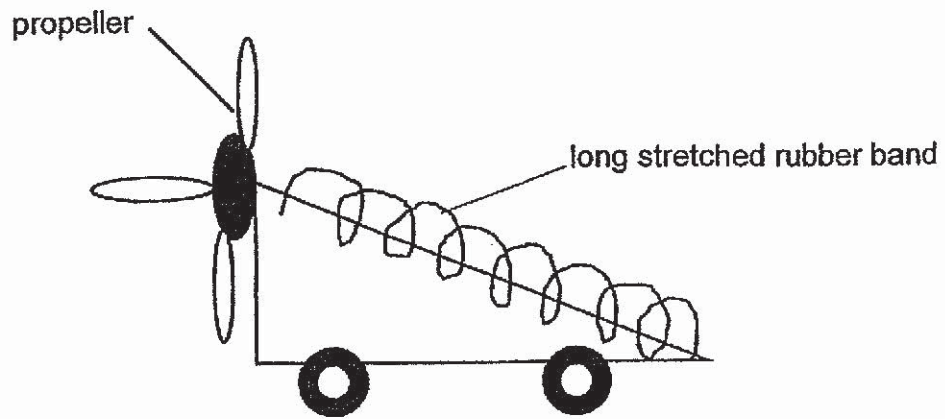

(a) Identify the energy the stretched rubber band possesses. [1m]

(b) State the energy conversion when the toy car is released and moved a distance. [1m]

(c) Without changing the set-up of the car, state two ways Jenny can make the toy car go further. [2m]

	4
--	---

39. Study Set-ups A and B as shown below carefully. In Set-up A, a plastic spoon is placed in the steel cup. In Set-up B, a steel spoon is placed in the plastic cup. The volume of water is the same in both cups. The table below shows the changes in temperature of the water over 15 minutes.

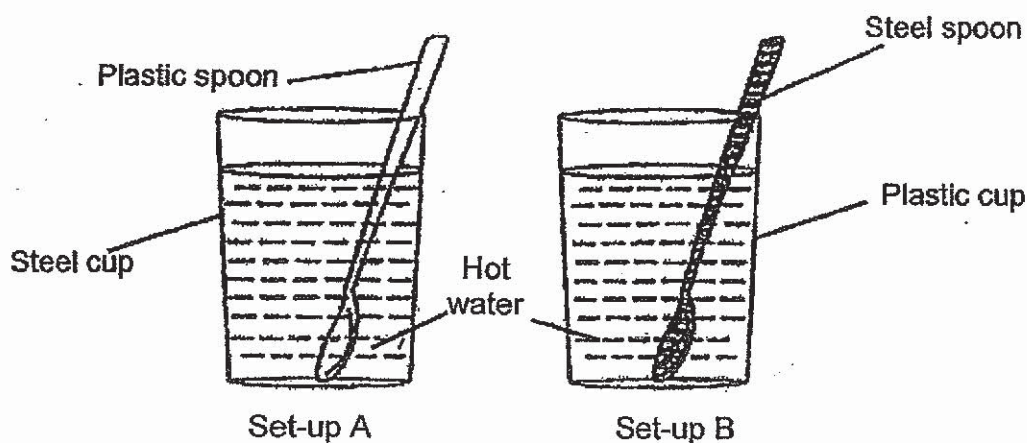

Set-up	Temperature of water (°C)			
	0 min	5 min	10 min	15 min
	70	58	49	41
	70	47	35	30

- (a) In the table above, complete the table by stating which set-up is 'A' or 'B'. [1m]
- (b) Explain your answer in (a). [2m]

	3
--	----------

40. Peter had two magnets, Magnet X and Magnet Y. To test if these two magnets could still be used, he brought both magnets near two paper clips and his observation was shown in the diagrams below.

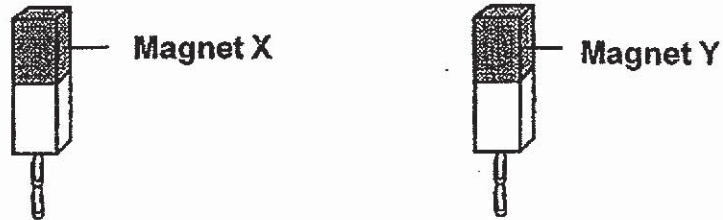

He then carried out the experiment below using six paper clips. The paper clips were attracted by Magnet X. When he repeated the same experiment with Magnet Y, the paper clips were not attracted.

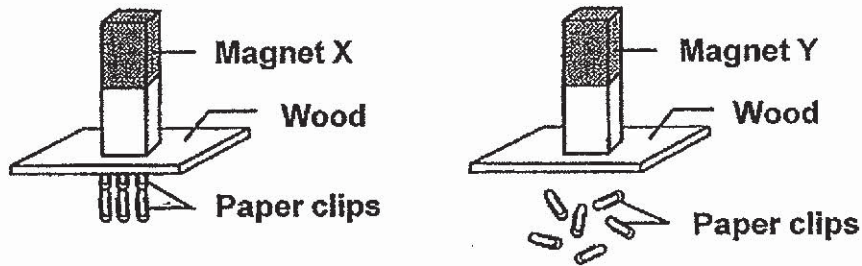

(a) Give one possible reason to explain why only Magnet X was able to attract the paper clips. [1m]

	1
--	---

Peter's father bought a "floating" globe as shown in the diagram below.

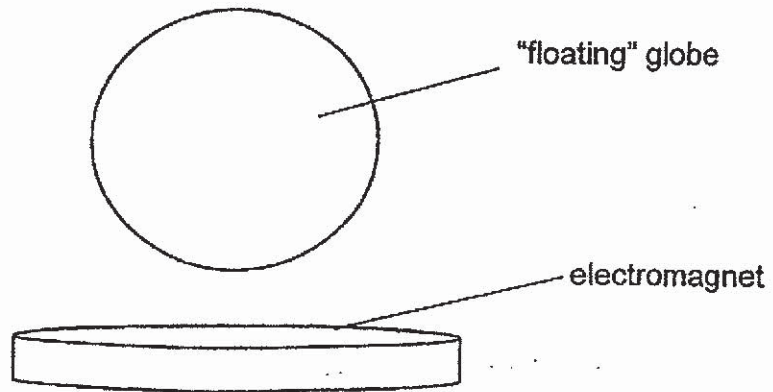

(b) Based on the above set-up, name the forces that are acting on the "floating" globe. [1m]

(c) Explain how the electromagnet allows the globe to "float" in the air. [1m]

	2
--	---

~ End of Paper ~

SCHOOL : RIVER VALLEY PRIMARY SCHOOL
 LEVEL : PRIMARY 6
 SUBJECT : SCIENCE
 TERM : 2019 CA1

SECTION A

Q 1	Q2	Q3	Q4	Q5	Q6	Q7	Q8	Q9	Q10
3	4	3	1	2	2	3	3	4	4
Q 11	Q12	Q13	Q14	Q15	Q16	Q17	Q18	Q19	Q20
3	1	2	4	2	4	3	2	3	1
Q 21	Q22	Q23	Q24	Q25	Q26	Q27	Q28		
4	2	4	3	3	1	4	1		

SECTION B

Q29)	<p>a)Process X: Germination Process Y : Fertilisation</p> <p>b)Insects carry pollen grains from the anther to the stigma of the flower and it helps in pollination the plant.</p> <p>c)Insects obtain nectar from the flower.</p>
Q30)	<p>a)Reason 1:The anthers and the stigmas are hanging outside of the flower, allowing the wind to carry/blow the pollen grains away easily.</p> <p>Reason 2 :The stigma is sticking out of the flowers, allowing it to catch the pollen grains carried by the wind easily.</p> <p>b)Advantage 1:The pollen grains are dispersed a further distance away from the position of the flower, reducing overcrowding.</p> <p>Advantage 2:Wastes/droppings provide nutrients for the young seedling.</p>
Q31)	<p>a)W Z X Y</p> <p>b)During a cardiac arrest, the heart is unable to pump oxygenated blood to all parts for the body.Thus,the brain does not get the</p>

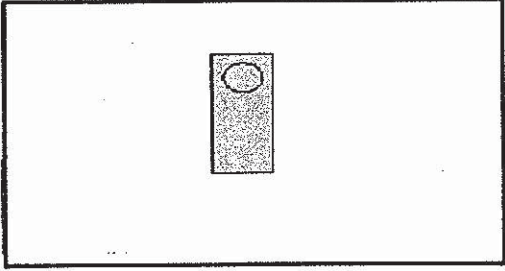
	oxygen it needs to function, causing the person to lose consciousness.
Q32)	<p>a) Room P. The volume of water in the container is the least. Hence, there is a higher temperatures and the water in the container gained heat and evaporates the most. Thus, room P is at a higher temperature.</p> <p>b) In areas of higher temperature, there is higher rate of evaporation.</p> <p>c) The warmer water vapour from the surroundings comes into contact with the cooler surface of the leaves, loses heat and condense to form water droplets on the leaves of the plants.</p>
Q33)	<p>a)</p> <div style="text-align: center;">  </div> <p>b) Move the light source nearer to the objects</p> <p>c) When the distance between the wooden cone from the torch increases, the length of shadow formed decreases.</p> <p>d) The object could be made of a transparent material.</p>
Q34)	<p>a) Surface F. The distance travelled is the shortest. Hence, there is more friction between the tennis ball and the floor.</p> <p>b) John can conclude that when the surface of the floor is rougher the amount of friction increases.</p> <p>c) Some of the kinetic energy of the tennis ball is converted into heat energy and sound energy. Hence, it does not reach the ground.</p>
Q35)	<p>a) Platform A. As the person moves from platform A to platform B, there is more gravitational potential energy than at platform B. Hence, more gravitational potential energy is converted into more kinetic energy when he reaches the ending point.</p> <p>b) Gravitational force and frictional force.</p>

c)

d) He would observe that the 100g iron ball made a deeper hole than

Step 1	Drop the 50g iron ball from a fixed height onto the tray of sand.
Step 2	Measure the depth of the depression/dent made by the ball in the sand using the ruler.
Step 3	Repeat step 1 and 2 for the next iron ball.
Step 4	Release the 100g iron ball and measure the depth made by the 100g iron ball.

the 50g iron ball.

Q36)

a) Y, Z, X

b)

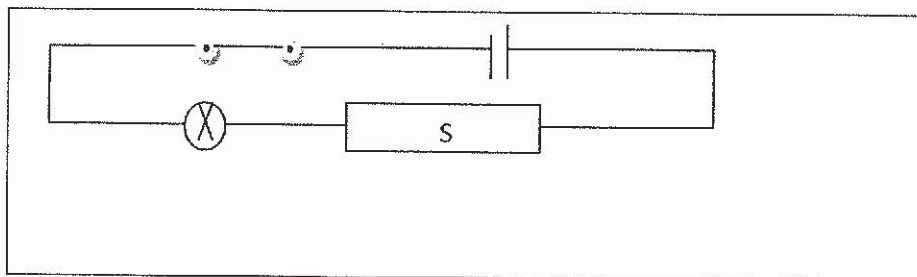

c) Material R because bulb is the brightest and hence R is the best conductor of electricity.

Q37)

a)

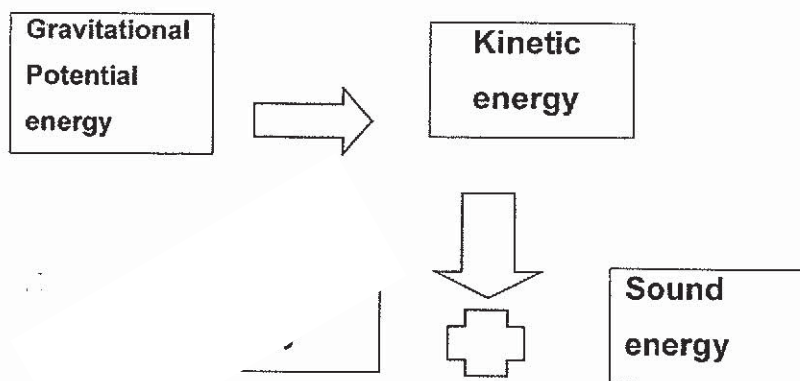

b) The hammer has greater gravitational potential energy. It also has a greater mass and it is raised through a greater height.

Q38)	<p>a)Elastic potential energy.</p> <p>b)Elastic potential energy of the rubber band is converted to kinetic energy of the propelles and is converted into kinetic energy of the moving car and it is converted to heat and sound energy.</p> <p>c)Use a stiffer rubber bands, use more force to push the car, change to smoother surface, use more rubber bands, stretch the rubber bands more.</p>
Q39)	<p>a)B , A</p> <p>b)As set-up A has a steel cup and steel is a better conductor of heat than plastic, the water in A would lose heat more quickly. Though set-up B has a steel spoon, the surface area of the steel spoon in contact with the watere is smaller than the surface area of the steel cup contact with the water in set-up A.</p>
Q40)	<p>a)Magnet X has a greater magnetic strength.</p> <p>b)Gravitational force and magnetic force.</p> <p>c)It repels the globe so the globe floats.</p>