



MARIS STELLA HIGH SCHOOL (PRIMARY)

PRELIMINARY EXAMINATION

SCIENCE

27 AUGUST 2019

BOOKLET A

NAME: _____ ()

CLASS: Primary 6 ()

28 questions

56 marks

Total Time for Booklets A & B: 1 h 45 min

DO NOT OPEN THIS BOOKLET UNTIL YOU ARE TOLD TO DO SO.

FOLLOW ALL INSTRUCTIONS CAREFULLY.

For each question from 1 to 28, four options are given. One of them is the correct answer. Make your choice (1, 2, 3 or 4) and shade the correct oval (1, 2, 3 or 4) on the Optical Answer Sheet (OAS). (56 marks)

1 The diagram below shows the fruit of a plant.

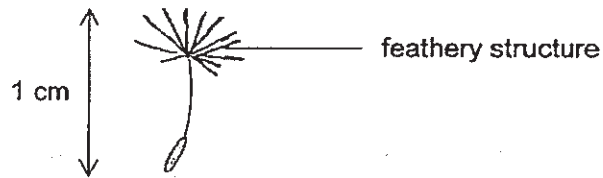

How is the fruit most likely dispersed?

- (1) by wind
- (2) by water
- (3) by animal
- (4) by explosive action

2 Study the classification chart below.

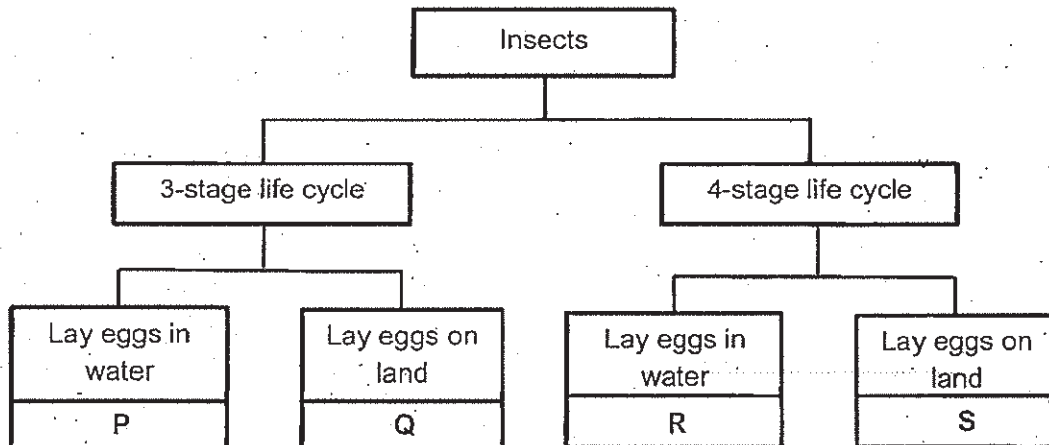

Which insect is most likely a mosquito?

- (1) P
- (2) Q
- (3) R
- (4) S

- 3 Isabel set up an experiment as shown below to investigate the conditions needed by living things to survive. Both jars were left by the window.

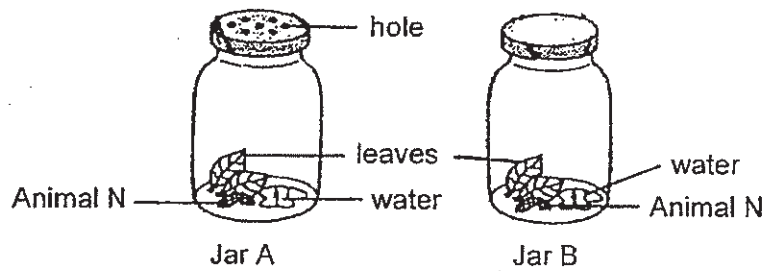

After 2 days, Animal N in Jar B died but Animal N in Jar A remained alive.

Based on the result of the experiment, what can Isabel conclude?

- (1) Living things need air to survive.
- (2) Living things need air and water to survive.
- (3) Living things need air, food and water to survive.
- (4) Living things need air, food, water and light to survive.

- 4 Study the two cells below.

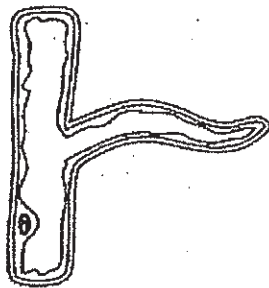

Cell A

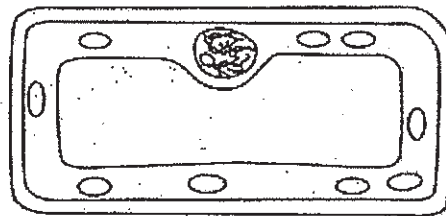

Cell B

Which of the following about cells A and B is correct?

	Cell A	Cell B
(1)	cannot make food	can make food
(2)	cannot undergo cell division	can undergo cell division
(3)	does not have a fixed shape	has a fixed shape
(4)	does not allow any substance to enter	allows some substances to enter

5 Which of the following results in growth of an organism?

- (1) Its cells dividing.
- (2) Its cells absorbing water.
- (3) Its cells becoming bigger.
- (4) Its cells absorbing light energy.

6 A tank containing some aquatic plants and fish is placed in the garden on a sunny day.

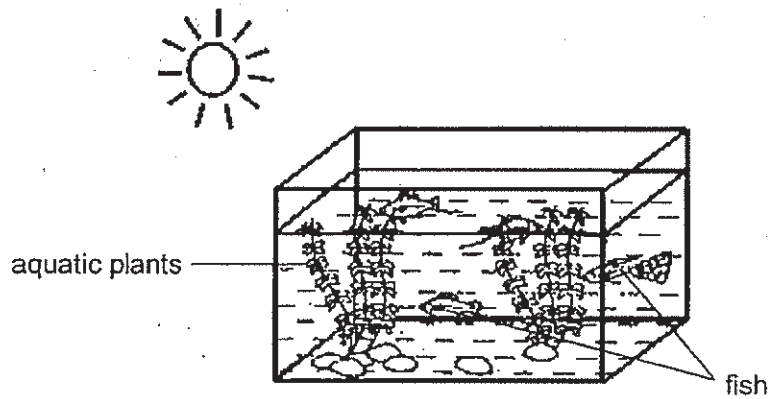

Which of the following factor(s) will affect the amount of oxygen in the water?

- A the number of fish in the tank
- B the material used to make the tank
- C the amount of aquatic plants in the tank

- (1) B only
- (2) C only
- (3) A and C only
- (4) A, B and C

7 Study the flow chart below.

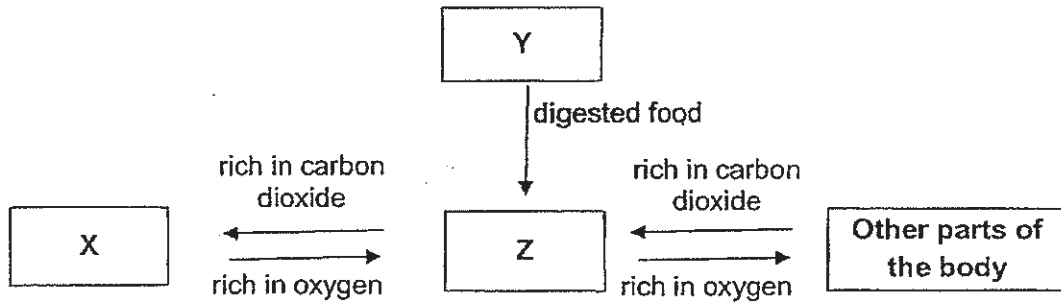

Which of the following correctly represents systems X, Y and Z?

	X	Y	Z
(1)	respiratory	circulatory	digestive
(2)	digestive	respiratory	circulatory
(3)	circulatory	digestive	respiratory
(4)	respiratory	digestive	circulatory

8 The graph below shows how the number of plants X and Y is affected by the temperature of their surroundings.

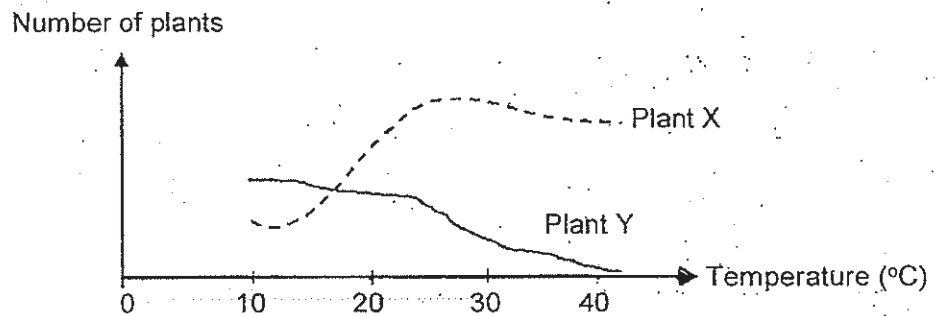

Based on the information given in the graph, which of the following most likely describes plants X and Y?

	Plant X	Plant Y
(1)	thin stem	thick swollen stem
(2)	shallow and narrow roots	deep and widespread roots
(3)	needle-like leaves	broad and large leaves
(4)	brightly-coloured flowers	dull-coloured flowers

9 A rotting log community is shown below.

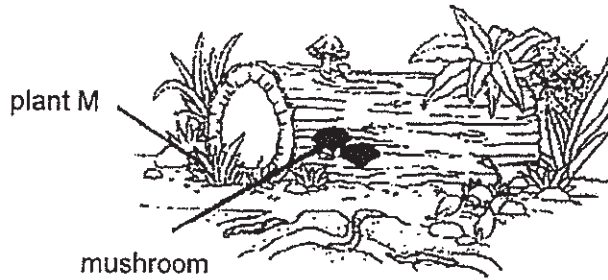

Which of the following shows how plant M and the mushroom benefit from each other?

	What plant M gets from the mushroom	What the mushroom gets from plant M
(1)	oxygen	food
(2)	carbon dioxide	oxygen
(3)	water	carbon dioxide
(4)	mineral salts	water

10 The diagram below represents one of the processes that takes place in plants.

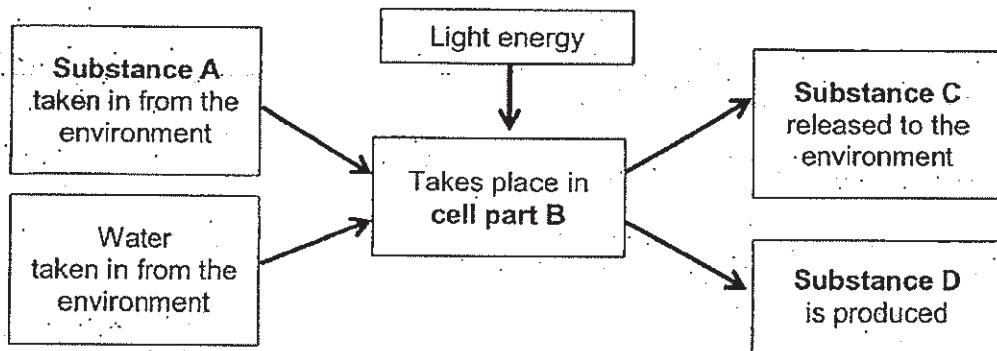

Which of the following correctly identifies A, B, C and D?

	A	B	C	D
(1)	oxygen	chloroplast	carbon dioxide	food
(2)	carbon dioxide	nucleus	oxygen	water
(3)	oxygen	nucleus	carbon dioxide	water
(4)	carbon dioxide	chloroplast	oxygen	food

- 11 Three flowers, P, Q and R, from the same plant have different flower parts removed as shown below.

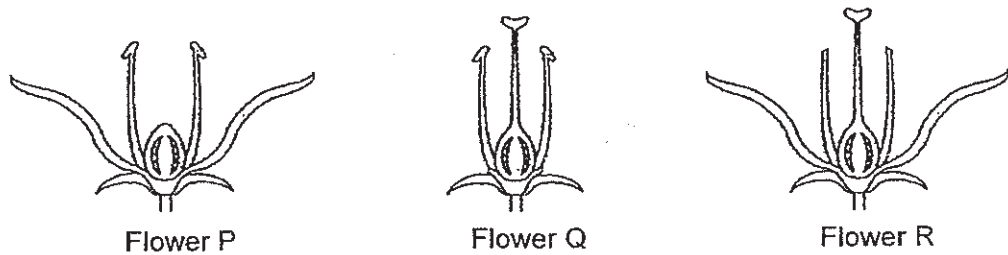

Which of the flower(s) can develop into a fruit?

- (1) Q only
 (2) P and R only
 (3) Q and R only
 (4) P, Q and R
- 12 Gabriel set up the apparatus as shown below. In the set-up, the drop of red ink prevents air from entering the test tube.

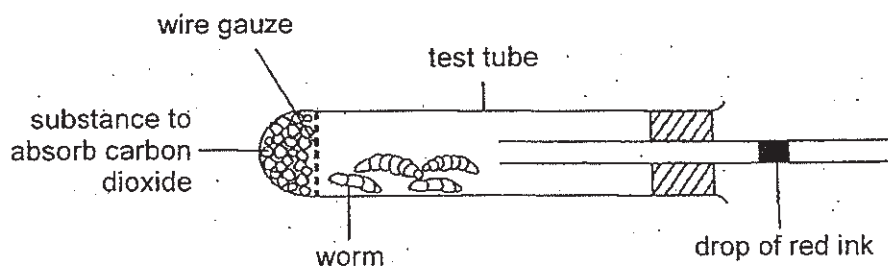

After 1 hour, the red ink drop moved.

Which of the following shows the correct observation and reason for the observation?

	Direction the red ink drop moved	Reason
(1)	Away from the test tube	Amount of oxygen in the test tube increased
(2)	Away from the test tube	Amount of carbon dioxide in the test tube increased
(3)	Towards the test tube	Amount of oxygen in the test tube increased
(4)	Towards the test tube	Amount of carbon dioxide in the test tube increased

- 13 The food chains below show how 4 organisms depend on one another in a garden community.

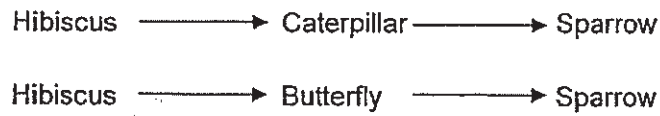

The bar graph below shows the different number of organisms spotted in the garden over 2 months.

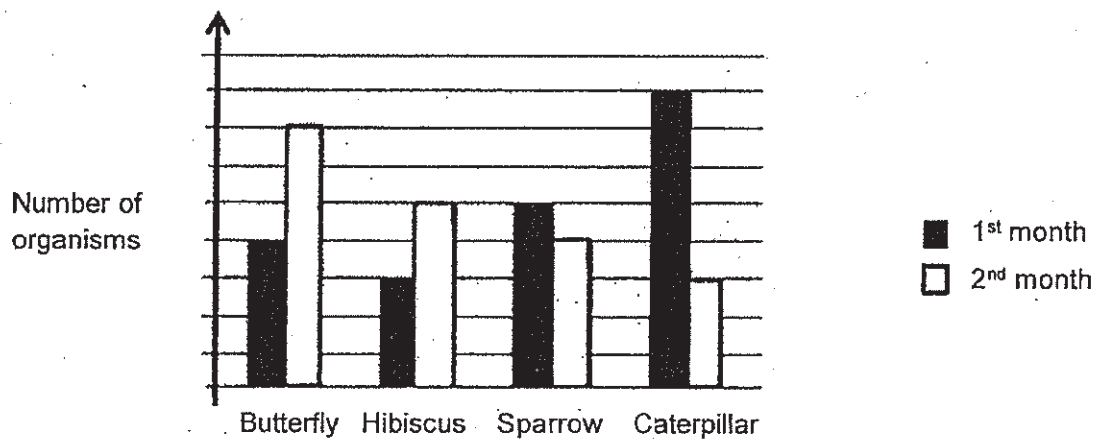

Based only on the graph, which one of the following reasons could explain why the number of caterpillars decreased in the second month?

- (1) There was less food for the caterpillars.
- (2) The caterpillars became adult butterflies.
- (3) The caterpillars were killed by pesticides.
- (4) There were more predators of the caterpillars.

14 The diagram below shows a food web in a rice field.

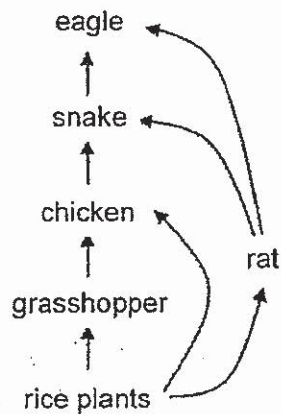

After Animal X was released into the field, the number of grasshoppers increased and the number of rats decreased.

Which organism did Animal X feed on?

- (1) snake
- (2) chicken
- (3) rice plants
- (4) grasshopper

15 The diagrams below show parts of the respiratory system of a leaf and a fish.

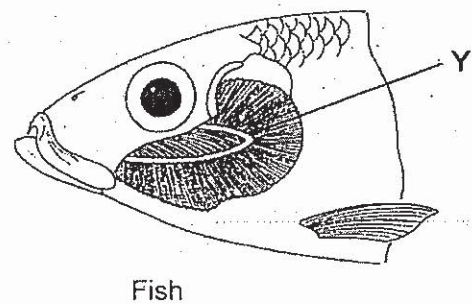
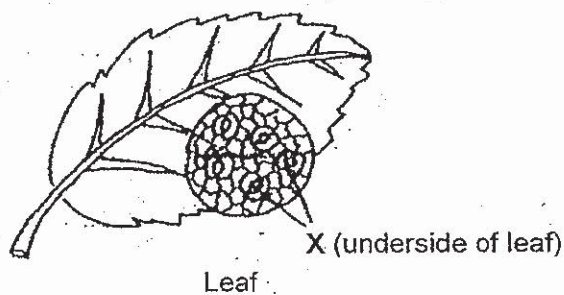

Which one of the following statements is true about parts X and Y?

- (1) X and Y store gases.
- (2) X takes in sunlight but Y takes in water.
- (3) X and Y allow carbon dioxide to move through them.
- (4) X and Y take in oxygen and give out carbon dioxide only.

16 The pictures below show insects A and B.

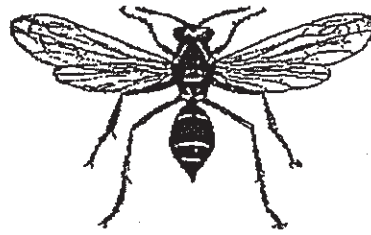

Insect A

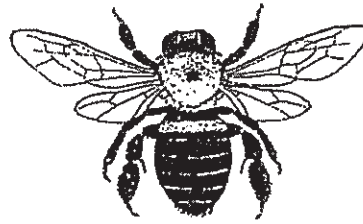

Insect B

Insects A and B look alike. Insect B can sting its predator but insect A cannot.

How does insect A benefit from looking like insect B?

- A It helps deter predators.
- B It helps attract mates for reproduction.
- C It helps insect A camouflage amongst its surrounding.

- (1) A only
- (2) A and C only
- (3) B and C only
- (4) A, B and C

17 The materials below are classified into 2 groups.

Group 1	Group 2
wood plastic rubber	iron steel copper

What property are the materials classified according to?

- (1) absorbency
- (2) transparency
- (3) heat conductivity
- (4) ability to be magnetised

- 18 The diagram below shows the structure of a house in a cold country.

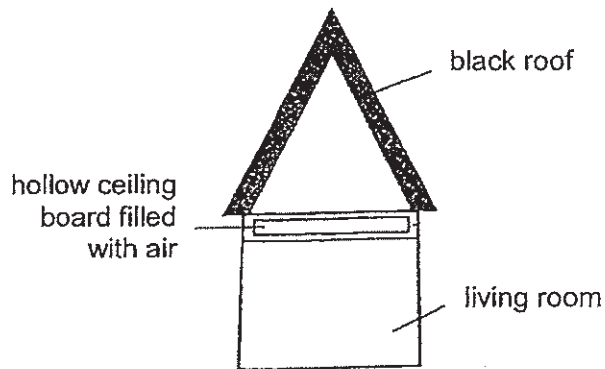

Which statement explains why the temperature in the living room is higher than the air outside the house at night?

- (1) The black roof reduces heat gain in the day.
- (2) The air in the ceiling board reduces heat loss at night.
- (3) The air in the ceiling board is a good conductor of heat.
- (4) The black roof gains heat from the surroundings at night.

- 19 The paper lantern below rises into the air after the candle is lighted.

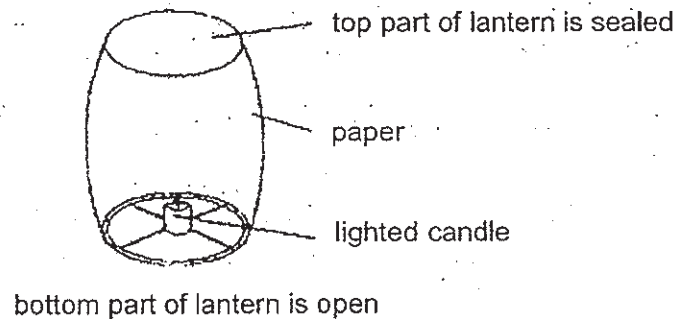

Which form of energy does **not** help the paper lantern to rise?

- (1) heat
- (2) light
- (3) kinetic
- (4) potential

20 The diagram below shows 3 ring magnets.

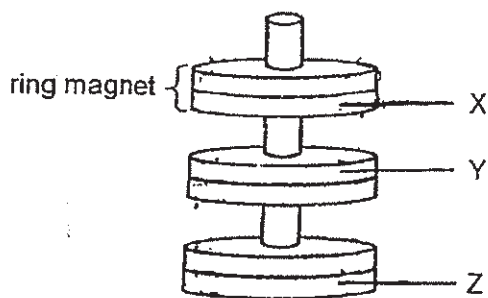

Which of the following represents the poles X, Y and Z?

	X	Y	Z
(1)	north	north	south
(2)	north	south	south
(3)	south	south	north
(4)	south	south	south

21 The flow chart below describes the properties of substances P, Q, R and S at 10°C.

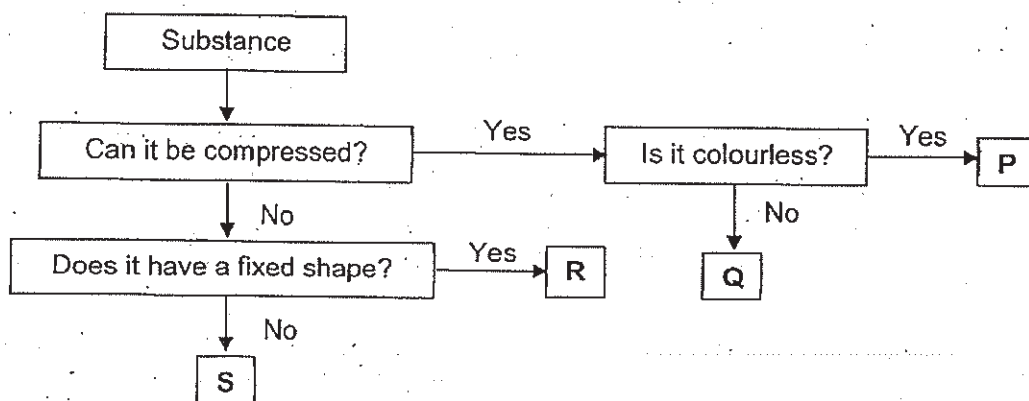

Y is a colourless substance which freezes at 18°C and boils at 65°C.

Which substance in the flow chart represents Y at 10°C?

- (1) P
- (2) Q
- (3) R
- (4) S

22 What is the effect of gravity on matter around us?

- (1) Matter has mass.
- (2) Matter has weight.
- (3) Matter occupies space.
- (4) Matter can change states.

23 The diagrams below show how wires in a circuit card are connected and a circuit tester.

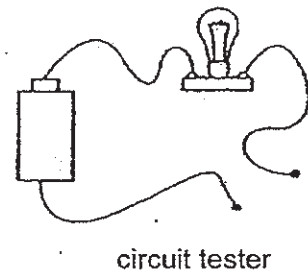
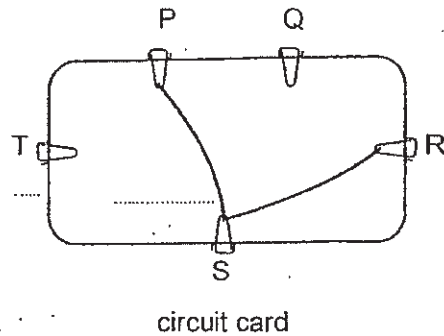

Which of the following tables correctly shows the lighting up of the bulb when the circuit tester is used to test the circuit card?

(1)

Wires	Bulb lighted up
P and Q	No
P and R	Yes
S and Q	Yes

(2)

Wires	Bulb lighted up
Q and R	No
P and T	No
P and S	No

(3)

Wires	Bulb lighted up
P and R	Yes
S and R	Yes
T and S	Yes

(4)

Wires	Bulb lighted up
P and S	Yes
R and T	No
Q and S	No

- 24 An equal amount of water was poured into four containers. The containers were then left under different conditions as described in the table below.

	Container			
	A	B	C	D
Presence of wind	Yes	No	No	Yes
Temperature of water (°C)	60	90	70	60
Exposed surface area (cm ²)	50	50	70	70

Which of the following pairs of containers should be used to find out if the exposed surface area of a container affects the rate of evaporation?

- (1) A and C
 (2) A and D
 (3) B and C
 (4) B and D
- 25 Which diagram correctly represents the water cycle?

(1)

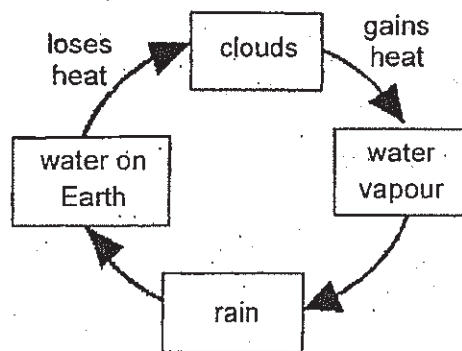

(2)

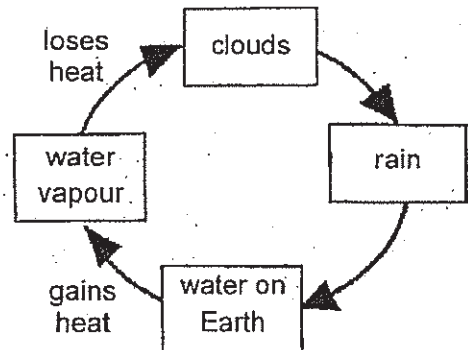

(3)

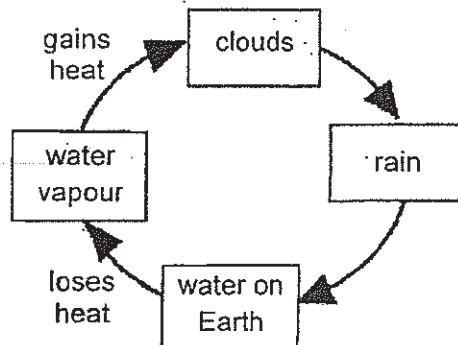

(4)

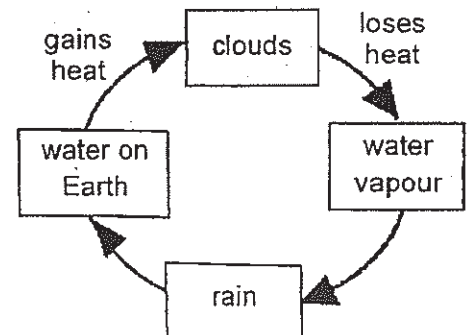

- 26 The diagram below shows a plank leaning against a wall. After some time, the plank slid down towards the ground.

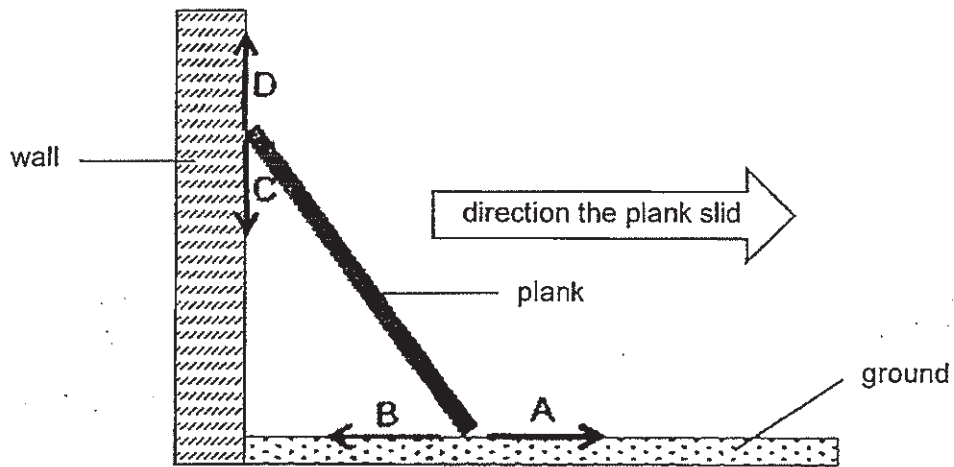

Which two arrows show the direction of frictional force when the plank is sliding down towards the ground?

- (1) A and C
 - (2) A and D
 - (3) B and C
 - (4) B and D
- 27 Yasmin had two identical pieces of papers, X and Y. She crushed one of the papers into a ball. Both X and Y were then dropped from the same height.

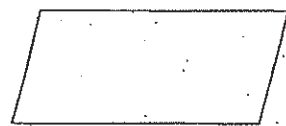

X
(uncrushed paper)



Y
(crushed paper)

She observed that Y reached the ground before X.

Which of the following statements explains her observation?

- (1) Y is lighter than X.
- (2) Y had less air resistance than X.
- (3) Y had more gravitational potential energy than X.
- (4) Y had more gravitational force acting on it than X

- 28 Yong Jie set up an experiment using three different types of paper, A, B and C, and a piece of cardboard as shown below. Pin-sized holes were poked in the centre of each type of paper and the cardboard.

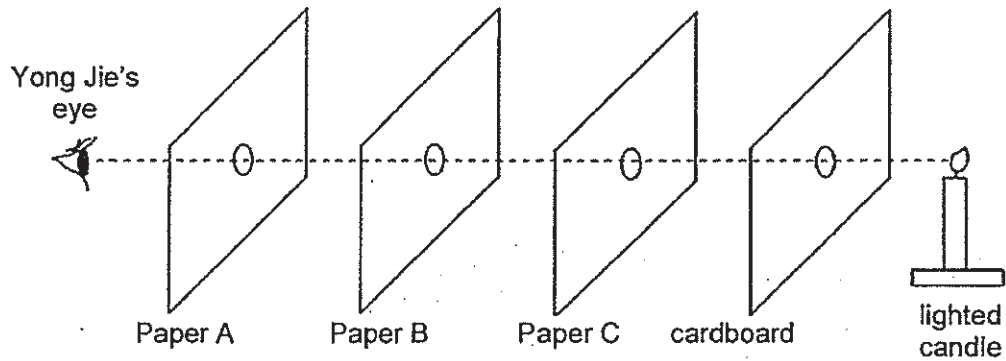

From the experiment, Yong Jie observed the following:

- When he arranged all the holes in line, he saw the lighted candle.
- When he shifted only Paper A to his right, he could not see the lighted candle.
- When he shifted only Paper B to his right, he could still see the lighted candle.

What could Yong Jie conclude from his experiment?

	Paper A allows light to pass through	Paper B allows light to pass through	Paper C allows light to pass through
(1)	No	Yes	No
(2)	Yes	Not possible to tell	Not possible to tell
(3)	No	Yes	Not possible to tell
(4)	Not possible to tell	Yes	No

End of Booklet A

Go on to Booklet B



MARIS STELLA HIGH SCHOOL (PRIMARY)

PRELIMINARY EXAMINATION

SCIENCE

27 AUGUST 2019

BOOKLET B

NAME: _____ ()

CLASS: Primary 6 ()

13 questions

44 marks

Total Time for Booklets A & B: 1 h 45 min

DO NOT OPEN THIS BOOKLET UNTIL YOU ARE TOLD TO DO SO.

FOLLOW ALL INSTRUCTIONS CAREFULLY.

Booklet A: _____ / 56

Booklet B: _____ / 44

Grand Total: _____ / 100

Parent's Signature: _____

For questions 29 to 41, write your answers in this booklet. The number of marks available is shown in brackets [] at the end of each question or part question. (44 marks)

29 The diagram below is an incomplete representation of the human circulatory system.

(a) Draw two arrows (\rightarrow) to complete the diagram.

[1]

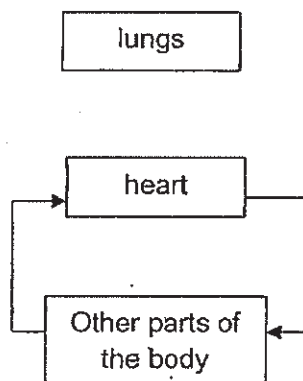

(b) The plant transport system consists of two different types of tubes that carry different materials.

Name the tubes in the blanks below.

[2]

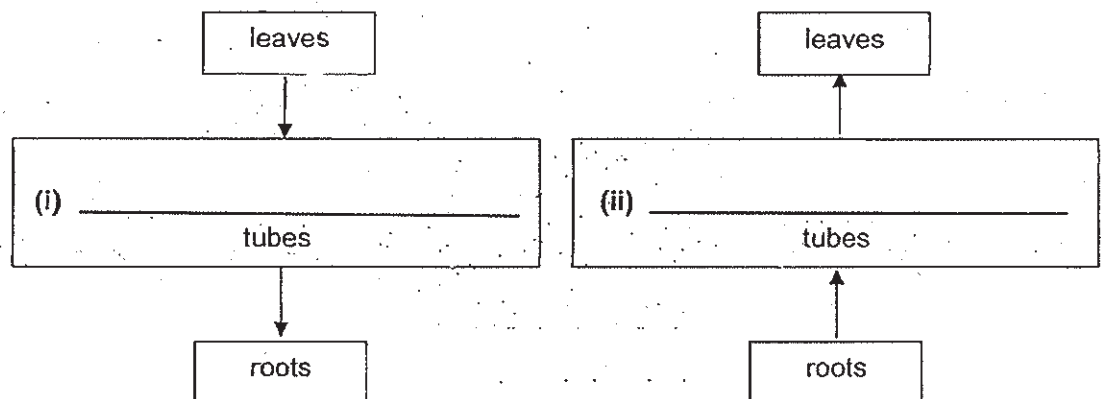

30 The diagram below shows the negative impacts of human activities on the environment.

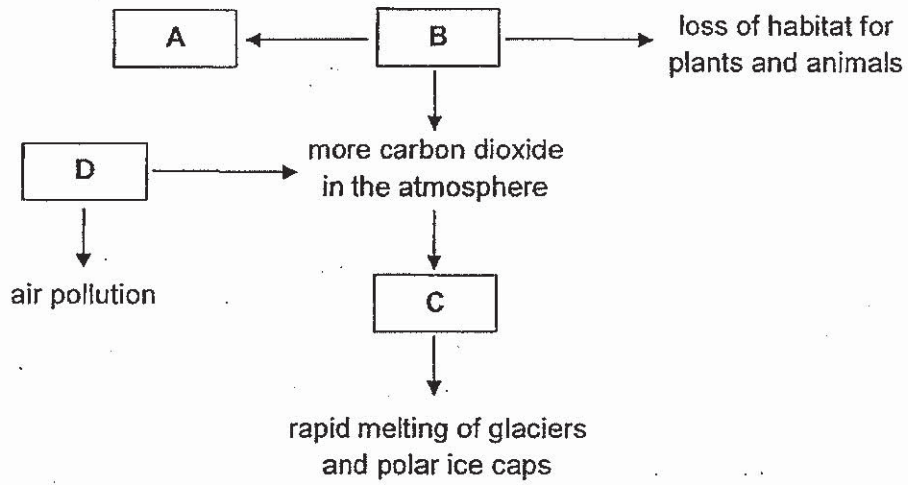

(a) Which of the following best represent A, B, C and D? [2]

burning of fossil fuels	deforestation	greenhouse effect
global warming	soil erosion	destruction of ozone layer

A: _____

B: _____

C: _____

D: _____

(b) Explain how soil erosion can have a negative effect on aquatic plants in the rivers: [1]

- 31 Plant P has modified leaves which are bright pink in colour. These bright pink leaves surround small white flowers and help in reproduction. The remaining leaves on Plant P are green.

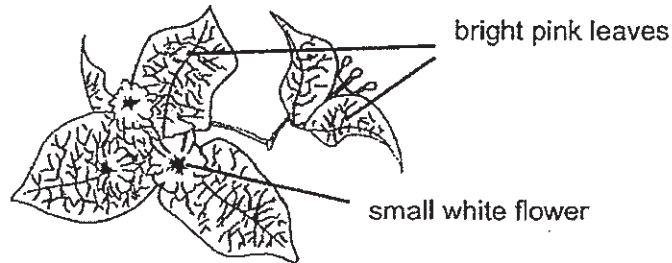

Plant P

- (a) Name the process the bright pink leaves help Plant P in. [1]

- (b) How do the bright pink leaves help Plant P in reproduction? [1]

- (c) Other than being small and white, state another likely characteristic of the flowers. [1]

32 Study the food web below.

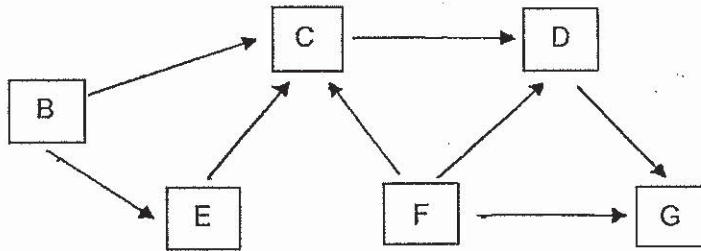

(a) Which organism(s), B to G, is/are both prey and predator? [1]

(b) Explain how the population of F will be affected if there is a long period without rain. [1]

(c) If a disease was to wipe out the population of B, which organism, C or E, will be more affected? Explain your answer. [2]

- 33 Muthu set up an experiment as shown below to compare the amount of heat gained by blocks A and B. Blocks A and B are identical. They are made of the same material and have the same volume. Both heat sources give off the same amount of heat.

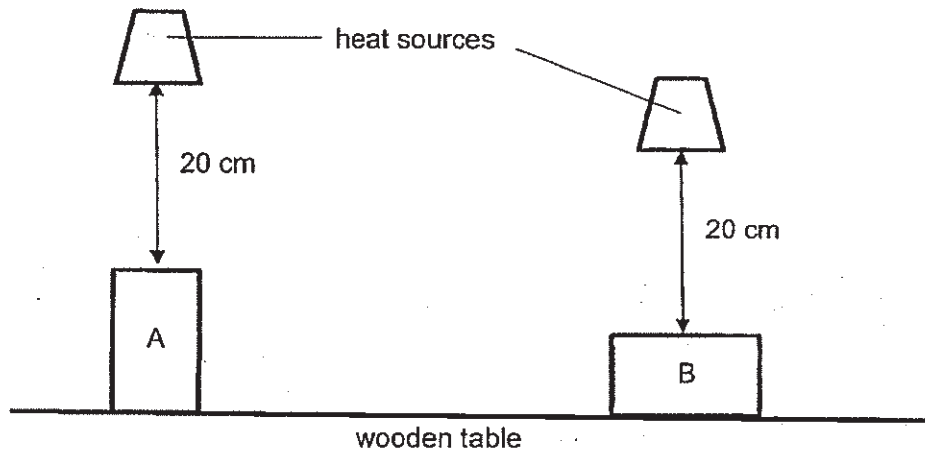

Muthu measured the temperature of blocks A and B over time.

- (a) The table below shows part of his result's table.

Time (min)	Temperature of blocks ($^{\circ}\text{C}$)	
	A	B
0	28	?

To obtain accurate results, what should the temperature of block B be at the start of experiment? [1]

- (b) After 10 minutes, block B had a higher temperature than block A. Explain why. [1]

	2
--	---

(Go on to the next page)

Animal X lives in the desert. During the day, Animal X moves around with its tail above its body. At night, it moves around with its tail on the ground.

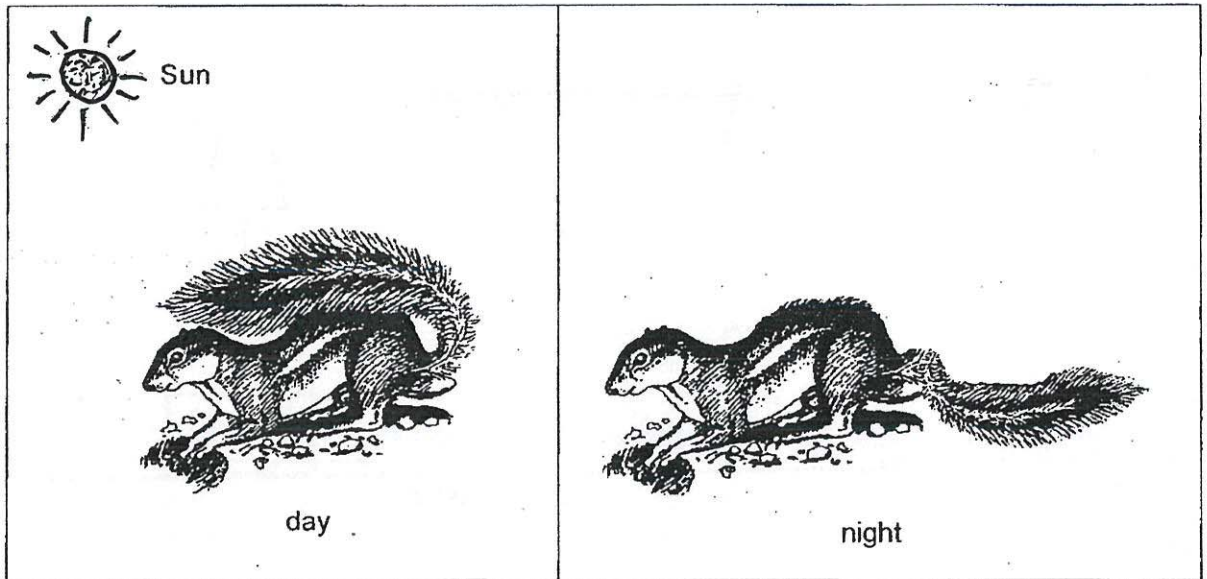

(c) Based on Muthu's findings, explain ~~how moving around~~ with its tail above its body helps Animal X stay cool in the day.

- 34 Birds Y and Z build different types of nests to lay and store their eggs. For both birds, their young stay in their nests and are taken care of by their parents.

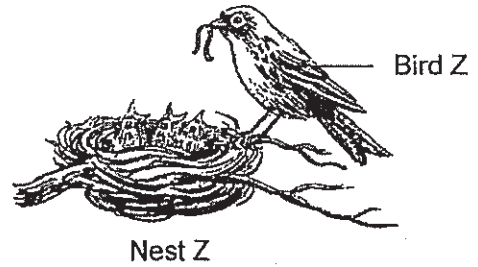
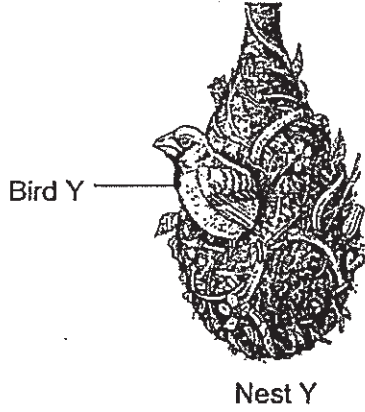

- (a) State two advantages Nest Y has over Nest Z in terms of increasing the chances of survival of the young of the birds. [2]

(1) _____

(2) _____

- (b) State the advantage Nest Y has over Nest Z when it rains. [1]

- 35 Amy heated substance L. After 10 minutes, L reached its boiling point. She continued heating L for another 10 minutes before turning off the heat source. She then allowed L to cool for 10 minutes.

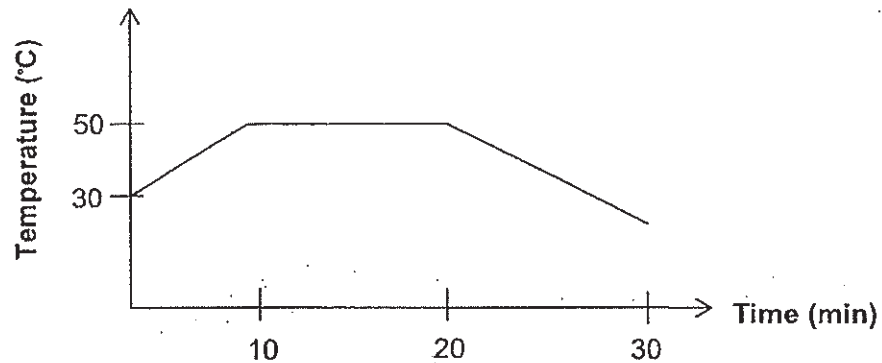

- (a) Based on the given information, would you be able to tell the state of L at 0°C? Explain your answer. [1]

- (b) Identify the state L is in at 40°C. [1]

- (c) At 40°C, substance L is placed in a syringe as shown in the diagram below.

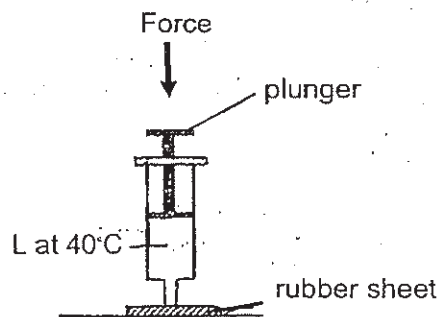

- Will the plunger move upwards, downwards or remain in the same position when force is exerted in the direction as shown above? Explain your answer. [1]

- 36 Eleanor conducted an experiment to find out how the mass of toy cars will affect how fast they move. She pushed 2 similar toy cars of different mass, one at a time, from the same starting line as shown below.

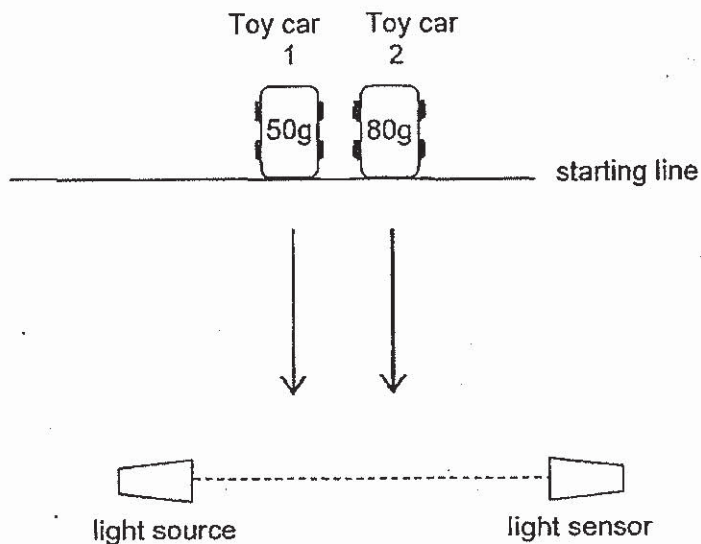

The table below shows the amount of light detected by the light sensor over time. The light sensor started recording the amount of light when each car is pushed off the starting line.

Time (s)	Amount of light detected by the light sensor (units)	
	Toy Car 1 (50 g)	Toy Car 2 (80 g)
0	2500	2500
0.5	2500	2500
1.0	0	2500
1.5	2500	0
2.0	2500	2500

- (a) Which toy car, 1 or 2, moved faster? Using the data in the table above, explain your answer. [1]

	1
--	---

(b) Based on the data in the table, what is the relationship between the mass of the car and how fast it moves? [1]

(c) Based on the data in the table, state the property of the toy cars. [1]

(d) Was the experiment conducted in a completely dark room? Explain your answer. [1]

(e) State another important variable that must be kept the constant for the experiment. [1]

- 37 When set-up A was placed in a basin of ice cubes, the balloon in the bottle became bigger as shown in the diagram below.

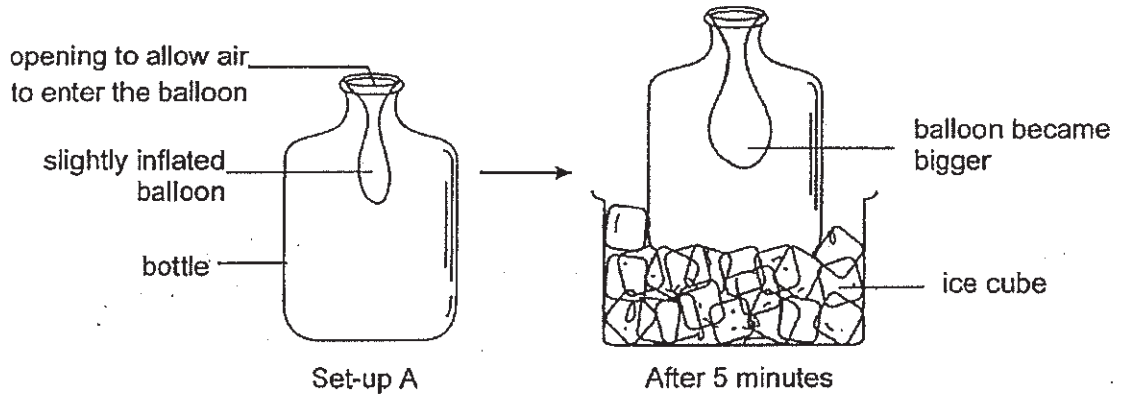

- (a) Explain why the balloon became bigger after the bottle was placed in the basin of ice cubes. [2]

- (b) What will happen to the balloon if set-up A was placed in a basin of hot water? [1]

- 38 Sam has 3 objects, X, Y and Z, made of different materials. He connected the 3 objects to a circuit as shown below.

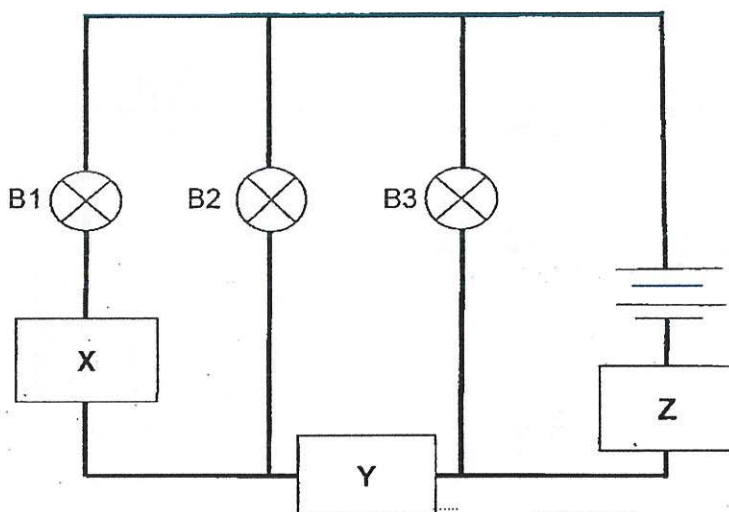

- (a) When connected, only 2 of the bulbs are lit.

Which are the 2 bulbs, B1, B2 or B3, that are lit?

[1]

- (b) Each of the objects, X, Y and Z, is made of one of the materials listed in the table below.

Material
iron
rubber
copper

- (i) Sam can only be sure of the material of one the objects.

Which object, X, Y or Z, is that?

[1]

- (ii) What material is the object identified in (i) made of?

[1]

- 39 In the four set-ups below, identical steel balls are hung on identical strings of the same length. Objects X, Y and Z are placed under position B in set-ups X, Y and Z respectively.

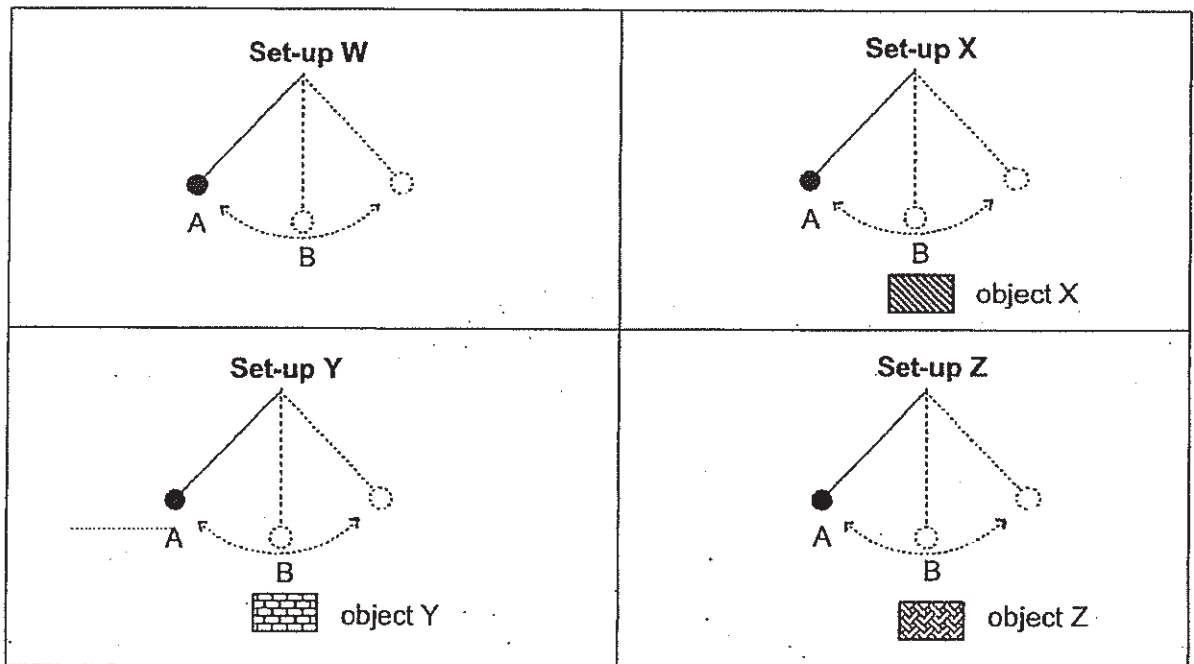

The four steel balls were released from position A and allowed to swing freely till they came to a complete stop. The time taken for the balls to come to a complete stop is shown in the table below.

Set-up..	Time taken for the ball to stop completely (s)
W	20
X	2
Y	5
Z	20

- (a) The items listed in the table below are objects X, Y and Z. Based on the results, identify objects X, Y and Z by writing the letters in the space provided. [1]

Items	Object
Magnet with strong magnetism	
Magnet with weak magnetism	
Wooden box	

	1
--	---

- (b) Two identical steel balls, P and Q, were placed next to object Y as shown below.

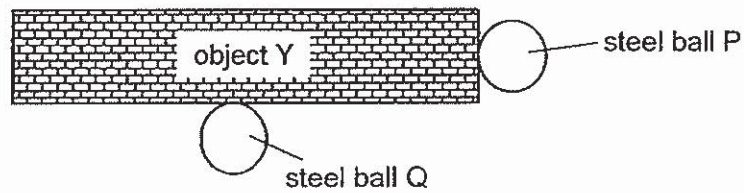

When object Y is lifted, only ball P remained attached to object Y.
Explain why this is so.

[1]

- (c) After object Y was heated for 5 minutes, ball P could no longer be lifted up together with object Y. Explain why.

[1]

- (d) What can be done to increase reliability of the results?

[1]

- 40 Blocks G and K are made of the same material. However, block G has a bigger mass than block K. After block G was released from plank P, it hit block K at the bottom of the slope. Block K moved d distance and then came to a stop.

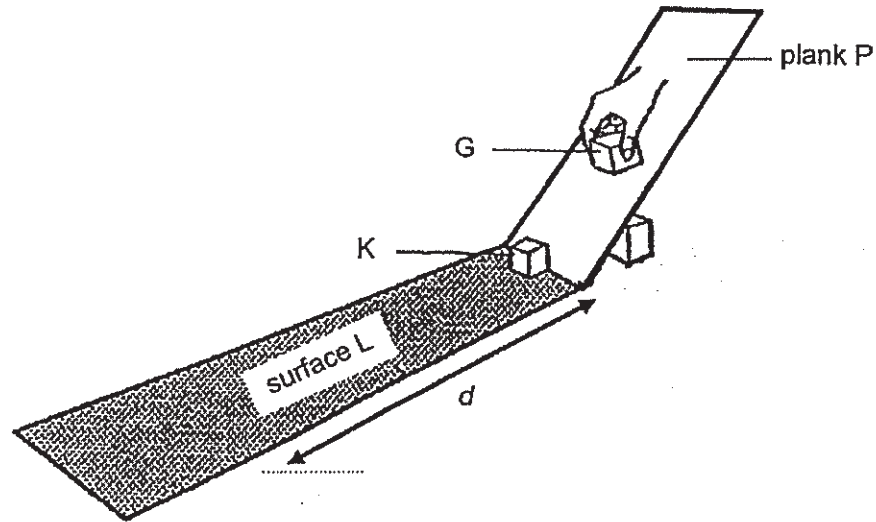

- (a) Name the forces present when block G moved down the slope. [1]
-
- (b) Explain why block K stopped moving after d distance. [1]
-
-
- (c) Without using different apparatus, suggest one way to increase distance d . [1]
-
- (d) How would distance d change if the positions of blocks G and K are exchanged and block K is released to hit block G? [1]
-

- 41 The diagram below shows a hydroelectric power station. The turbine is attached to the generator.

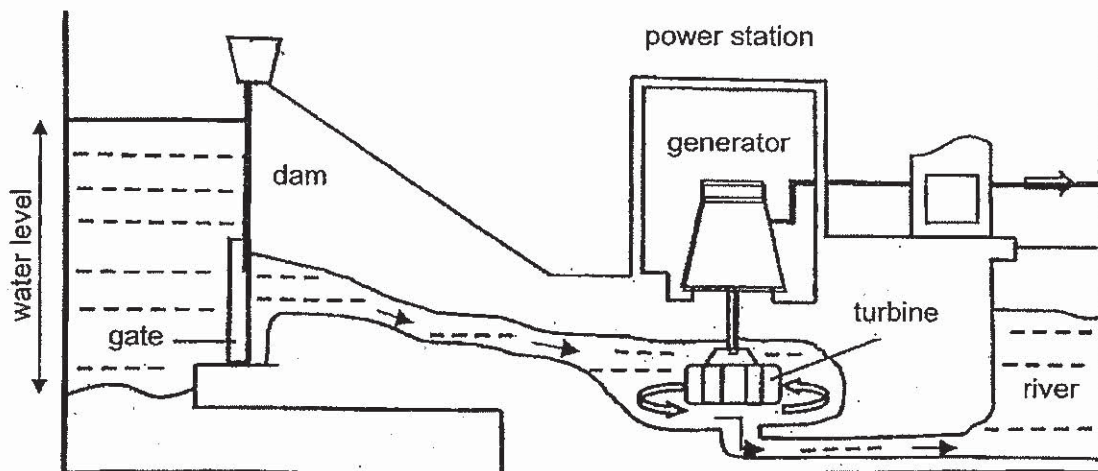

- (a) Based on the diagram above, fill in the boxes to show the energy conversion. [1]

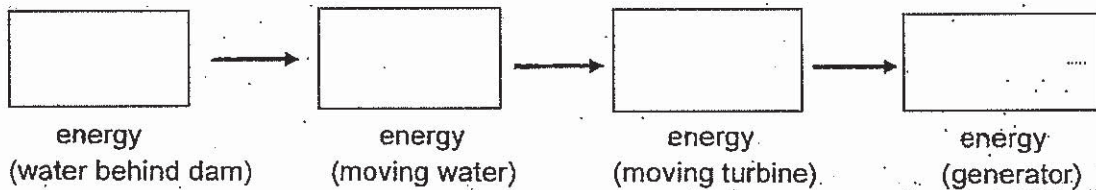

- (b) During long periods without rain, the water level behind the dam decreases greatly. Explain how this will affect the amount of electricity generated. [2]

End of Booklet B

	3
--	---

ANSWER KEY

YEAR : 2019
LEVEL : PRIMARY 6
SCHOOL : MARIS STELLA
SUBJECT : SCIENCE
TERM : SA 2

BOOKLET A

Q1	Q2	Q3	Q4	Q5	Q6	Q7	Q8	Q9	Q10
1	3	1	1	1	4	4	3	2	4
Q11	Q12	Q13	Q14	Q15	Q16	Q17	Q18	Q19	Q20
3	4	2	2	3	1	3	2	2	4
Q21	Q22	Q23	Q24	Q25	Q26	Q27	Q28		
3	2	4	2	2	4	2	3		

BOOKLET B

Q29 (a)

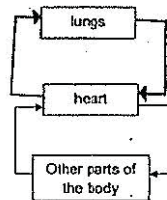

- (b) (i) Food-carrying
(ii) Water-carrying

- Q30 (a) A: Soil erosion
B: Deforestation
C: Global warming
D: Burning of fossil fuels

- (b) When soil erosion occurs, the soil slides into rivers and they blocked aquatic plants taking in sunlight for photosynthesis. So the aquatic plants make less food and might die.

Q31 (a) Pollination

- (b) They attract insects to pollinate it and after it is pollinated, it can reproduce.

(c) Sweet smell.

Q32 (a) Only

- (b) Without rain, the plant cannot take in water thus it will photosynthesize lesser and make less food, so when it lacks food, it will die and population will decrease.

- (c) E . Organism B is only food source of E, organism E will decrease rapidly. However, Organism C feed on F and E. So C has alternative food but E does not. At the end, organism E will decrease more organism C.
- Q33 (a) It should be at 28°C.
- (b) As more of B exposed to the heat source than A, it gains more heat faster and thus has a higher temperature than A.
- (c) By lifting its tail up, less of X's body is exposed to the hot ground and touching the hot ground so it gain less heat and stay cooler.
- Q34 (a) (1) Nest Y is more covered than Z so predators have a harder time going in to Y whereas predators can just swoop down to eat Z's young.
- (2) The young in nest Y will not be washed by rain but Z's young will.
- (b) Y can shelter the young better than Z.
- Q35 (a) No, L may be a liquid or solid at 0°C since the freezing and melting point is unknown.
- (b) Liquid.
- (c) It will remain the same. As L is at liquid state at 40°C, it cannot be compressed so the plunger will not move.
- Q36 (a) Toy car 1 moved faster, At 1.0 seconds, toy car 1 blocked the light sensor while toy car 2 blocked the light at 1.5 seconds. This show that 1 was faster and blocked the light first.
- (b) As the mass of the car increases, it travels slower.
- (c) The toy cars are made of an opaque which material does not allow light to pass throught it.
- (d) Yes. No light was detected by the sensor when the car blocked the light.
- (e) The amount exerted on each car pushed.
- Q37 (a) The air will contract, letting the surroundings enter the balloon.
- (b) The balloon will become smaller.
- Q38 (a) B.
- (b) (i) X
(ii) Rubber.

Q39 (a)

Items	Object
Magnet with strong magnetism	X
Magnet with weak magnetism	Y
Wooden Box	Z

- (b) As Y is a magnet, its magnetism is strongest at its poles so P could stay attracted while Q dropped.
- (c) As Y was heated, it lost some of its magnetism and did not have enough magnetic strength to attract P.
- (d) Repeat the experiment at least 3 times.
- Q40 (a) Frictional force and gravitational force.
- (b) All kinetic energy is converted to heat and sound energy.
- (c) Slant P to a higher angles.
- (d) d will be shorter.
- Q41 (a) Gravitational potential → kinetic → kinetic → Electrical
- (b) When there is lesser water behind the dam, the water has less gravitational potential energy and less gravitational potential energy is converted to less kinetic energy in the moving water which is transferred to the moving turbine which is converted to less electrical energy is the generator.

3
ZND

