

Name: ..... (     )     Class: Sec .....

# Queenstown Secondary School

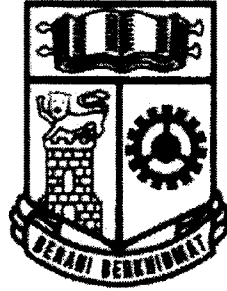

**Preliminary Examination 2022**  
**Secondary Four Express / Five Normal (Academic)**  
**Mathematics Paper 1**  
**4048/01**

**23 August 2022**  
**Tuesday**  
**Setter: Mr Lim Li Cheng, Mdm Jayasolai**

**Time: 0800 – 1000**  
**Duration: 2 hours**

Candidates answer on the Question Paper.

## READ THESE INSTRUCTIONS FIRST

Write your name, class and index number on all the work you hand in.  
 Write in dark blue or black pen.  
 You may use an HB pencil for any diagrams or graphs.  
 Do not use staples, paper clips, highlighters, glue or correction fluid.

Answer all questions.

If working is needed for any question it must be shown with the answer.  
 Omission of essential working will result in loss of marks.  
 The use of an approved scientific calculator is expected, where appropriate.  
 If the degree of accuracy is not specified in the question, and if the answer is not exact,  
 give the answer to three significant figures. Give answers in degrees to one decimal place.  
 For  $\pi$ , use either your calculator value or 3.142, unless the question requires the answer in  
 terms of  $\pi$ .

The number of marks is given in brackets [ ] at the end of each question or part question.

For Examiner's Use
80

This document consists of **20** printed pages, including this cover page.

**[Turn over**

**Mathematical Formulae***Compound interest*

$$\text{Total amount} = P \left( 1 + \frac{r}{100} \right)^n$$

*Mensuration*

$$\text{Curved surface area of a cone} = \pi r l$$

$$\text{Surface area of a sphere} = 4\pi r^2$$

$$\text{Volume of a cone} = \frac{1}{3} \pi r^2 h$$

$$\text{Volume of a sphere} = \frac{4}{3} \pi r^3$$

$$\text{Area of a triangle } ABC = \frac{1}{2} ab \sin C$$

$$\text{Arc length} = r\theta, \text{ where } \theta \text{ is in radians}$$

$$\text{Sector area} = \frac{1}{2} r^2 \theta, \text{ where } \theta \text{ is in radians}$$

*Trigonometry*

$$\frac{a}{\sin A} = \frac{b}{\sin B} = \frac{c}{\sin C}$$

$$a^2 = b^2 + c^2 - 2bc \cos A$$

*Statistics*

$$\text{Mean} = \frac{\sum fx}{\sum f}$$

$$\text{Standard deviation} = \sqrt{\frac{\sum fx^2}{\sum f} - \left( \frac{\sum fx}{\sum f} \right)^2}$$



4

- 4 Shaqil invests \$3500 at a simple interest of 2.3% per year for 5 years.

Calculate the total value of his investments at the end of 5 years.

*Answer* \$ ..... [2]

---

- 5  $p$  is inversely proportional to  $\sqrt[3]{q}$ .  
The value of  $q$  is decreased by 87.5%.

Calculate the percentage increase in the value of  $p$ .

*Answer* ..... [2]

---

5

- 6 A survey was conducted to find the number of occupants in each unit of an apartment.  
The results are shown in the table below.

Number of occupants	2	3	4	5	6	7
Number of units	3	6	$x$	4	10	5

- (a) If the mode is 4, write down the smallest possible value of  $x$ .

*Answer* ..... [1]

- (b) If the median is 5, write down the greatest possible value of  $x$ .

*Answer* ..... [1]

- 7 By writing each value correct to 1 significant figure, estimate the value of

$$\sqrt{\frac{2.39 \times 8.46}{96.2}}$$

Show your working.

*Answer* ..... [2]

6

- 8 The volume of a cuboid is  $1296 \text{ cm}^3$ .  
The area of the **largest** face is  $162 \text{ cm}^2$ .  
The dimensions of the cuboid have integer values.

Find the dimensions of the cuboid.

*Answer* .....cm by .....cm by.....cm [2]

---

- 9 An aeroplane leaves Istanbul, in Turkey, at 01 45 local time.  
The distance from Istanbul to Singapore is 9535.25 km.  
The average speed of the aeroplane is 887 km/h.  
The aeroplane arrives in Singapore at 17 30 local time.

Find the time difference between Istanbul and Singapore, stating whether the time in Singapore is ahead or behind the time in Istanbul.  
Show your working.

*Answer* Singapore is ..... by ..... hours [3]

---

7

10 (a) Solve  $\frac{5}{x} + 14 = 7$ .

Answer ..... [1]

(b) Express as a single fraction in its simplest form  $\frac{3x-2}{5} - \frac{x+1}{4}$ .

Answer ..... [2]

11

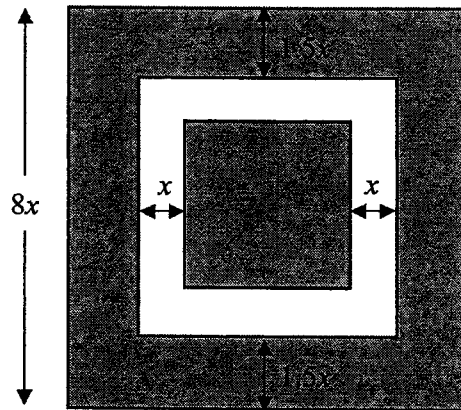

The diagram shows three squares.  
 The length of the side of the largest square is  $8x$  cm.  
 A point is chosen at random inside the largest square.

Find the probability that this point lies inside the shaded region.

Answer ..... [3]

- 12 A group of 200 adults took part in a quiz.  
The table below shows the distribution of the times taken to complete the quiz.

Time ( $t$ min)	$20 < t \leq 30$	$30 < t \leq 40$	$40 < t \leq 50$	$50 < t \leq 60$	$60 < t \leq 70$
Number of adults	25	87	60	23	5

- (a) Calculate an estimate of mean time.

Answer ..... [1]

- (b) This accurate pie chart shows the age groups of a second group of adults taking part in the quiz.

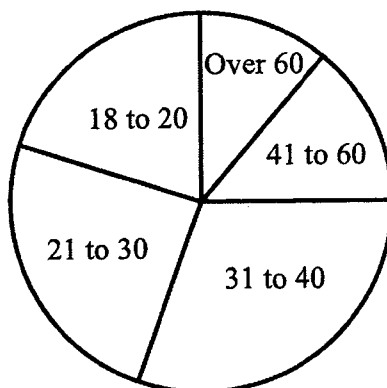

- (i) Find the percentage of adults that were aged 41 to 60 years old, that took part in the quiz.

Answer .....% [1]

- (ii) Explain why it is not possible to calculate the number of adults over 60 years old that took part in the quiz.

.....  
..... [1]



- 13 In a regular polygon, the ratio interior angle : exterior angle = 7 : 2.

Calculate the number of sides of the polygon.

*Answer* ..... [3]

---

- 14 (a) Expand and simplify  $(3x+4k)^2$ .

*Answer* ..... [2]

- (b) Given that  $(3x+4k)^2 = 9x^2 - 48x + 64$ , find the value of  $k$ .

*Answer*  $k =$  ..... [1]

---

10

- 15 In the figure below,  $BF$  and  $CE$  are parallel lines.  
 $E$  is the midpoint of  $FD$  and  $AF = \frac{5}{2}FE$ .

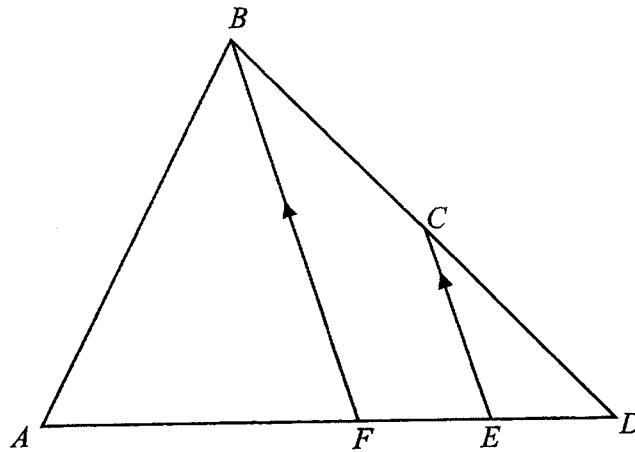

Find the ratio of the area of triangle  $CED$  to that of triangle  $ABF$ .

*Answer* ..... : ..... [3]

---

16 The Venn diagram shows the elements of  $\xi = \{\text{integers } x : 1 \leq x \leq 14\}$ .

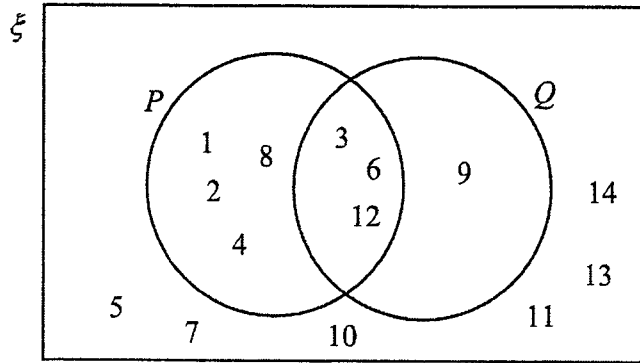

(a) Underline the correct statement from the list below.

- $(P \cup Q)' = \emptyset$        $P \cup Q = \{3, 6, 9\}$        $P' \subset Q$   
 $10 \notin P \cap Q$        $P' \cap Q = \{5, 7, 10, 11, 13, 14\}$       [1]

(b) Find the number of elements in

(i)  $(P \cup Q)'$ ,

Answer ..... [1]

(ii)  $(P \cup Q) \cap (P \cap Q)'$ .

Answer ..... [1]

[Turn over

17 The diagram shows a quadrilateral  $ABCD$ .

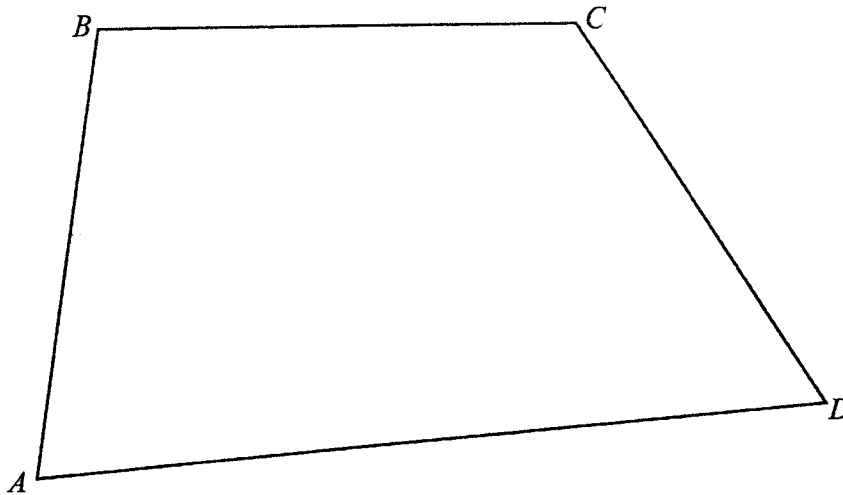

- (a) Construct the perpendicular bisector of  $BC$ . [1]
- (b) Construct the bisector of angle  $ADC$ . [1]
- (c) Point  $K$  is equidistant from  $B$  and  $C$  and equidistant from  $AD$  and  $CD$ .

Mark the point  $K$  on the diagram and measure the length  $BK$ .

Answer  $BK = \dots\dots\dots$  cm [1]

---

18 (a) Simplify  $(81x^{12})^{\frac{3}{4}}$ .

Answer ..... [1]

(b)  $\frac{81^p}{3^q} = 27^r$

Find an expression for  $q$  in terms of  $p$  and  $r$ .

Answer ..... [2]

---

19 (a) Express  $x^2 - 11x + 13$  in the form of  $(x+a)^2 + b$ .

Answer ..... [1]

(b) Hence, solve the equation  $x^2 - 11x + 13 = 0$ , giving your answers to 2 decimal places.

Answer ..... [3]

---

[Turn over

20

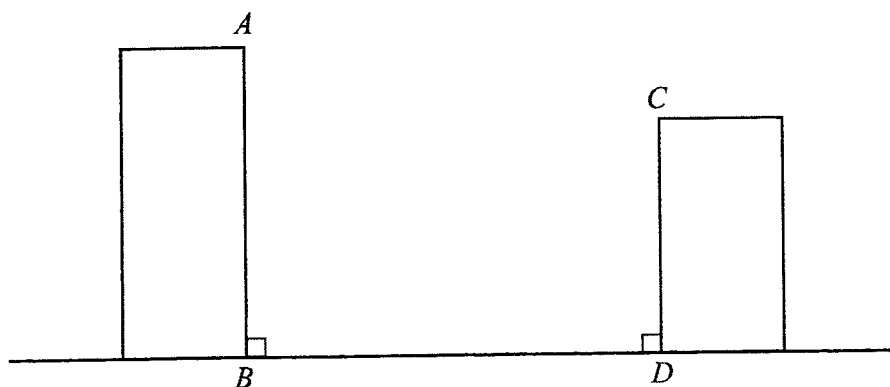

In the diagram,  $AB$  and  $CD$  represents the side of two buildings.

The angle of elevation of  $C$  from  $B$  is  $38^\circ$ .

The angle of depression of  $C$  from  $A$  is  $15^\circ$ .

The height of the side  $CD$  is 44 m.

Find the height of the side  $AB$ .

Answer ..... m [4]

15

- 21 (a) Two integers  $x$  and  $y$  can be expressed as a product of their prime factors as shown below.

$$x = 2^3 \times 3^n \times 5$$

$$y = 2^2 \times 3^2 \times 5^m$$

The lowest common multiple (LCM) of  $x$  and  $y$  is 360.

The highest common factor (HCF) of  $x$  and  $y$  is 60.

Find the values of  $n$  and  $m$ .

*Answer*  $n = \dots\dots\dots$

$m = \dots\dots\dots$  [2]

- (b) The square root of an integer  $z$  is equal to the cube of  $3^2 \times 5^4$ .

Write  $z$  as a product of its prime factors.

*Answer*  $\dots\dots\dots$  [2]

---

[Turn over

22

16

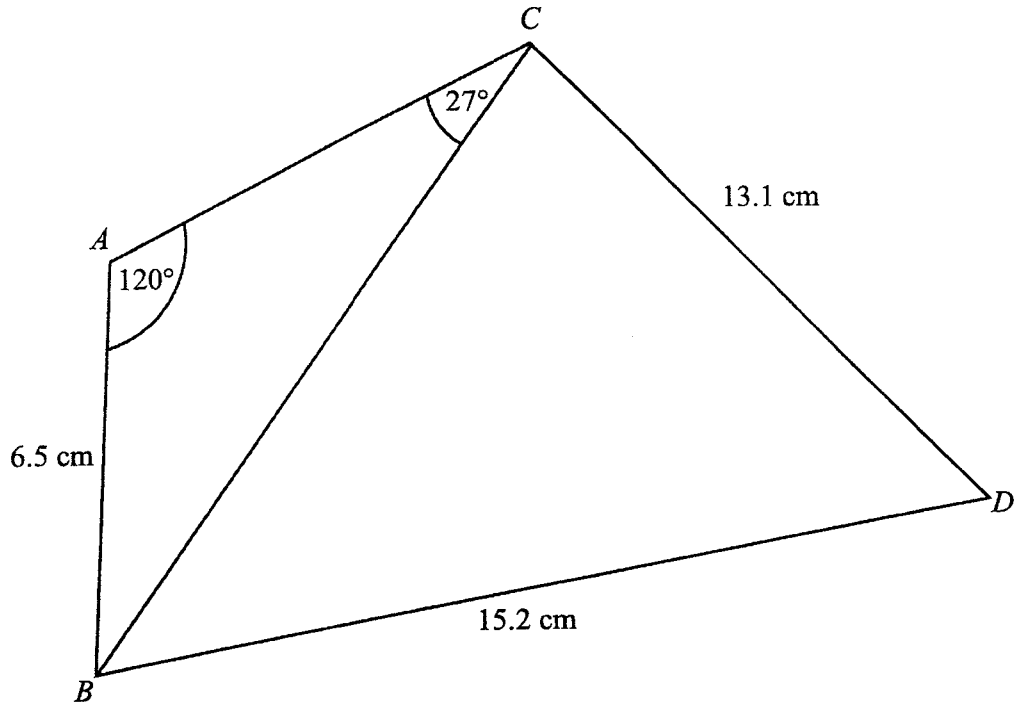

In the quadrilateral,  $AB = 6.5$  cm,  $BD = 15.2$  cm and  $CD = 13.1$  cm.  
Angle  $BAC = 120^\circ$  and angle  $ACB = 27^\circ$ .

(a) Find angle  $BDC$ .

Answer ..... $^\circ$  [4]

(b) Explain whether it is possible to draw a circle through the four vertices  $A, B, C$  and  $D$ .

.....  
.....  
..... [1]



23 An aircraft has three sections, Business Class (B), Premium (P) and Economy (E).

On an outbound flight, there are 14 Business Class passengers,  $x$  Premium passengers and 150 Economy passengers.

On the return flight, there are 15 Business Class passengers, 76 Premium passengers and 143 Economy passengers.

(a) Represent this information in a  $2 \times 3$  matrix,  $S$ .

$$\text{Answer } S = \begin{matrix} & \begin{matrix} B & P & E \end{matrix} \\ \begin{matrix} \text{Outbound} \\ \text{Return} \end{matrix} & \left( \begin{matrix} & & \\ & & \end{matrix} \right) \end{matrix} \quad [1]$$

(b) The cost of the tickets for the Business Class, Premium and Economy seats tickets are \$3200, \$1500 and \$750 respectively.

Find, in terms of  $x$ , the matrix  $T = S \begin{pmatrix} 3200 \\ 1500 \\ 750 \end{pmatrix}$ .

*Answer*  $T =$  [2]

(c) The ticket sales of the return flight is \$3950 more than the ticket sales of the outbound flight.

Find  $x$ .

*Answer*  $x = \dots\dots\dots$  [1]

(d) Another matrix  $N = \begin{pmatrix} 1 & 1 \\ 2 & 2 \end{pmatrix} T$ . Explain what the element in  $N$  could represent.

.....  
 ..... [1]

[Turn over

- 24 (a) Sketch the graph of  $y = 2x^2 - 5x - 3$  on the axes below.  
Indicate clearly the coordinates of the points where the graph crosses the axes and the minimum point on the curve.

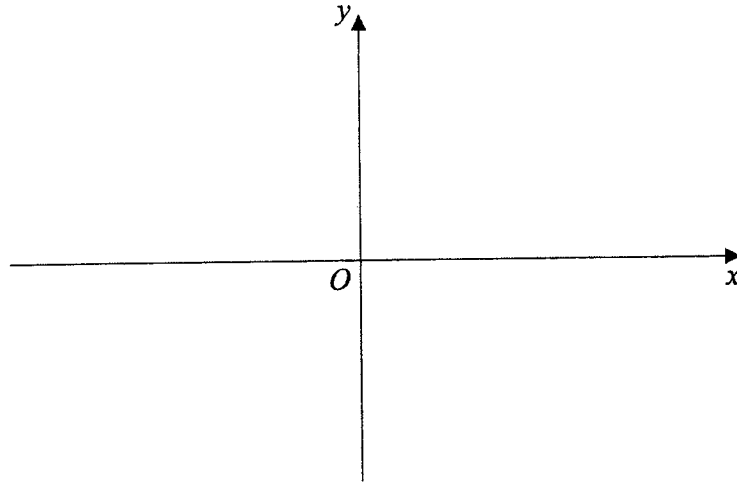

[3]

- (b) Compare and explain the difference between the graph in (a) and the graph  $y = 2x^2 - 5x + 4$ .

.....  
.....  
.....

[1]

25 Car A and B participate in a race.

Car A accelerates uniformly in the first  $T$  seconds and continue at a constant speed before decelerating to a rest in 10 seconds.

Car B accelerates uniformly to a speed of 12 m/s in 19 seconds.

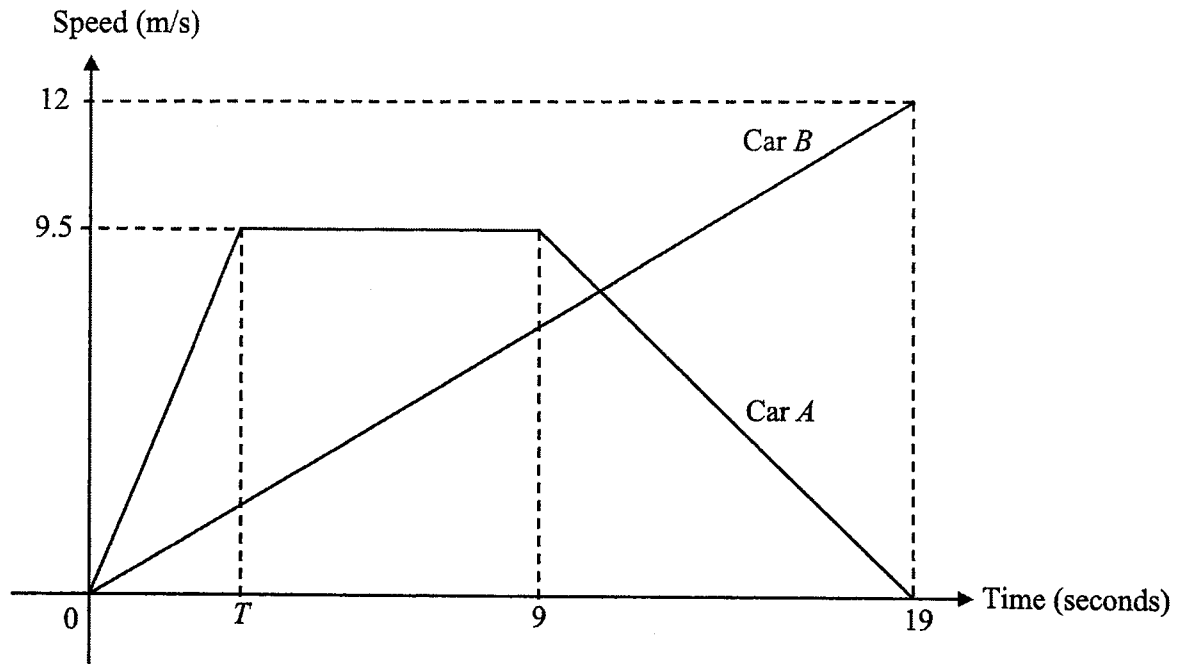

(a) Find the deceleration of car A in the last 10 seconds.

Answer .....  $\text{m/s}^2$  [2]

(b) Given that Car A and B complete the same total distance in 19 seconds. Find the value of  $T$ .

Answer  $T =$  ..... [3]

[Turn over

- (c) Find the time where the speed of car  $A$  is the same as the speed of car  $B$ ,  
 $t \neq 0$  s.

*Answer* ..... s [3]

---

Name: ..... (      )      Class: Sec .....

# Queenstown Secondary School

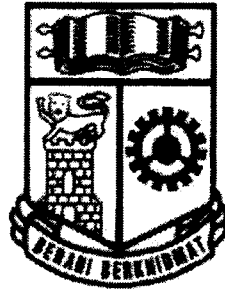

**Preliminary Examination 2022**  
**Secondary Four Express / Five Normal (Academic)**  
**Mathematics Paper 2**  
**4048/02**

**25 August 2022**  
**Thursday**  
**Setter: Mr Chandra**

**Time: 0850 – 1120**  
**Duration: 2 hours 30 minutes**

Candidates answer on the Question Paper.

## READ THESE INSTRUCTIONS FIRST

Write your name, class and index number on all the work you hand in.  
 Write in dark blue or black pen.  
 You may use an HB pencil for any diagrams or graphs.  
 Do not use staples, paper clips, highlighters, glue or correction fluid.

Answer all questions.

If working is needed for any question it must be shown with the answer.  
 Omission of essential working will result in loss of marks.  
 The use of an approved scientific calculator is expected, where appropriate.  
 If the degree of accuracy is not specified in the question, and if the answer is not exact,  
 give the answer to three significant figures. Give answers in degrees to one decimal place.  
 For  $\pi$ , use either your calculator value or 3.142, unless the question requires the answer in  
 terms of  $\pi$ .

The number of marks is given in brackets [ ] at the end of each question or part question.

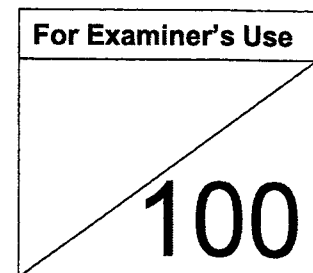

This document consists of **24** printed pages, including this cover page.

**[Turn over**

## 2

**Mathematical Formulae***Compound interest*

$$\text{Total amount} = P \left( 1 + \frac{r}{100} \right)^n$$

*Mensuration*

$$\text{Curved surface area of a cone} = \pi r l$$

$$\text{Surface area of a sphere} = 4\pi r^2$$

$$\text{Volume of a cone} = \frac{1}{3} \pi r^2 h$$

$$\text{Volume of a sphere} = \frac{4}{3} \pi r^3$$

$$\text{Area of a triangle } ABC = \frac{1}{2} ab \sin C$$

$$\text{Arc length} = r\theta, \text{ where } \theta \text{ is in radians}$$

$$\text{Sector area} = \frac{1}{2} r^2 \theta, \text{ where } \theta \text{ is in radians}$$

*Trigonometry*

$$\frac{a}{\sin A} = \frac{b}{\sin B} = \frac{c}{\sin C}$$

$$a^2 = b^2 + c^2 - 2bc \cos A$$

*Statistics*

$$\text{Mean} = \frac{\sum fx}{\sum f}$$

$$\text{Standard deviation} = \sqrt{\frac{\sum fx^2}{\sum f} - \left( \frac{\sum fx}{\sum f} \right)^2}$$

3

- 1 (a) Find the largest prime number  $x$  which satisfies the inequality  $-\frac{1}{4}x > -5$ .

*Answer* ..... [2]

- (b) It is given that  $q = \frac{2}{3}(p^2 - 4r)$ .

- (i) Evaluate  $q$  when  $p = 0.5$  and  $r = -0.25$ .

*Answer*  $q =$  ..... [1]

- (ii) Express  $p$  in terms of  $q$  and  $r$ .

*Answer*  $p =$  ..... [3]

- (c) Solve the equation  $\frac{x}{(3-2x)^2} + \frac{5}{3-2x} = 1$ .

Give your solutions correct to 2 decimal places.

*Answer*  $x =$  ..... or ..... [4]

4

- 2 (a) Singapore received 19.12 million visitors in 2019 before the pandemic restrictions.

Write 19.12 million visitors in standard form correct to 3 significant figures.

*Answer* ..... [1]

- (b) The total tourism spending in 2018 was \$26.94 billion.  
The total tourism spending in 2019 was \$27.69 billion.

Calculate the percentage increase in the total tourism spending from 2018 to 2019.

*Answer* ..... % [2]

- (c) The number of Singapore residents travelling out in 2017 was 9.89 million.  
In 2019 this had increased by 8.08%.

Calculate the number of Singapore residents travelling out in 2019.

*Answer* ..... [2]

- (d) From 2018 to 2021 the number of Singapore residents travelling out decreased by 91.9%.  
In 2021 the number was  $8.33 \times 10^5$ .

Calculate the number of Singapore residents travelling out in 2018.

*Answer* ..... [2]



5

- (e) The cash price of a camera in Singapore is \$870.
- (i) The hire-purchase price of the camera is \$1056.  
The hire-purchase price is a deposit of 20% of the cash price plus  
12 equal monthly payments.
- Calculate one monthly payment.

*Answer* \$ ..... [3]

- (ii) The price of the same camera in UK is £510.  
The exchange rate between Singapore dollars (\$) and UK pounds (£)  
is \$1 = £0.62.

Calculate how much cheaper the camera is in the UK than in  
Singapore.

*Answer* \$ ..... [2]

3

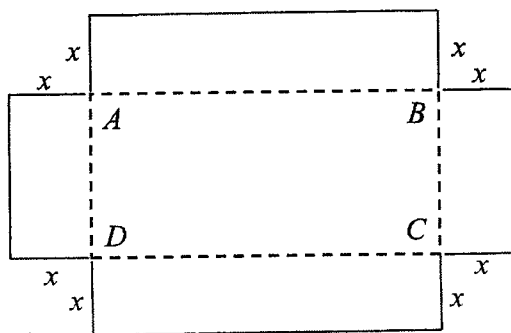

The diagram shows nets of an open box.  
 It is made by cutting a square of side  $x$  from each of the four corners of a rectangular cardboard measuring 20 cm by 30 cm.

(a) Find an expression, in terms of  $x$ , for

(i)  $AB$ ,

*Answer*  $AB = \dots\dots\dots$  cm [1]

(ii)  $BC$ .

*Answer*  $BC = \dots\dots\dots$  cm [1]

(b) If the shape is folded along the dotted lines to make an open box, show that the volume of the box,  $y$  cm<sup>3</sup>, is given by  $y = 4x^3 - 100x^2 + 600x$ .

*Answer*

[2]

(c) Complete the table of values for  $y = 4x^3 - 100x^2 + 600x$ .

$x$	1	2	3	4	5	6	7	8	9
$y$	504	832	1008	1056	1000	864	672		216

[1]

7

- (d) On the grid, draw the graph of  $y = 4x^3 - 100x^2 + 600x$  for  $1 \leq x \leq 9$ .

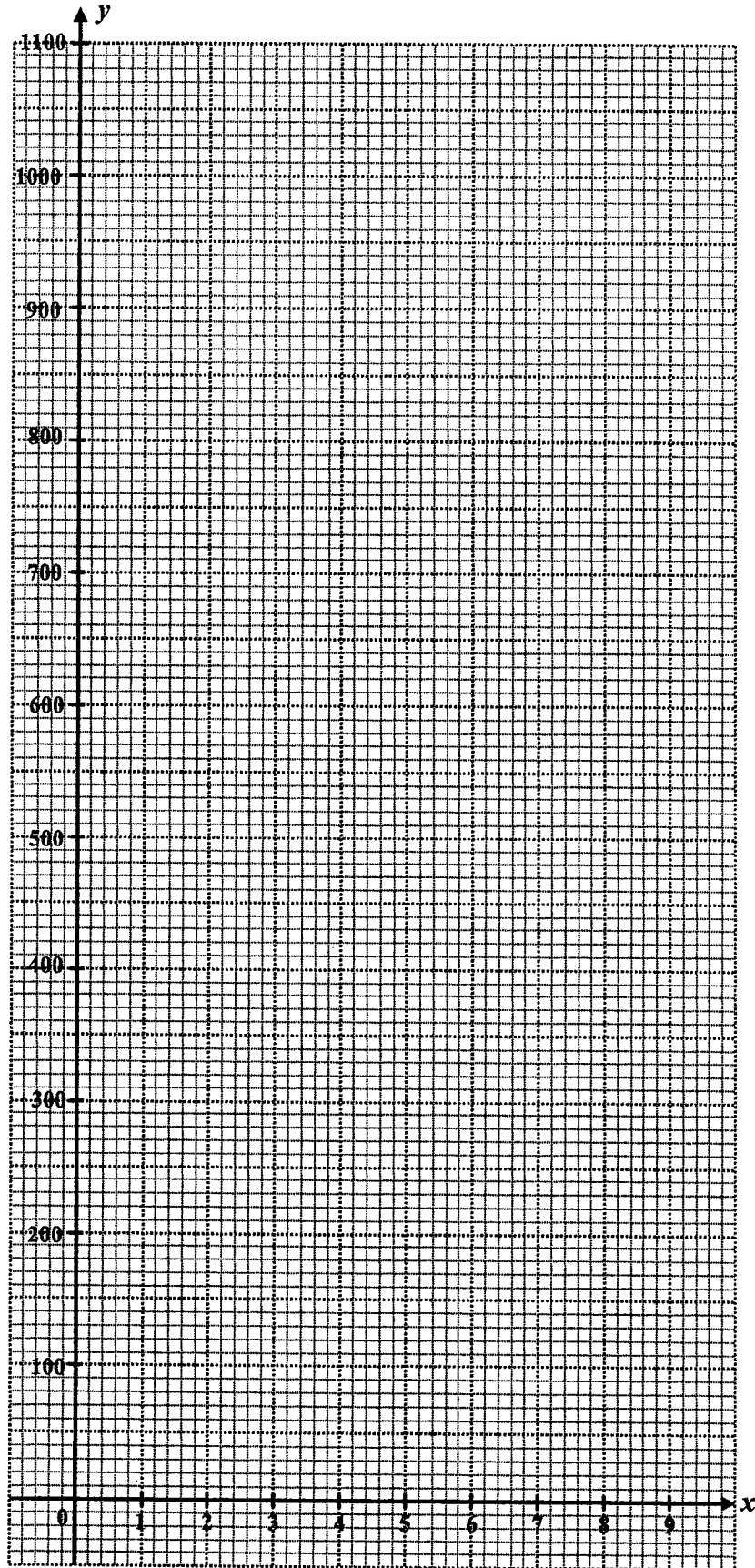

[3]

8

- (e) Use your graph to find the greatest value of  $x$  when the volume of the box is equal to  $800 \text{ cm}^3$ .

*Answer* ..... cm [1]

- (f) Explain how the graph shows that the volume of the box cannot be equal to  $1100 \text{ cm}^3$ .

.....  
.....  
.....  
..... [1]

4

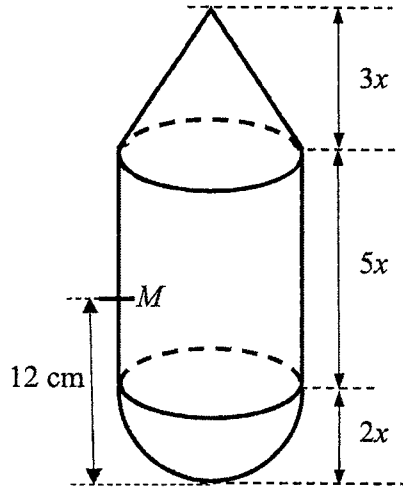

Figure 1

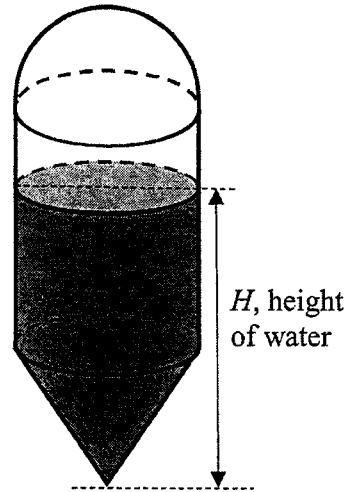

Figure 2

Figure 1 shows a cylindrical container with a cone attached to the top and a hemisphere attached to the bottom.

The cone has height  $3x$  cm.

The cylinder has height  $5x$  cm.

The hemisphere has radius  $2x$  cm.

- (a) The height of the whole solid is 25 cm.  
Show that  $x = 2.5$  cm.

[3]

10

- (b) The container in Figure 1 is filled with water to level  $M$  at a height of 12 cm from the bottom of this container.

Find  $H$ , the height of the water if the container is turned upside down as shown in Figure 2.

*Answer* ..... cm [6]

- 5 A straight line,  $l$ , with equation  $\frac{2x}{a} + \frac{y}{10} = 1$  is parallel to the line  $4x - y = 0$ .

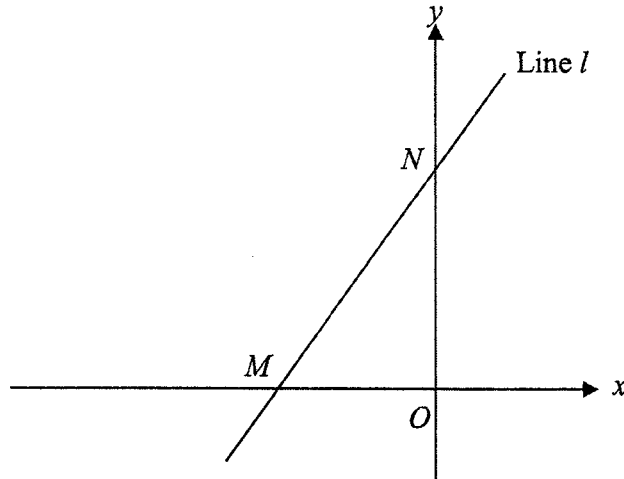

- (a) Show that the value of  $a = -5$ .

[3]

- (b) State the coordinates of points  $M$  and  $N$ , where line  $l$  intersects the  $x$  and  $y$ -axis respectively.

Answer  $M$  (....., .....

$N$  (....., .....) [2]

12

- (c) Find the perpendicular distance from this line  $l$  to the origin.

*Answer* ..... units [2]

- (d) Line  $4x - y = 0$  intersects the line  $y = 10$  at point  $P$ .

Explain why  $MNPO$  is a parallelogram.

.....  
 .....  
 ..... [2]

- (e) Calculate the area of parallelogram  $MNPO$ .

*Answer* ..... units<sup>2</sup> [2]



- 6 The diagram shows a circle  $RQPTS$ , centre  $O$ .  
 $UPV$  is a tangent to the circle. The chord  $PR$  and the diameter  $SQ$  intersect at  $X$ .  
 Angle  $PTS = 122^\circ$  and angle  $QSR = 28^\circ$ .

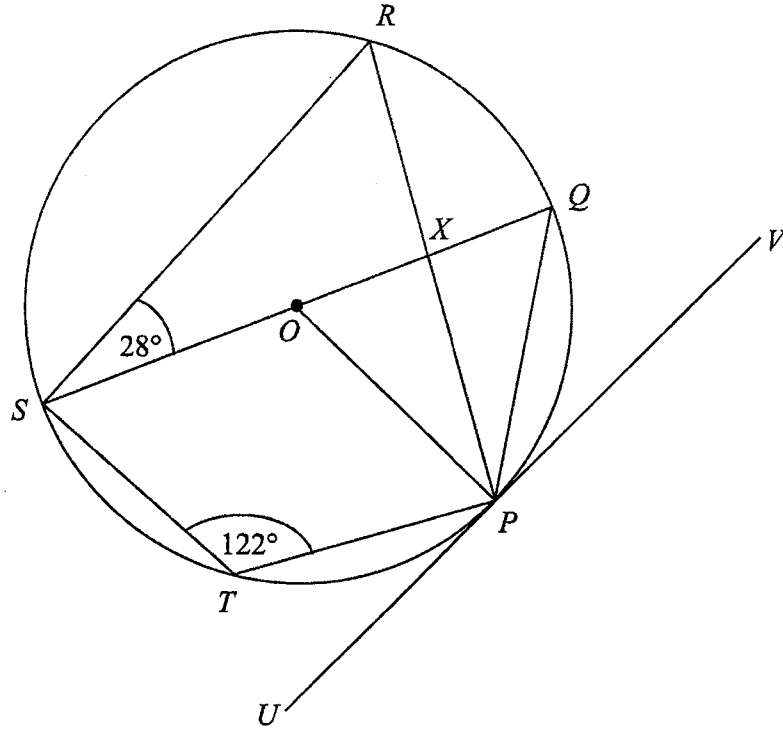

- (a) Find angle  $RXS$ .  
 Give a reason for each step of your working.

*Answer* Angle  $RXS = \dots\dots\dots$  [2]

- (b) Find angle  $QPV$ .  
 Give a reason for each step of your working.

*Answer* Angle  $QPV = \dots\dots\dots$  [4]

14

- (c)  $SQ = 10$  cm.  
Calculate the area of the major sector  $OSRQP$ .

*Answer* .....  $\text{cm}^2$  [3]

15

7 The first four terms in a sequence of numbers,  $T_1, T_2, T_3, T_4, \dots$  are given below.

$$T_1 = 1^2 + 4 = 5$$

$$T_2 = 2^2 + 8 = 12$$

$$T_3 = 3^2 + 12 = 21$$

$$T_4 = 4^2 + 16 = 32$$

(a) Find the fifth term of the sequence.

*Answer* ..... [1]

(b) Find an expression, in terms of  $n$ , for  $T_n$ .

*Answer*  $T_n = \dots\dots\dots$  [2]

- (c) The difference,  $D$ , between two consecutive terms of the sequence is  $T_{n+1} - T_n$ .

Show that  $D = 2n + 5$ .

[3]

- (d) Explain why the difference between two consecutive terms of the sequence is always odd.

*Answer*.....  
.....  
.....

[1]

17

8 (a) The position vector of point  $R$  is  $\begin{pmatrix} -5 \\ -1 \end{pmatrix}$ .

The position vector of point  $S$  is  $\begin{pmatrix} 7 \\ 2 \end{pmatrix}$ .

(i) Find the magnitude of  $\overline{RS}$ .

*Answer* ..... [2]

(ii)  $T$  is the point on  $RS$  with coordinates  $(k, 5)$ .  
Find the position vector of  $T$ .

*Answer*  $\begin{pmatrix} \phantom{0} \\ \phantom{0} \end{pmatrix}$  [3]

(b)

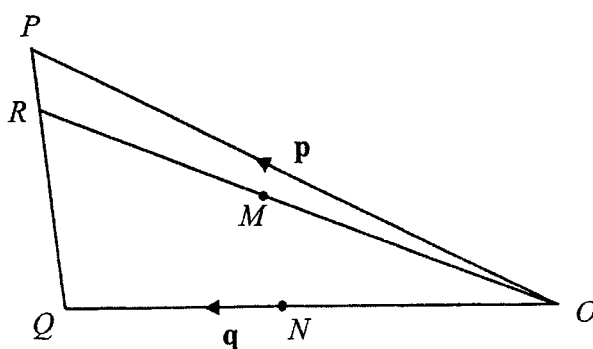

$OPQ$  is a triangle.

$\overrightarrow{OP} = \mathbf{p}$  and  $\overrightarrow{OQ} = \mathbf{q}$ .

$R$  is the point on  $PQ$  such that  $PR : RQ = 1 : 4$ .

$M$  and  $N$  are the midpoints of  $OR$  and  $OQ$  respectively.

(i) Express  $\overrightarrow{PR}$  in terms of  $\mathbf{p}$  and  $\mathbf{q}$ , as simply as possible.

Answer ..... [2]

(ii) Express  $\overrightarrow{OM}$  in terms of  $\mathbf{p}$  and  $\mathbf{q}$ , as simply as possible.

Answer ..... [2]

(iii) What type of quadrilateral is  $RQNM$ ?  
Justify your answer using vectors.

..... because .....

..... [3]

- 9 (a) A fruit distribution company recorded the masses of 200 pears in a cold storage room.  
The cumulative frequency curve shows the distribution of the results.

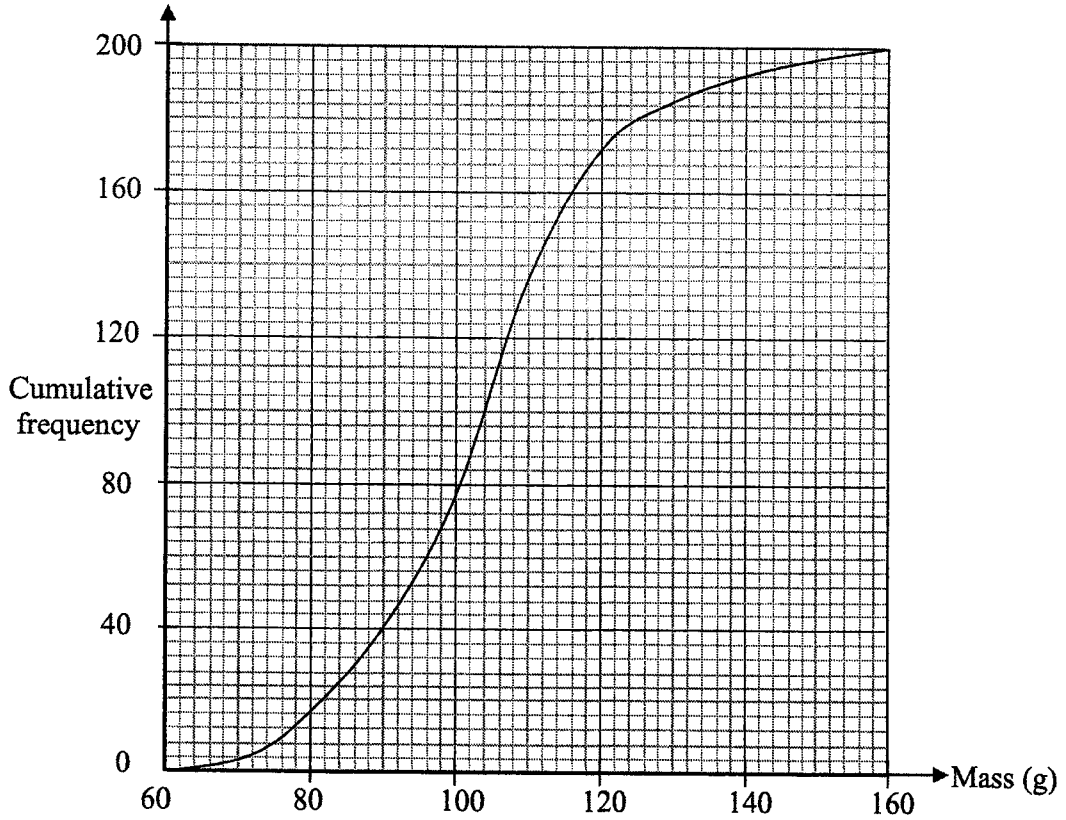

- (i) Use the curve to estimate  
(a) the median mass,

Answer ..... g [1]

- (b) the interquartile range of the masses.

Answer ..... g [2]

20

- (ii) The distribution company only delivers pears with a mass in between 80 g and 120 g from the storage room to supermarket and rejects the rest.

Calculate the percentage of the pears from the storage room delivered to the supermarket.

*Answer* ..... % [2]

- (iii) Several days later, it was discovered that the weighing machine had been faulty and was 20 g more.

State the correct value of

- (a) the median mass,

*Answer* ..... g [1]

- (b) the interquartile range of masses.

*Answer* ..... g [1]



21

(b) The fruit distribution company employs 15 workers.

One of the 15 workers is selected at random.

The probability that it is a woman working part time is  $\frac{1}{5}$ .

Two of the 15 workers are selected at random.

The probability that they are both men working full time is  $\frac{1}{5}$ .

Complete the table of information about the 15 workers in the company.

	Part-time workers	Full-time workers
Men		
Women		4

[3]

- 10 Tomi is planning his exercise routine.  
He records his body mass and average speeds for running and cycling.

Body mass	80 kg
Running speed	11 km/h
Leisure cycling speed	12 km/h

**Health advice**

For **recommended health benefits**, adults should do at least 150 minutes of moderate intensity aerobic activity or at least 75 minutes of vigorous-intensity aerobic activity each week.

For **additional health benefits**, adults should increase their moderate-intensity aerobic activity to 300 minutes each week or an equivalent combination of moderate- and vigorous-intensity aerobic activity.

Running is considered vigorous-intensity aerobic activity.  
Leisure cycling is considered moderate-intensity aerobic activity.

1 minute of vigorous-intensity aerobic activity = 2 minutes of moderate-intensity aerobic activity, e.g. 10 minutes of running = 20 minutes of leisure cycling.

A scientific research in the table below shows the approximate calories used during 30 minutes of aerobic exercise for different body masses.

	Body mass			
	60 kg	70 kg	80 kg	90 kg
Leisure cycling 10 km/h	150	165	180	195
Leisure cycling 12 km/h	175	200	220	240
Running 10 km/h	350	380	410	450
Running 11 km/h	400	450	500	550

- (a) In his first week of exercise, Tomi plans to go for 3 sessions of leisure cycling. He will cycle the same route each time.  
The three sessions of cycling meet the time for recommended health benefits in one week.
- (i) Work out the distance of one of these cycling sessions.

Answer ..... km [2]

- (ii) Work out how many calories Tomi uses in these 3 leisure cycling sessions.

*Answer* ..... calories [2]

- (b) After one month Tomi changes his routine.

Tomi aims to achieve additional health benefits.  
He decides to do a 12 km leisure cycling 2 times each week and do a 5 km run 4 times each week.

Tomi says that he is able to achieve additional health benefits following the new routine.

Is Tomi correct?  
Justify your decision with calculations.

.....  
.....

[6]