

Name

Reg. No

Class



MAYFLOWER SECONDARY SCHOOL MAYFLOWER SECONDARY SCHOOL MAYFLOWER SECONDARY SCHOOL MAYFLOWER SECONDARY SCHOOL MAYFLOWER SECONDARY SCHOOL  
MAYFLOWER SECONDARY SCHOOL MAYFLOWER SECONDARY SCHOOL MAYFLOWER SECONDARY SCHOOL MAYFLOWER SECONDARY SCHOOL MAYFLOWER SECONDARY SCHOOL  
MAYFLOWER SECONDARY SCHOOL MAYFLOWER SECONDARY SCHOOL MAYFLOWER SECONDARY SCHOOL MAYFLOWER SECONDARY SCHOOL MAYFLOWER SECONDARY SCHOOL  
MAYFLOWER SECONDARY SCHOOL MAYFLOWER SECONDARY SCHOOL MAYFLOWER SECONDARY SCHOOL MAYFLOWER SECONDARY SCHOOL MAYFLOWER SECONDARY SCHOOL  
MAYFLOWER SECONDARY SCHOOL MAYFLOWER SECONDARY SCHOOL MAYFLOWER SECONDARY SCHOOL MAYFLOWER SECONDARY SCHOOL MAYFLOWER SECONDARY SCHOOL  
MAYFLOWER SECONDARY SCHOOL MAYFLOWER SECONDARY SCHOOL MAYFLOWER SECONDARY SCHOOL MAYFLOWER SECONDARY SCHOOL MAYFLOWER SECONDARY SCHOOL  
MAYFLOWER SECONDARY SCHOOL MAYFLOWER SECONDARY SCHOOL MAYFLOWER SECONDARY SCHOOL MAYFLOWER SECONDARY SCHOOL MAYFLOWER SECONDARY SCHOOL  
MAYFLOWER SECONDARY SCHOOL MAYFLOWER SECONDARY SCHOOL MAYFLOWER SECONDARY SCHOOL MAYFLOWER SECONDARY SCHOOL MAYFLOWER SECONDARY SCHOOL

**4EX****BIOLOGY****6093/01**

Paper 1 Multiple Choice [40 Marks]

**PRELIMINARY EXAMINATIONS****August 2024**

Additional Materials:  
Approved calculator  
OTAS

**1 hour****Instruction to Candidates**

Do not start reading the questions until you are told to do so.

Write in soft pencil.

Do not use staples, paper clips, highlighters, glue or correction fluid.

Write your name, class, and index number on the OTAS provided.

**Information for Candidates**

There are **forty** questions on this paper. Answer **all** questions.

For each question, there are four possible answers **A, B, C** and **D**.

Choose the **one** you consider correct and record your choice in **soft pencil** on the OTAS.

**Read the instructions on the OTAS very carefully.**

Each correct answer will score one mark. A mark will not be deducted for a wrong answer.

The use of an approved scientific calculator is expected, where appropriate.

---

This question paper consists of **18** printed pages.

---

**Paper 1 (40 marks)**

Answer all questions in the OTAS provided.

The diagram below shows two plant cells, X and Y. Cell X has a higher water potential than Y.

Use this information to answer questions 1 and 2.

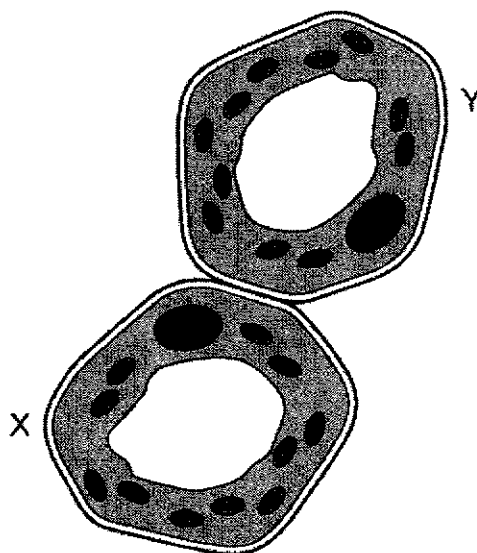

- 1 What process will occur between these two cells?
- A active transport  
 B diffusion  
 C osmosis  
 D transpiration
- 2 Which row identifies the direction and the reason for movement of substances between X and Y?

	<b>Direction</b>	<b>Reason</b>
<b>A</b>	<b>X to Y</b>	Salt molecules move from X to Y because there is a higher concentration of salt molecules at X.
<b>B</b>	<b>X to Y</b>	Water molecules move from X to Y because there is a higher water potential at X.
<b>C</b>	<b>Y to X</b>	Salt molecules move from Y to X because there is a higher concentration of salt molecules at Y.
<b>D</b>	<b>Y to X</b>	Water molecules move from Y to X because there is a higher water potential at Y.

The diagram below shows an experiment.

Use this information to answer questions 3 and 4.

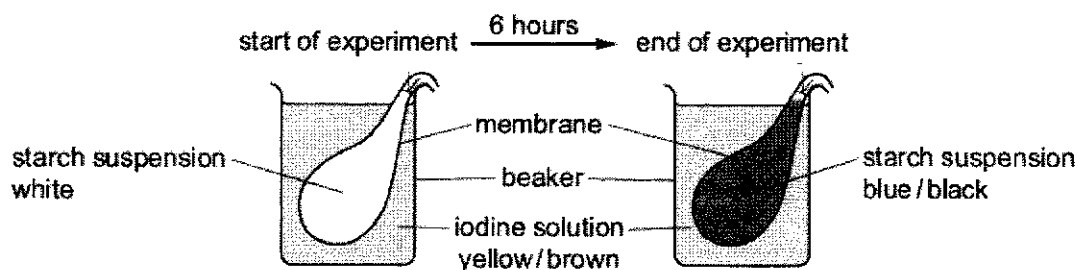

- 3 Why did the starch suspension change colour?
- A Iodine molecules diffused in through the membrane.  
 B Iodine molecules diffused out through the membrane.  
 C Starch molecules diffused in through the membrane.  
 D Starch molecules diffused out through the membrane.
- 4 Which method can increase the rate of reaction in this experiment?
- A Adding amylase into the iodine solution.  
 B Adding amylase into the starch suspension.  
 C Decreasing the temperature of the set up.  
 D Increasing the temperature the set up.
- 5 The following diagram shows a portion of a starch molecule.



Which diagram represents the outcome of the digestion of the starch molecule by amylase?

- A
- B
- C
- D

- 6 Several food tests were conducted on a sample of an isotonic drink.

Which row is an expected result?

	Benedict's test	Biuret test	Iodine test
<b>A</b>	brick-red precipitate formed	solution remains blue	solution remains yellow
<b>B</b>	solution turns violet	brick-red precipitate formed	solution remains blue
<b>C</b>	solution turns violet	solution remains blue	solution remains yellow
<b>D</b>	solution remains blue	brick-red precipitate formed	solution remains yellow

- 7 Three potato strips (X, Y and Z) with the same mass were placed into three different solutions for one hour. The mass of the three potato strips were then compared using a beam balance. The results are shown in the diagram below.

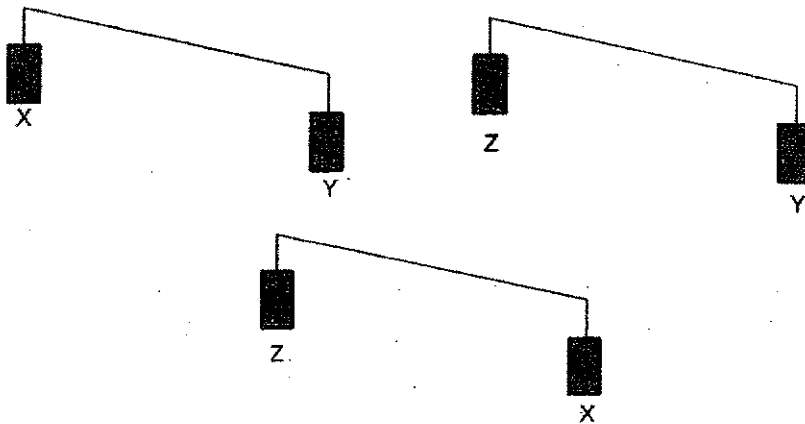

Which row identifies the solution each potato strip is placed in?

	X	Y	Z
<b>A</b>	10% sucrose solution	25% sucrose solution	distilled water
<b>B</b>	10% sucrose solution	distilled water	25% sucrose solution
<b>C</b>	25% sucrose solution	distilled water	10% sucrose solution
<b>D</b>	25% sucrose solution	10% sucrose solution	distilled water

- 8 Which statement describes enzyme-catalysed reactions?
- A All enzymes work best at 37°C.
  - B As an enzyme-catalysed reaction progresses, the concentration of reactants increases.
  - C As the temperature of an enzyme-catalysed reaction increases from 0°C to 20°C, the frequency of effective collisions increases.
  - D Enzymes are denatured as the temperature of an enzyme-catalysed reaction is lowered from 20°C to 0°C.
- 9 The diagram shows the blood supply of the liver.

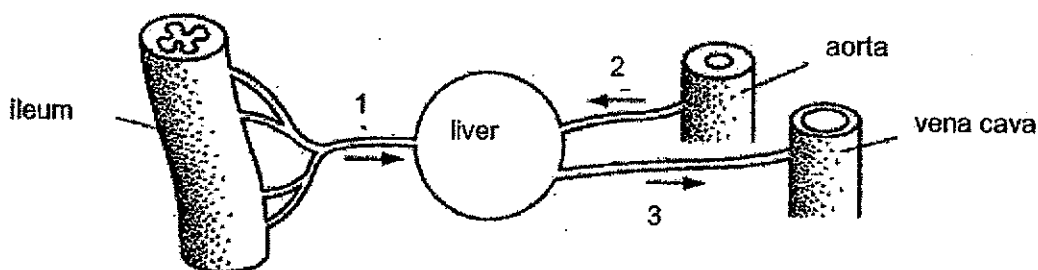

Which row identifies blood vessel 1, 2 and 3?

	1	2	3
A	hepatic artery	hepatic portal vein	hepatic vein
B	hepatic artery	hepatic vein	hepatic portal vein
C	hepatic portal vein	hepatic artery	hepatic vein
D	hepatic portal vein	hepatic vein	hepatic artery

- 10 What is not likely to be an outcome of the removal of the pancreas?
- A decrease in the amount of glycogen production in liver and muscle cells
  - B decrease in the amount of protein digested
  - C diabetes mellitus
  - D increase in the pH of duodenum

11 The following statements were made.

- 1 the intake of food into the body through the mouth
- 2 the breakdown of large insoluble food molecules into small soluble ones
- 3 the uptake and use of food molecules in the cells of the body
- 4 the movement of food molecules through the wall of the intestine

Which row matches the definitions of digestion and assimilation?

	digestion	assimilation
<b>A</b>	1	3
<b>B</b>	2	3
<b>C</b>	1	4
<b>D</b>	2	4

12 The following diagram shows a section of the coronary artery with deposition of fats that may result in a heart attack.

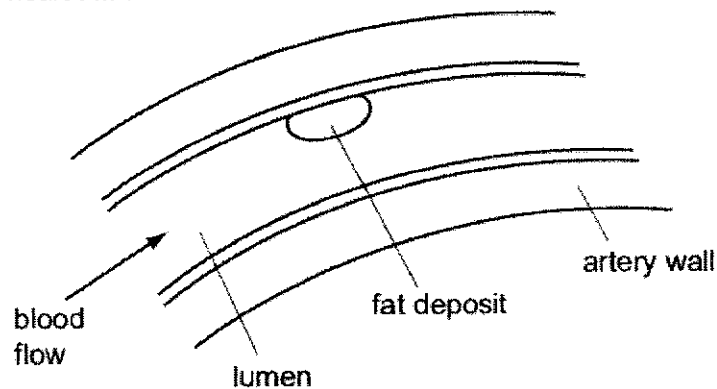

What statement describes the events that could lead to a heart attack?

- A** Further fat deposits followed by platelet destruction.
- B** Further fat deposits followed by red blood cell destruction.
- C** Restriction of the artery lumen causing less oxygen supply.
- D** Hardening the artery wall preventing diffusion across the wall.

- 13 The graph shows changes in the air pressure within the lungs during one breathing cycle.

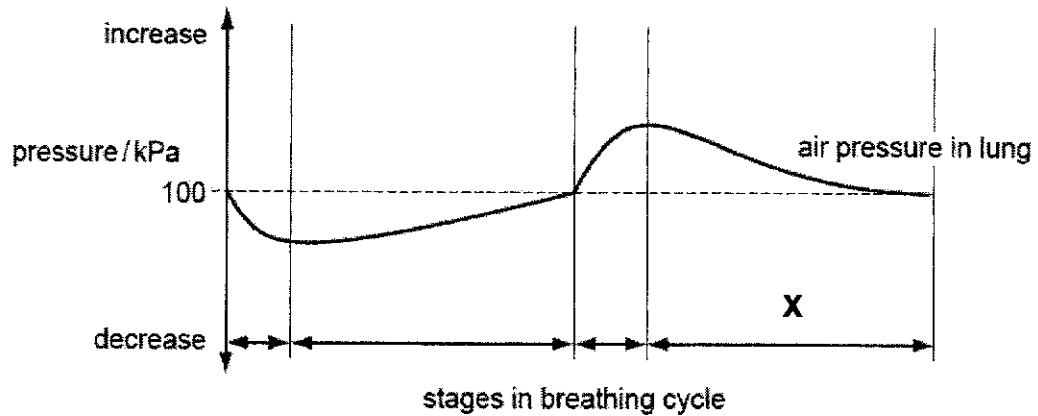

What causes the change in air pressure during stage X?

- A contraction of diaphragm
  - B movement of ribs upwards and outwards
  - C relaxation of external intercostal muscles
  - B relaxation of internal intercostal muscles
- 14 The diagram gives information about blood pressure in various parts of the circulatory system during the cardiac cycle.

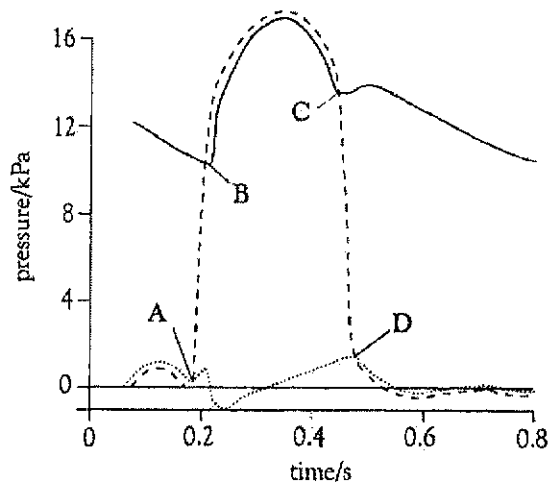

key  
 — aorta  
 ..... atrium  
 ---- ventricle

At which point does the semilunar valve of the aorta close?

- 15 The diagram shows an apparatus used to measure the respiration rate of small animals.

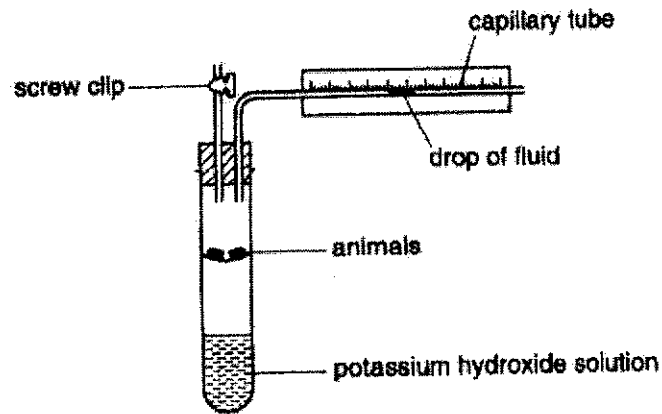

Which row correctly states and explains if the screw clip should be left open or closed?

	screw clip	reason
A	closed	to measure output of carbon dioxide
B	closed	to measure uptake of oxygen
C	open	to allow entry of air
D	open	to allow for temperature fluctuations

- 16 The graph shows changes in the pH of water in a freshwater lake on a summer's day. Y represents midday.

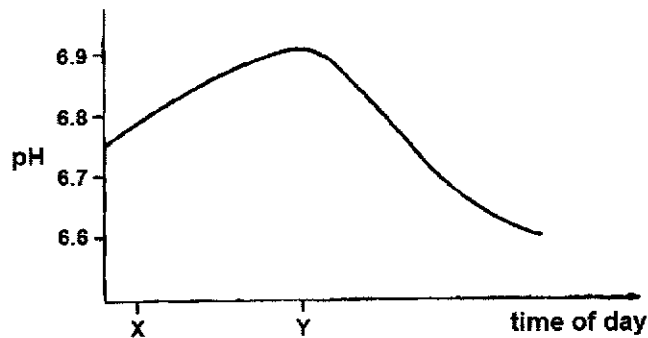

Which statement explains the shape of the graph between time X and Y?

- A decreased levels of carbon dioxide due to photosynthesis
- B increased biological oxygen demand by consumers
- C increased levels of carbon dioxide due to respiration
- D increased oxygen released by producers



- 17 Coypu are found in fresh water and are never short of water to drink. Brown rats can go some days without drinking. Kangaroo rats can live in deserts without drinking for months.

The diagram shows vertical sections of kidneys of coypu, brown rat and kangaroo rat, showing the relative sizes of cortex and medulla.

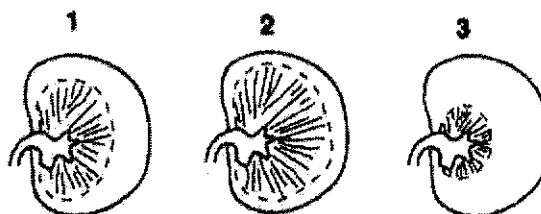

Which row correctly identifies the animal which the kidney belongs to?

	1	2	3
A	brown rat	coypu	kangaroo rat
B	brown rat	kangaroo rat	coypu
C	kangaroo rat	brown rat	coypu
D	kangaroo rat	coypu	brown rat

- 18 The graph shows how the rate of transpiration is affected by X.

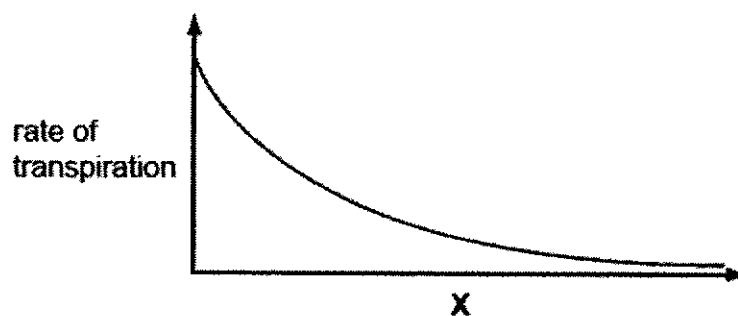

What is X?

- A humidity
- B light intensity
- C soil moisture
- D temperature

- 19 The graph below shows the effects of varying the carbon dioxide concentration at two different light intensities on the rate of photosynthesis.

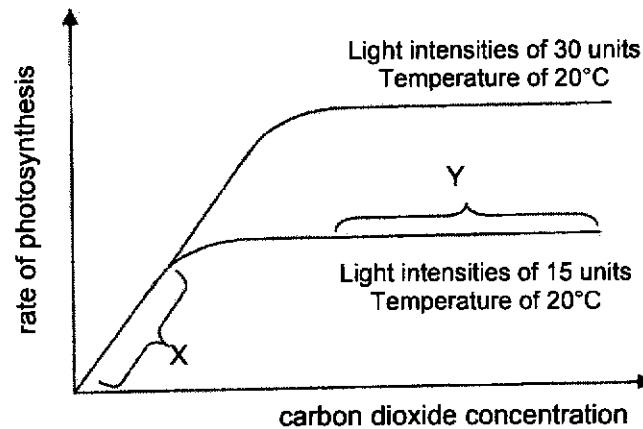

What are the limiting factors of regions X and Y?

	region X	region Y
A	carbon dioxide concentration	light intensity
B	carbon dioxide concentration	temperature
C	light intensity	carbon dioxide concentration
D	light intensity	temperature

- 20 Which statement explains why removing a complete ring of bark from the branch of a fruit tree results in the production of larger fruits at the branch?
- A Less organic nutrients are transported away from the branches.  
 B More minerals can be transported to the branches to support growth.  
 C More oxygen can enter the branches to facilitate energy release.  
 D More water can be transported to the branches to support growth.
- 21 The trigeminal nerve in humans connects the brain with the teeth and the skin on the face. When the dentist administers a local anaesthesia by injection, you can no longer feel pain and you cannot smile properly.

Which statement correctly explains the effects of the local anaesthesia?

- A The trigeminal nerve carries impulses from the brain to the teeth and back.  
 B The trigeminal nerve contains motor neurones.  
 C The trigeminal nerve contains motor and sensory neurones.  
 D The trigeminal nerve contains sensory neurones.

- 22 The diagram shows an experiment set up to measure the rate of photosynthesis.

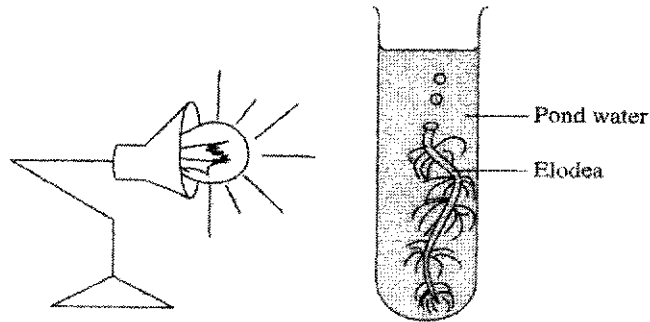

Which row correctly states the conditions that cause *Elodea* to photosynthesize at a maximum rate?

	Distance (cm)	Amount of sodium bicarbonate (g)	Temperature (°C)
<b>A</b>	10	5	35
<b>B</b>	10	5	50
<b>C</b>	20	5	35
<b>D</b>	10	0	35

- 23 Li Tao looks out of the window at the palm tree in the quadrangle. He turns and reads the time on his wrist watch, glances at the teacher in front of the class and runs out of the classroom through the back door.

Which diagram shows the sequence of the changes in the shape of the lens of his eyes?

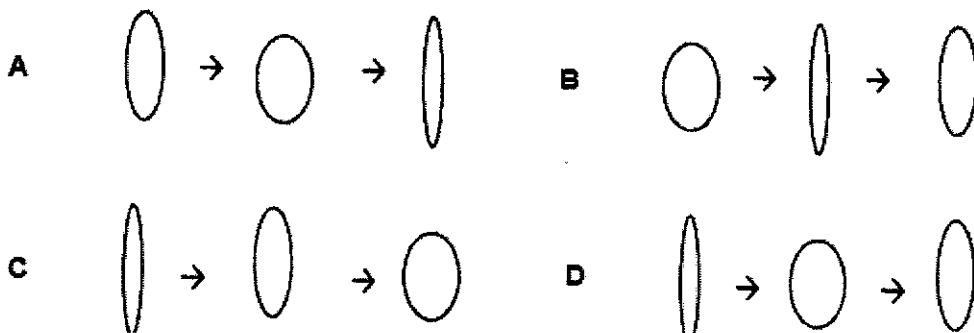

24 The diagram below shows the front view of the eye.

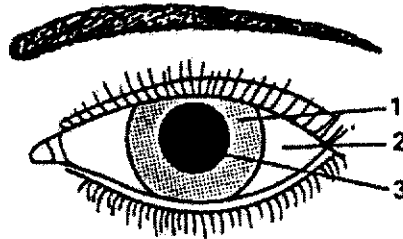

Which row shows the correct labels of the structures?

	1	2	3
<b>A</b>	cornea	choroid	iris
<b>B</b>	cornea	retina	choroid
<b>C</b>	iris	retina	pupil
<b>D</b>	iris	sclera	pupil

25 The graphs show changes in the rate of heartbeat and in the concentration of sugar in the blood over the same period of time.

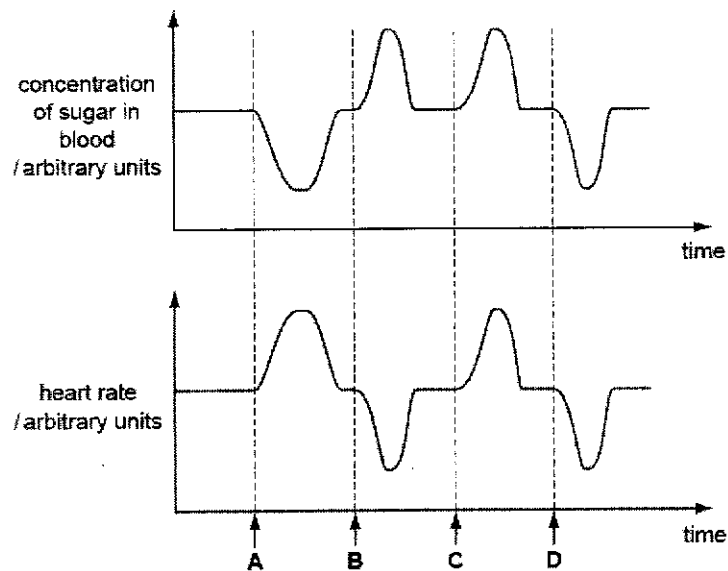

Which arrow represents the time when adrenaline is secreted?

- 26 What is the difference between Acquired Immune Deficiency Syndrome and influenza?
- A Acquired Immune Deficiency Syndrome is caused by a bacterium while influenza is caused by a virus.
  - B Acquired Immune Deficiency Syndrome is caused by a virus while influenza is caused by a bacterium.
  - C Both diseases can be treated by antibiotics.
  - D Both diseases cannot be treated by antibiotics.
- 27 The food chain below is found in a forest.

**Tree → Maggot → Bird → Intestinal parasite**

Four ecological pyramids are shown below.

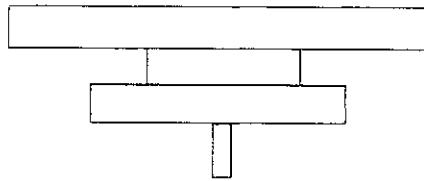

1

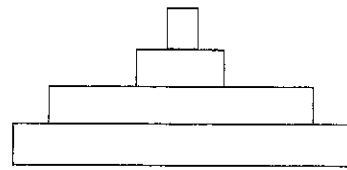

2

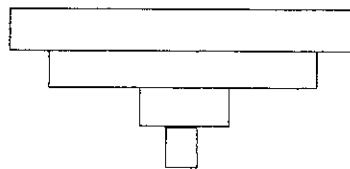

3

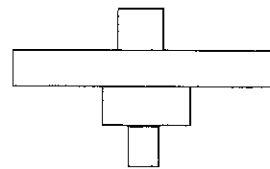

4

Which row correctly represents the pyramid of numbers and the pyramid of biomass of this food chain?

	Pyramid of numbers	Pyramid of biomass
A	2	2
B	1	2
C	4	2
D	3	4

- 28 The diagram shows the carbon cycle.

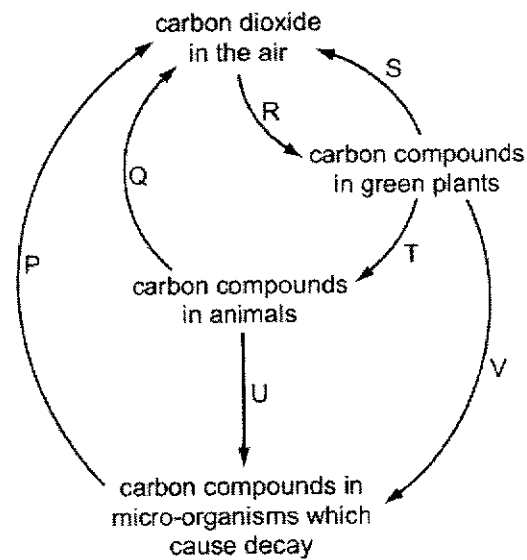

Which letters represent respiration?

- A P, Q and R  
 B P, Q and S  
 C S, T and V  
 D T, U and V
- 29 The map below shows a river flowing into the sea. The river is polluted by untreated sewage.

At which labelled point will the oxygen content of the water be the lowest?

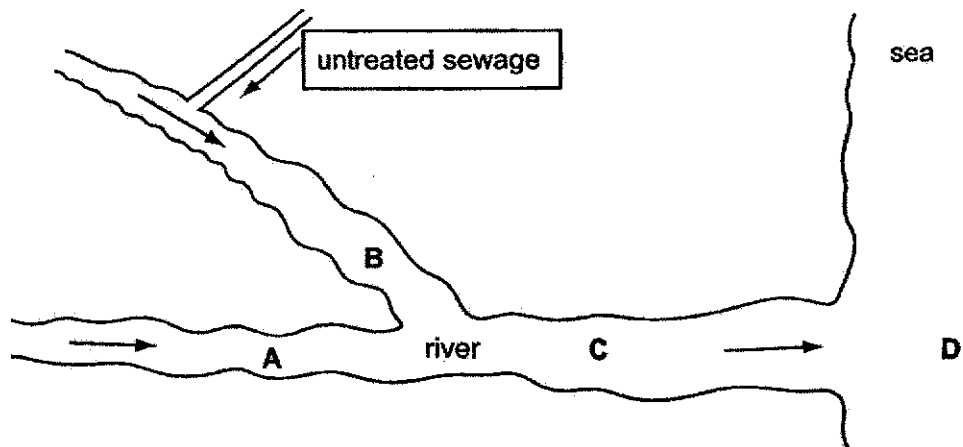

- 30 Which of the following is not a valid example of evolution by means of natural selection?
- A Development of antibiotic-resistance bacteria.
  - B Development of birds with different kinds of beaks for different food sources.
  - C Development of giraffes with longer necks as earlier generations stretched their necks more to obtain food.
  - D Development of orchids with different flower shapes that attract specific pollinators.
- 31 The diagram shows the main stages in a process where a liver cell from one rabbit is used to provide a nucleus, which was then placed into the egg of another rabbit.

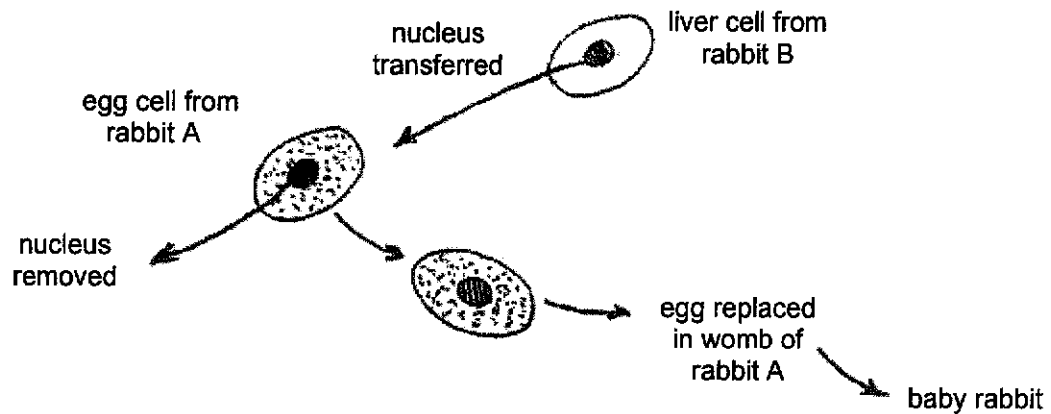

Which statement best describe the appearance of the baby rabbit?

- A The baby rabbit looks like both rabbit A and B.
  - B The baby rabbit looks like rabbit A.
  - C The baby rabbit looks like rabbit B.
  - D The baby rabbit will not look like both rabbit A or B.
- 32 Which statement of cross-pollination is the most accurate?
- A It can involve flowers on the same plant or different plants of the same species.
  - B It must involve different plants of different species.
  - C It must involve different plants of the same species.
  - D It must involve two flowers.
- 33 Which microbes are used in the treatment of sewage?
- A bacteria only
  - B bacteria and virus
  - C fungi only
  - D fungi and virus

- 34 The diagram shows a section through a flower.

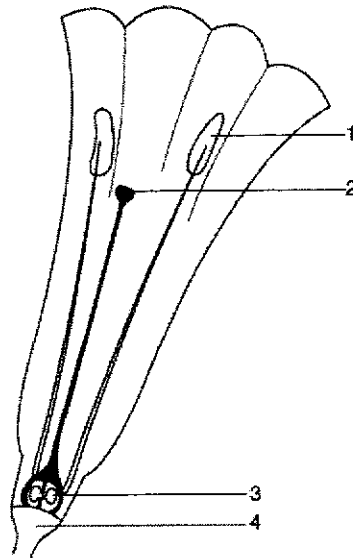

Which labelled parts contain haploid nuclei formed by reduction division?

- A 1 and 2  
 B 1 and 3  
 C 2 and 3  
 D 2 and 4
- 35 The diagram below shows the life cycle of an animal.

Which arrow best represents mitosis?

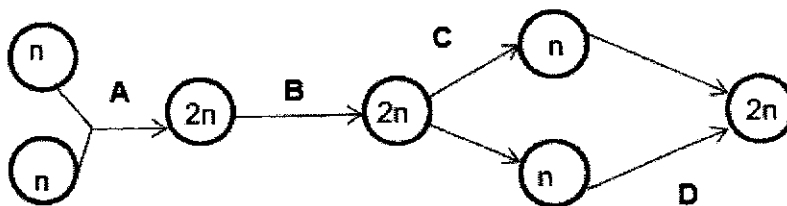

- 36 Which method would most likely produce flowers of the same type and colour?
- A Growing all the plants from the seeds from one parent plant.  
 B Growing all the plants from the cutting from one parent plant.  
 C Growing all the plants in the same conditions.  
 D Growing flowers from the same plant can never be identical.



The graph shows the hormone changes during a normal menstrual cycle.

Refer to the graph to answer questions 37 and 38.

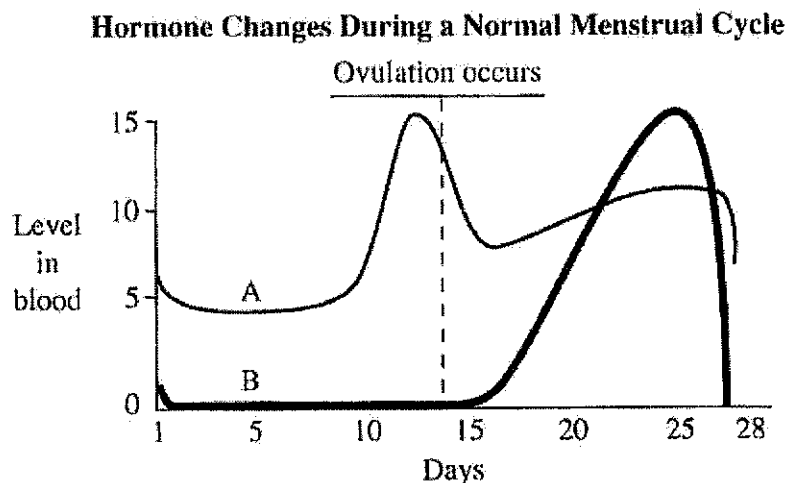

37 Which row correctly identifies the hormones and its graph?

	Graph A	Graph B
<b>A</b>	progesterone	oestrogen
<b>B</b>	progesterone	testosterone
<b>C</b>	oestrogen	progesterone
<b>D</b>	oestrogen	testosterone

38 What would be a likely consequence if the hormone represented by graph B is lacking in a adult female?

- A** The adult's uterine lining might not be sufficiently stable to support an implanted embryo.
- B** The levels of the hormone represented by graph B would be higher than normal.
- C** There would be a delay in puberty.
- D** There would be no significant effect since the functions of the hormones overlap.

Polydactyly is a genetically inherited abnormality caused by a dominant allele, D. Affected individuals have one or more extra digits on the hand or feet.

The diagram below that shows the pedigree chart of a family. Refer to the diagram to answer questions 39 and 40.

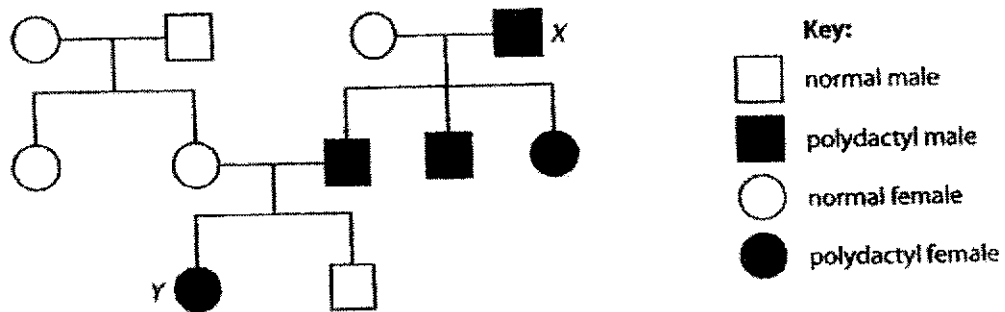

39 What is the genotype of X?

- A DD
- B Dd
- C dD
- D dd

40 If Y marries a man who is heterozygous for polydactyl, what would be the probability that their first child is polydactyl?

- A 0%
- B 25%
- C 75%
- D 100%

## Answers

1	2	3	4	5	6	7	8	9	10
C	B	A	D	C	A	B	C	C	D

11	12	13	14	15	16	17	18	19	20
B	C	C	C	B	A	B	A	A	A

21	22	23	24	25	26	27	28	29	30
C	A	D	D	C	D	B	B	B	A

31	32	33	34	35	36	37	38	39	40
C	C	A	B	B	B	C	A	A	C

